

BASE: 6 SURFACE

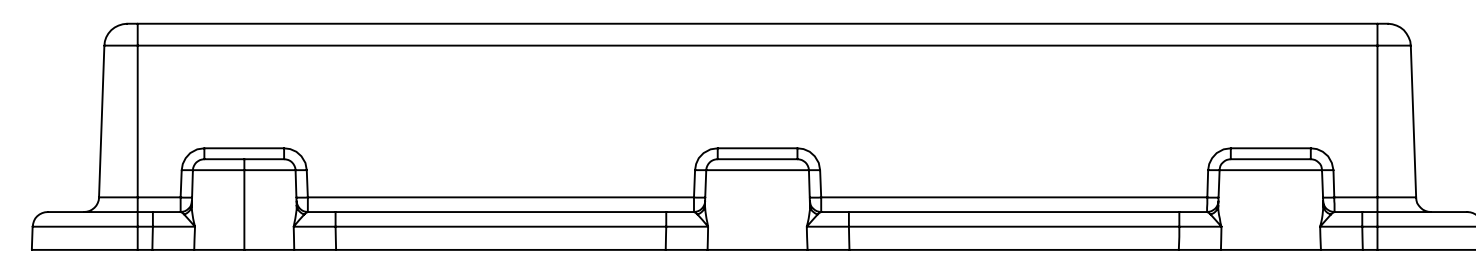

SURFACE-1

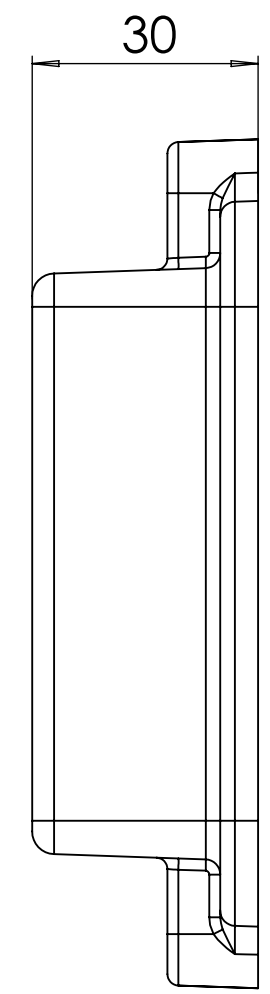

SURFACE-3

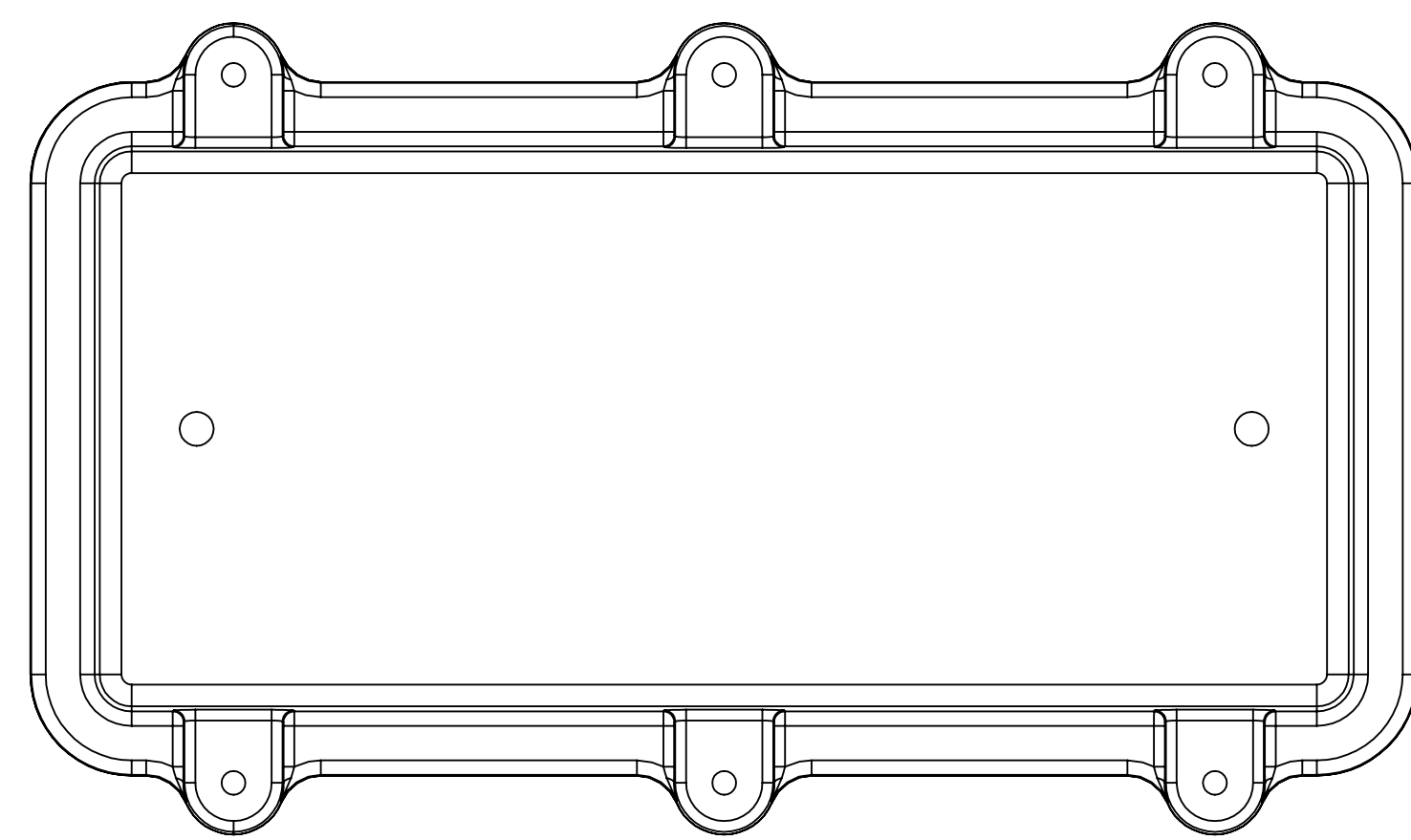

SURFACE-5

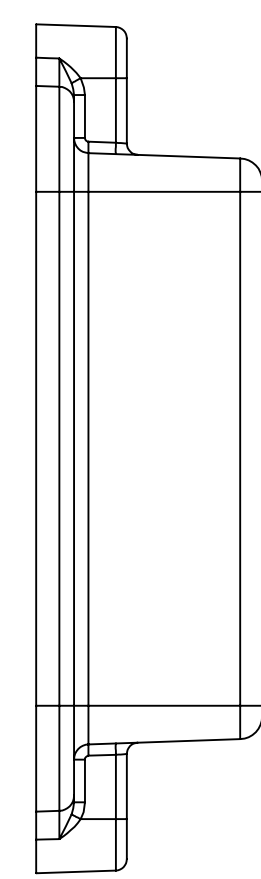

SURFACE-4

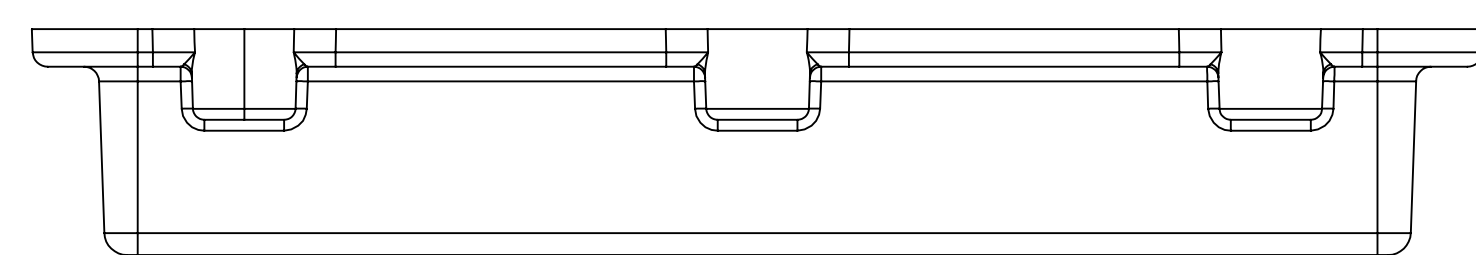

SURFACE-2

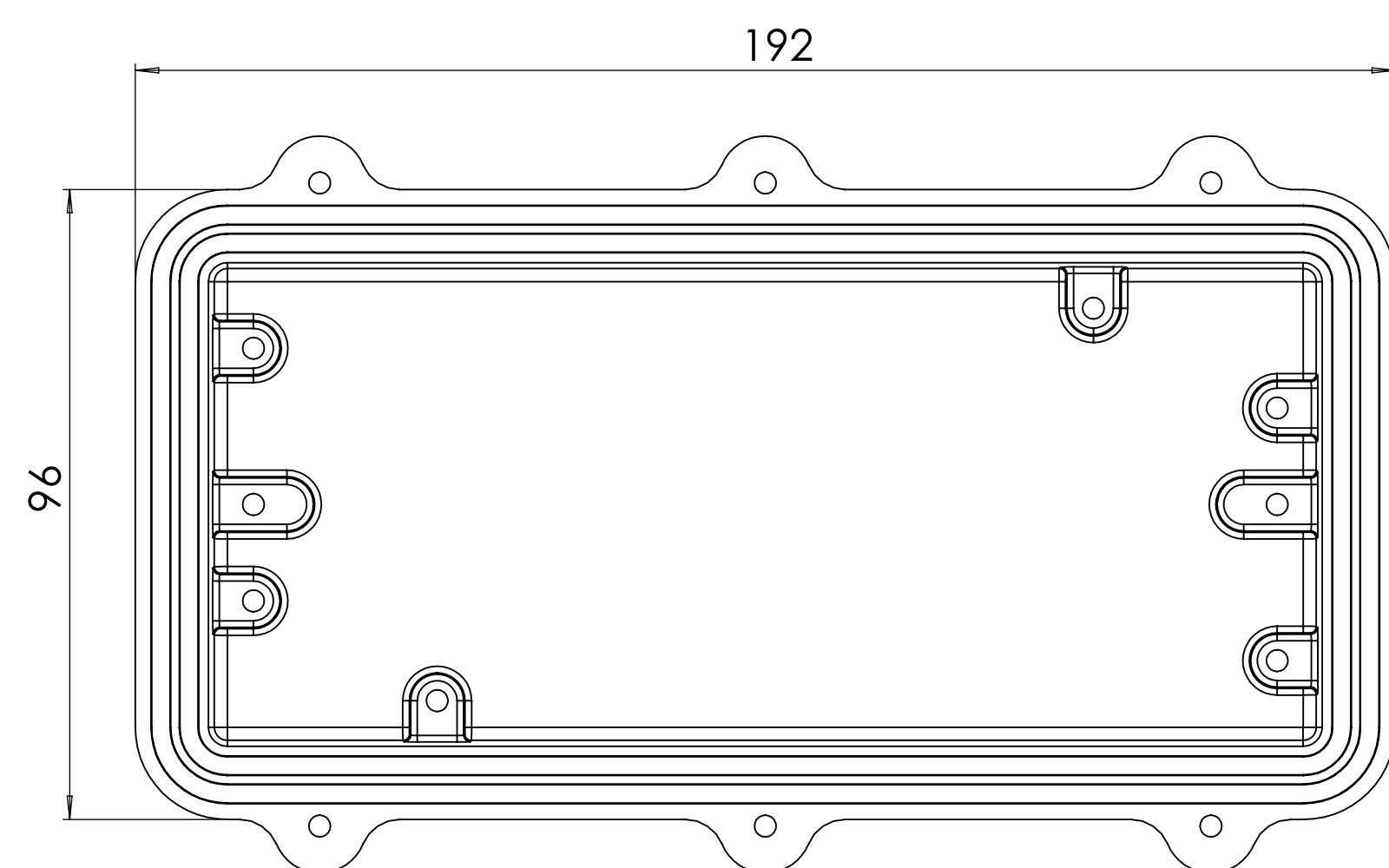

SURFACE-6 (INSIDE)

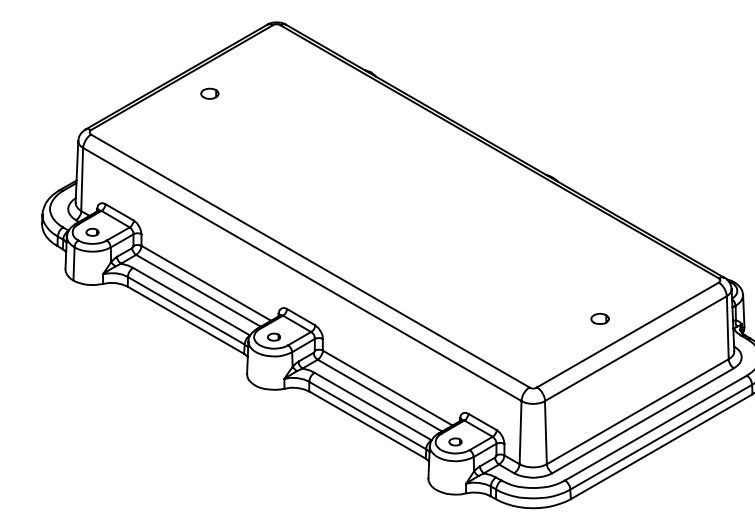

COVER: 6 SURFACE

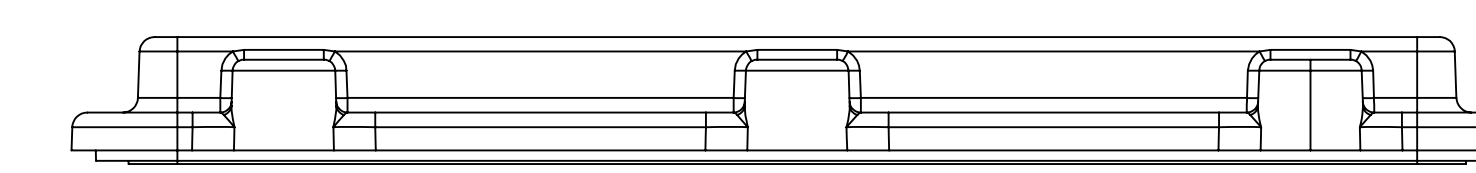

SURFACE-7

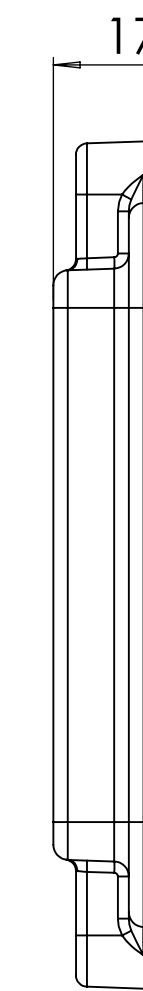

SURFACE-9

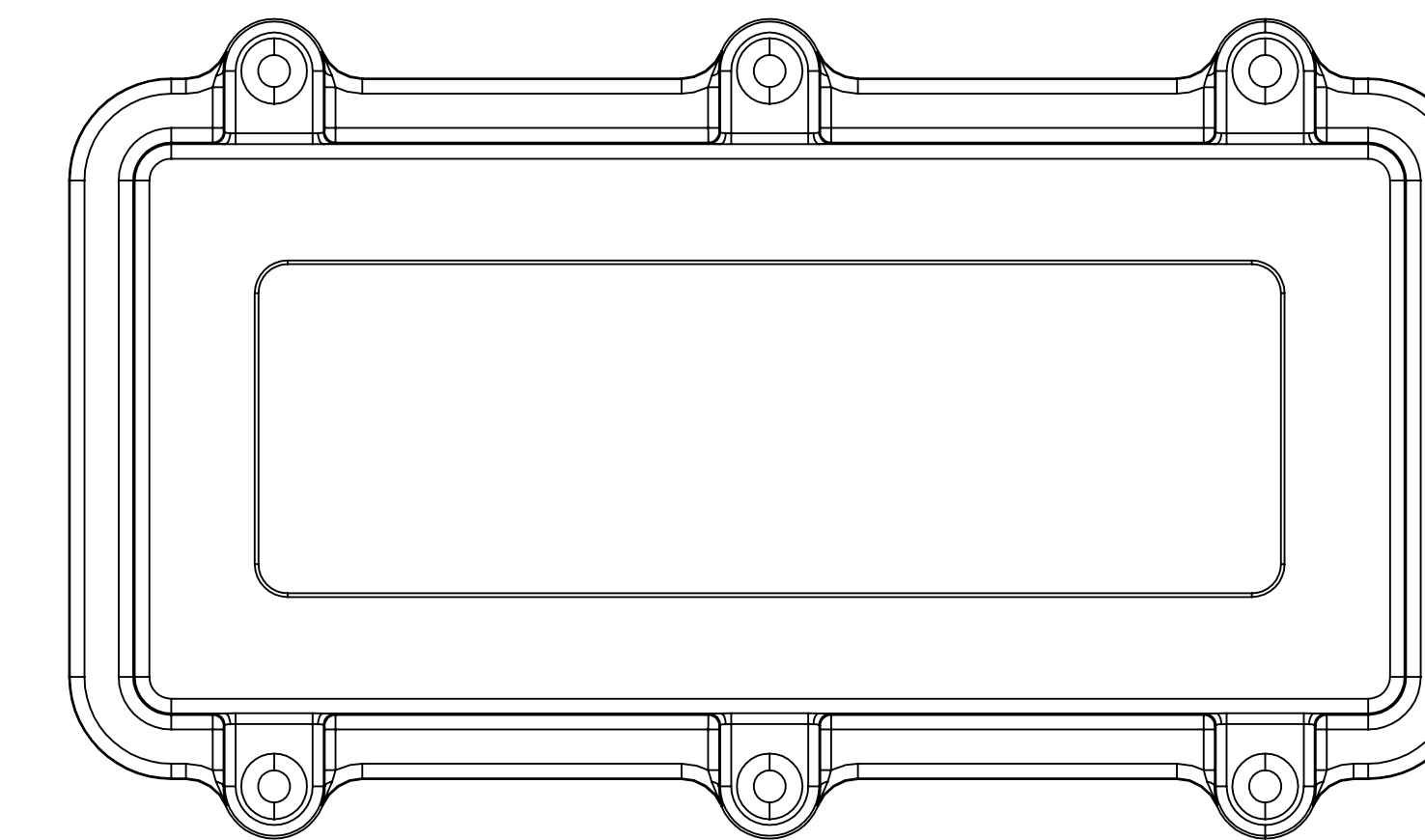

SURFACE-11

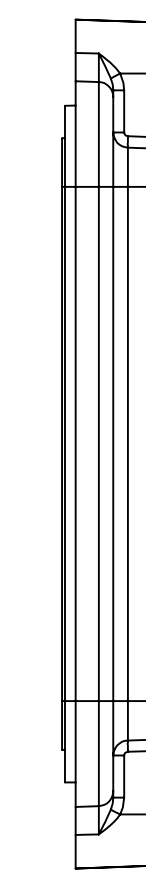

SURFACE-10

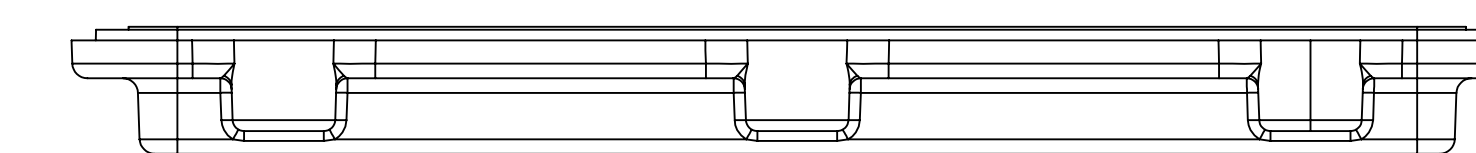

SURFACE-8

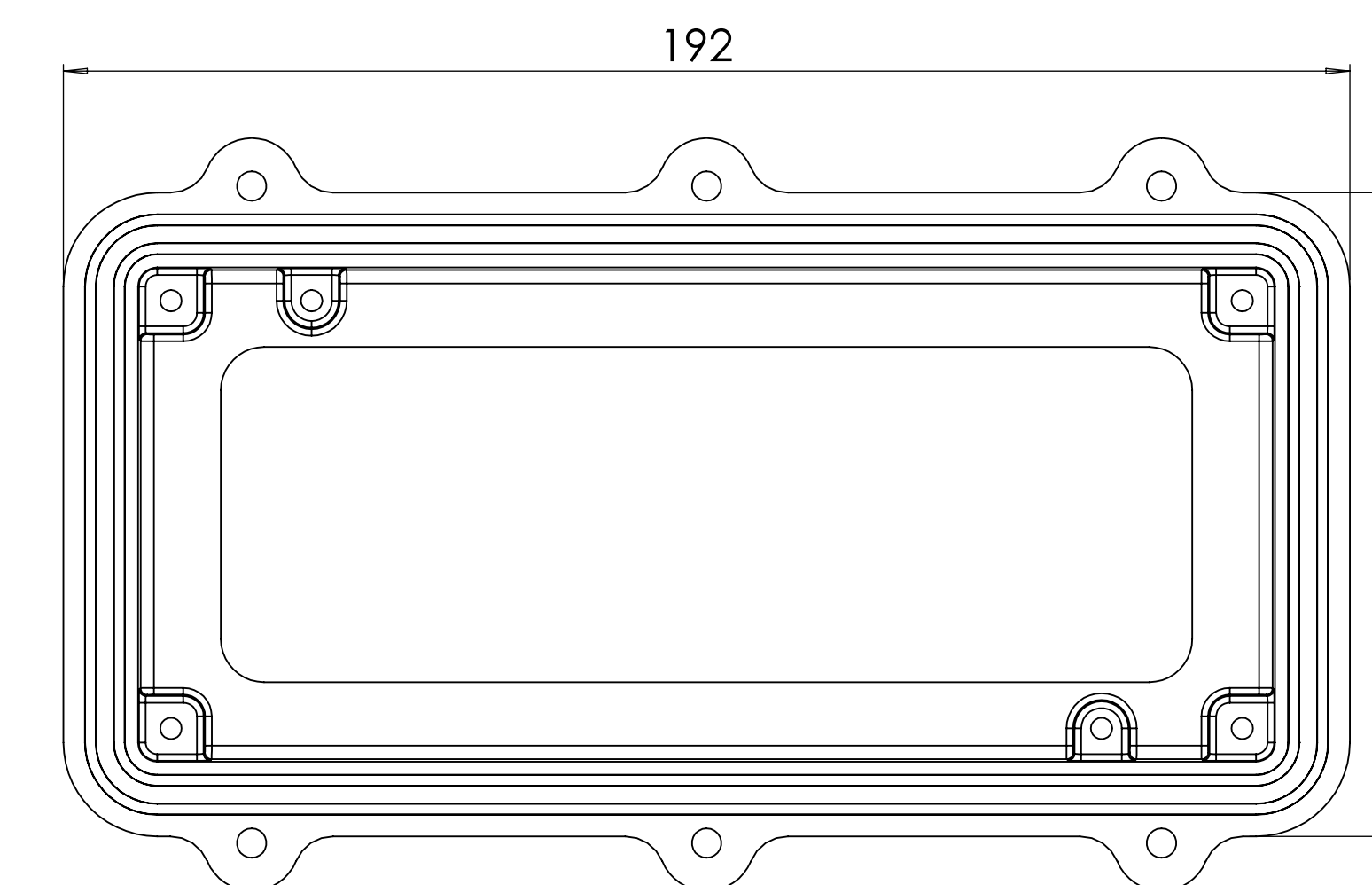

SURFACE-12 (INSIDE)

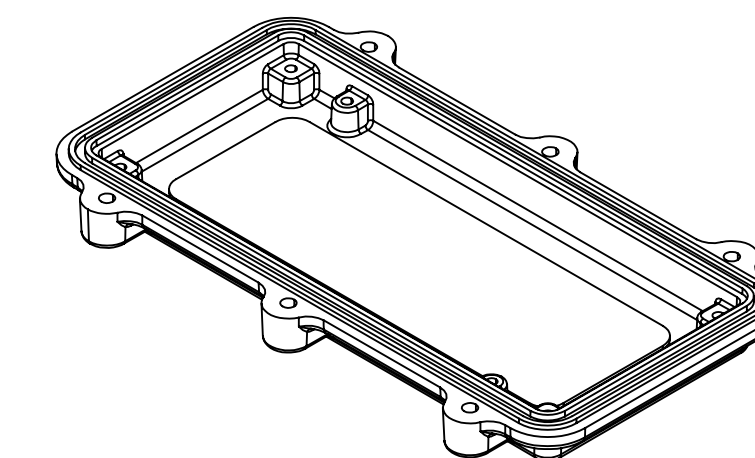

REV. NO	DATE	REVISED BY	DESCRIPTION OF CHANGE
 ALTINKAYA Electronic Enclosures & Components			
Customer Name:		Customer Ref.:	
Altinkaya Ref.:		Part Name: SE-526	
DRAWN	NAME	DATE	Drawn From:
CHECKED	Y.YEL	18.11.2024	Weight:
DIMENSIONAL TOLERANCES UNLESS OTHERWISE SPECIFIED (DIN7168)			
0.5-3mm	3-6mm	6-30mm	30-120mm
±0.1	±0.1	±0.2	±0.3
120-400mm Dimension (mm) ±0.5 m (Medium)			
SCALE 1:1			SHEET 01 OF 2
UNIT: mm			A0

www.altinkaya.com

SE-526 IF MACHINED TOGETHER

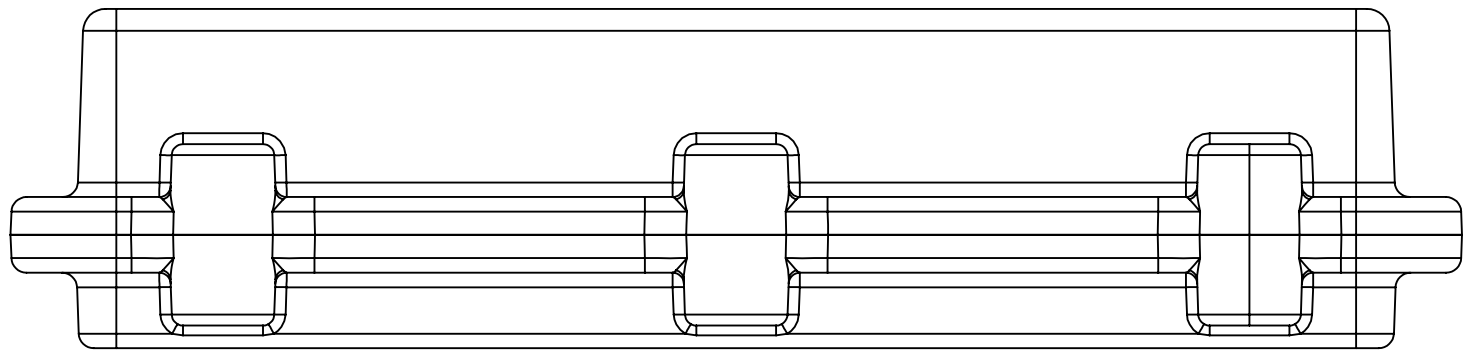

SURFACE-13

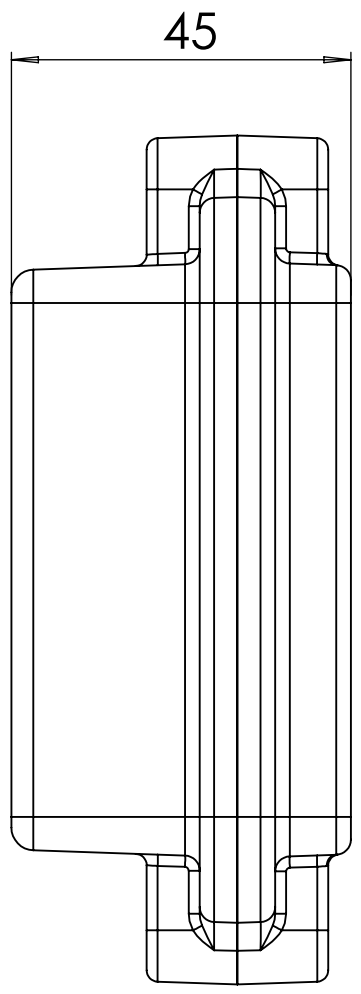

SURFACE-15

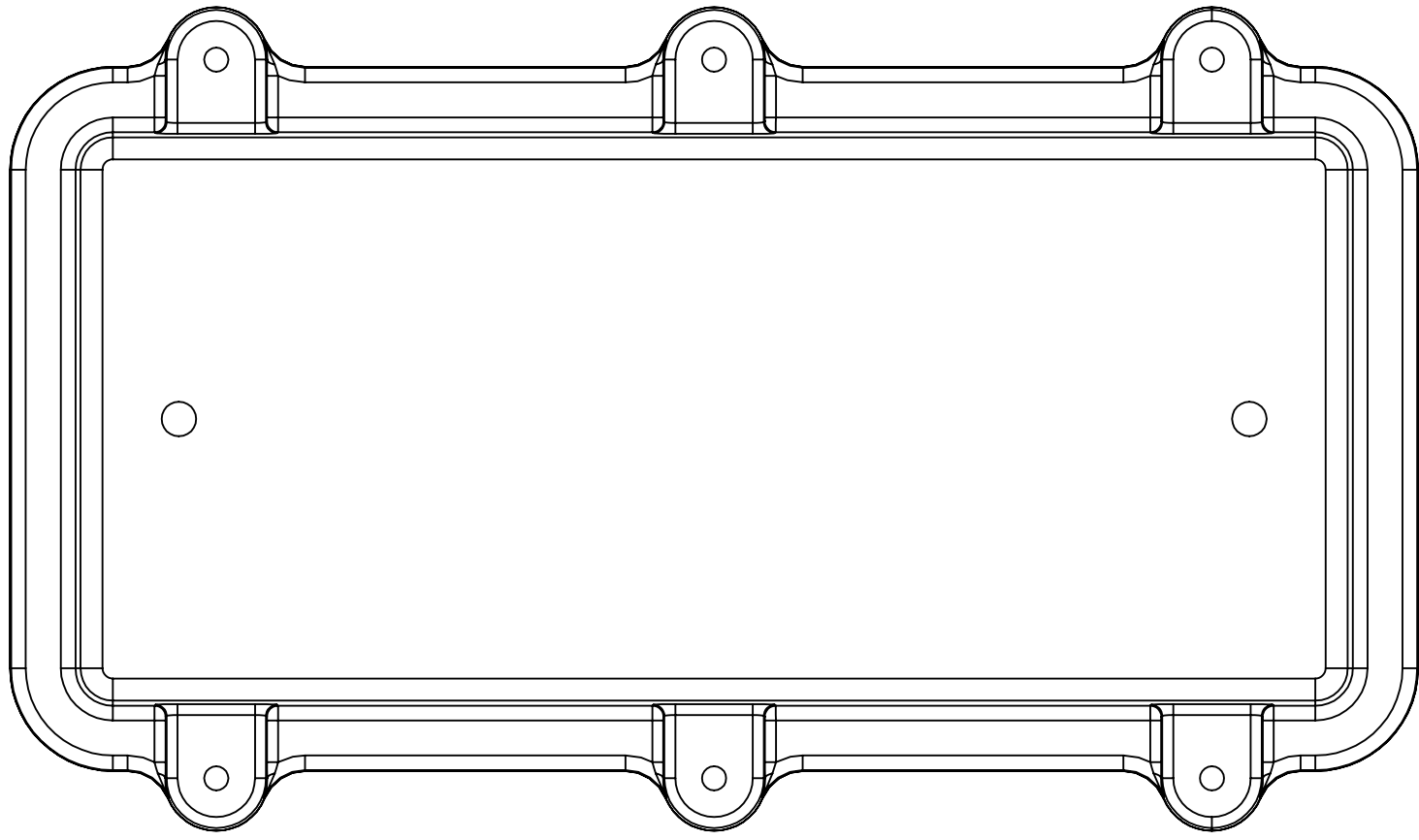

SURFACE-17

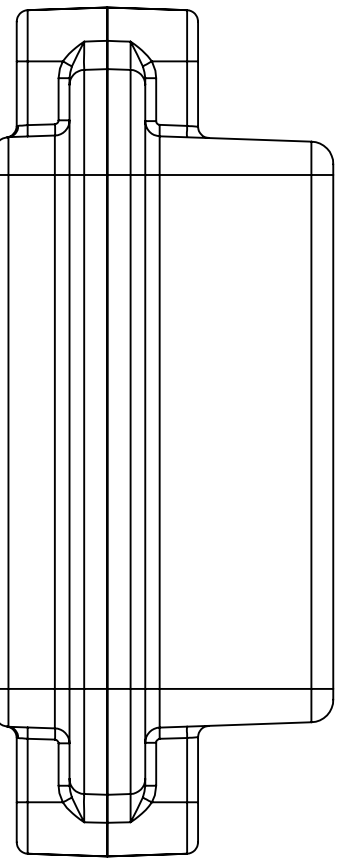

SURFACE-16

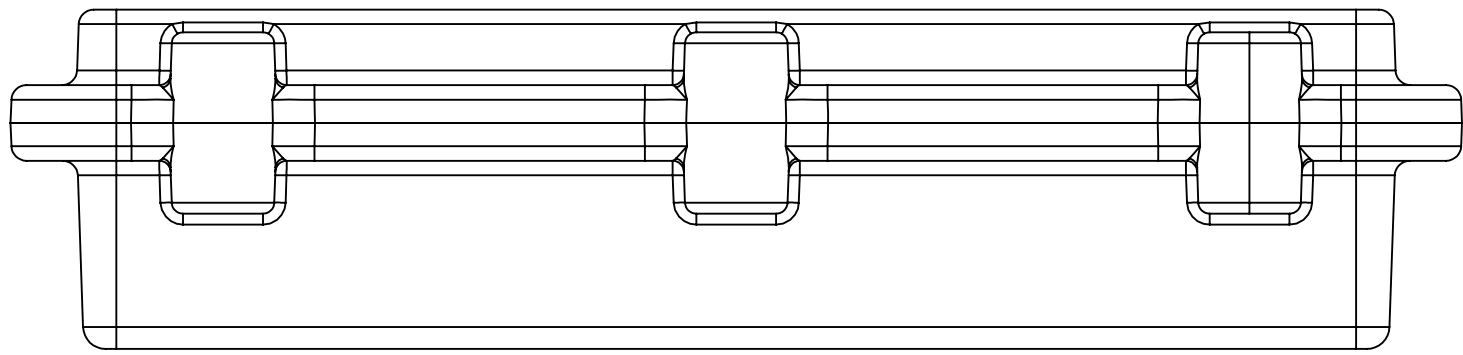

SURFACE-14

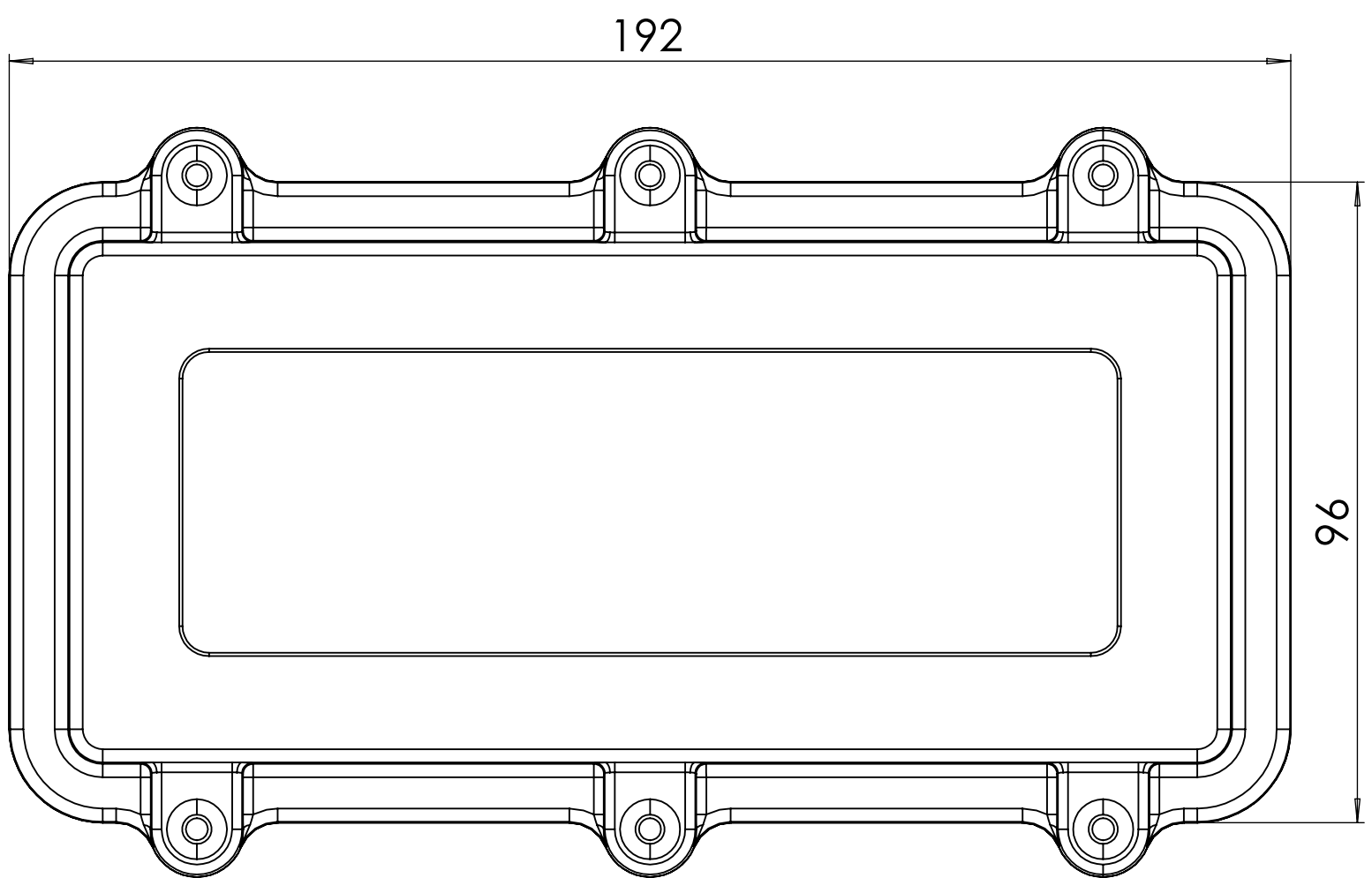

SURFACE-18

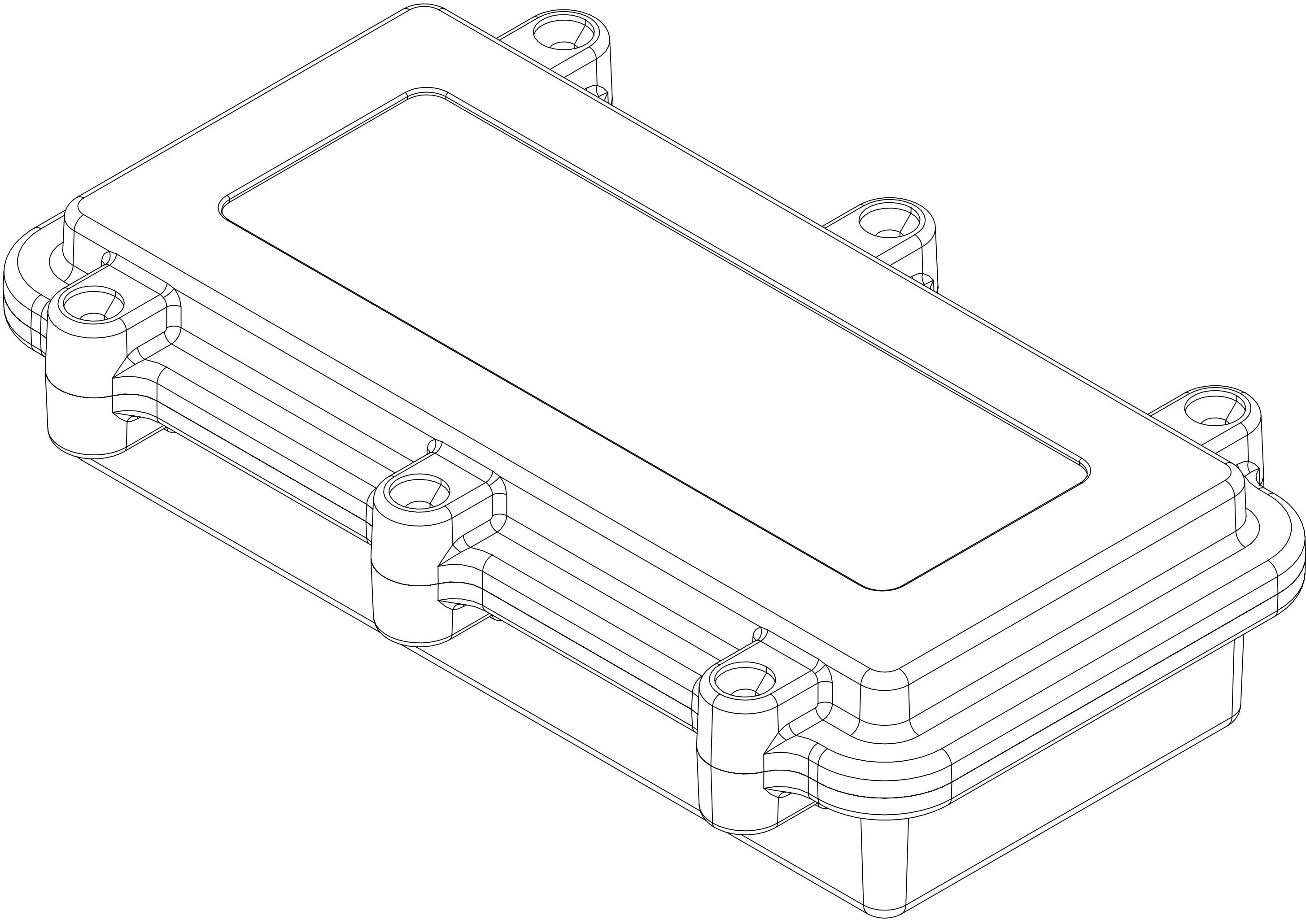
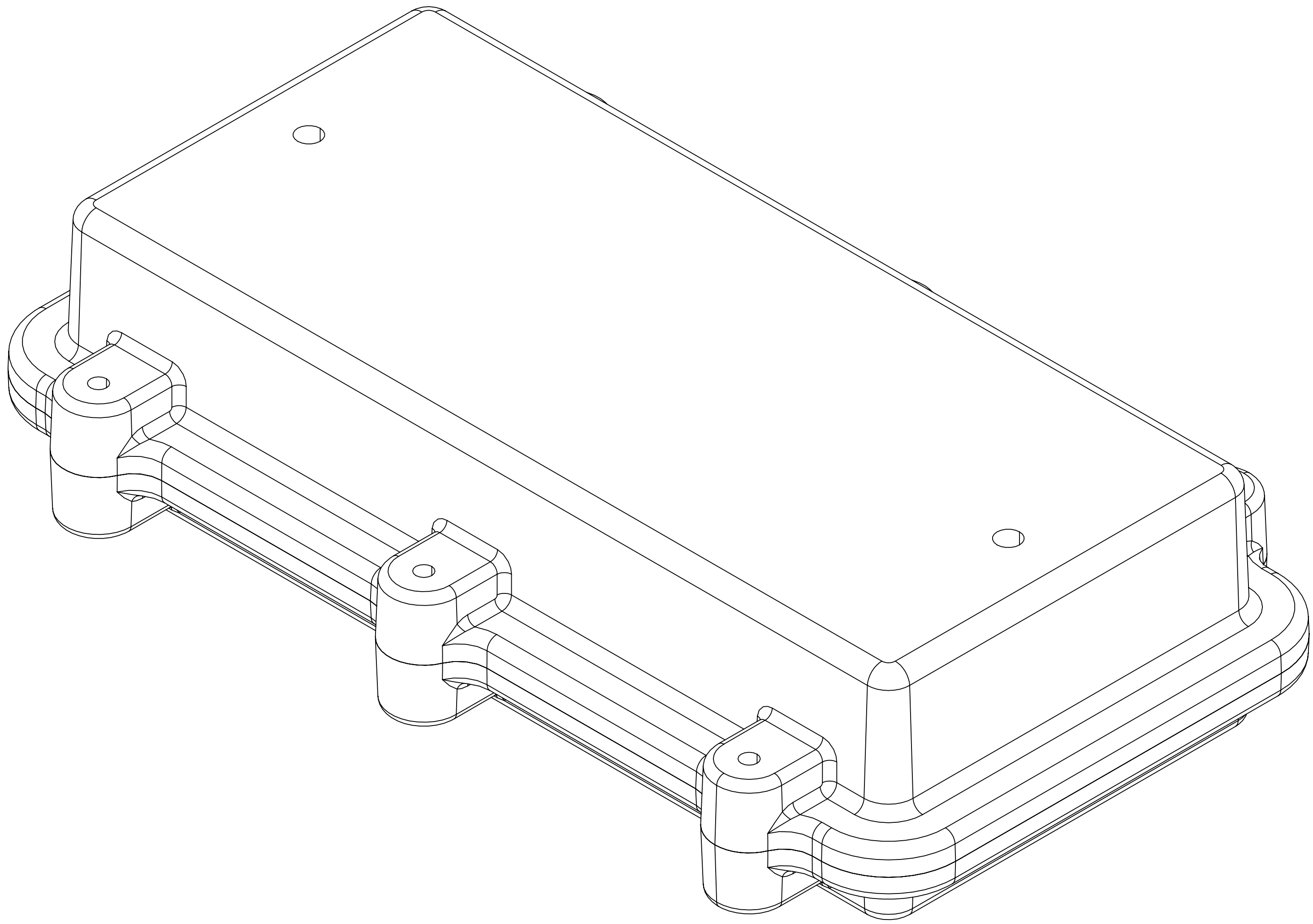

REV. NO	DATE	REVISED BY	DESCRIPTION OF CHANGE
 ALTINKAYA Electronic Enclosures & Components			www.altinkaya.com
Customer Name:		Customer Ref.:	
Altinkaya Ref.:		Part Name: SE-526	
DRAWN	NAME	DATE	Drawn From:
CHECKED	Y.YEL	18.11.2024	Weight:
DIMENSIONAL TOLERANCES UNLESS OTHERWISE SPECIFIED (DIN7168)			
0.5-3mm	3-6mm	6-30mm	30-120mm
±0.1	±0.1	±0.2	±0.3
			120-400mm
			±0.5
			m (Medium)
			SCALE 1:1
			SHEET 2 OF 2
			UNIT: mm
			A0