

**BASE: 6 SURFACE**

**COVER: 6 SURFACE**

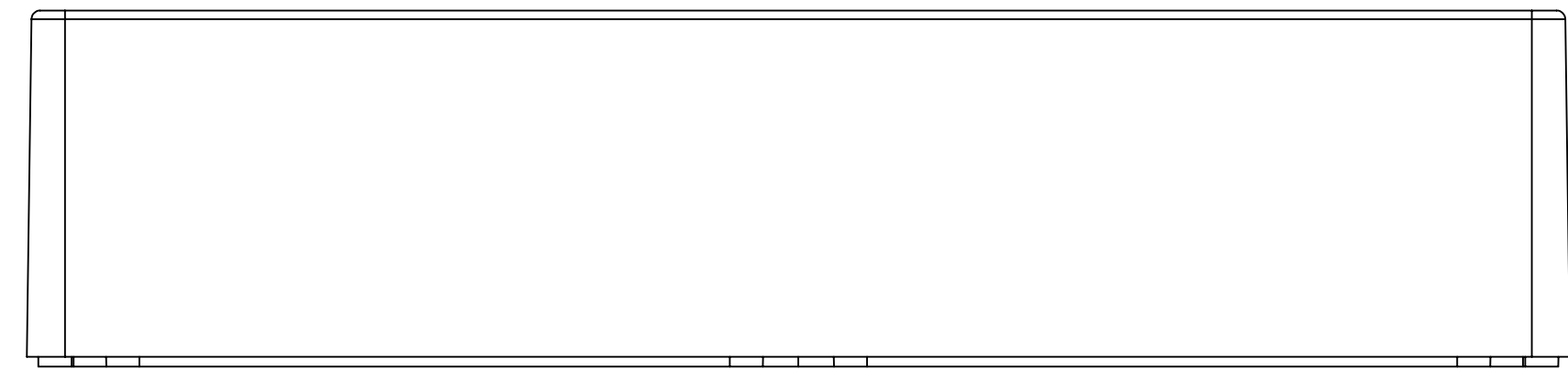

SURFACE-1

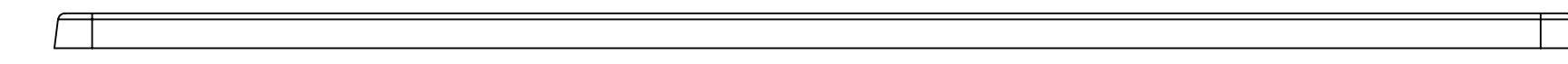

SURFACE-7

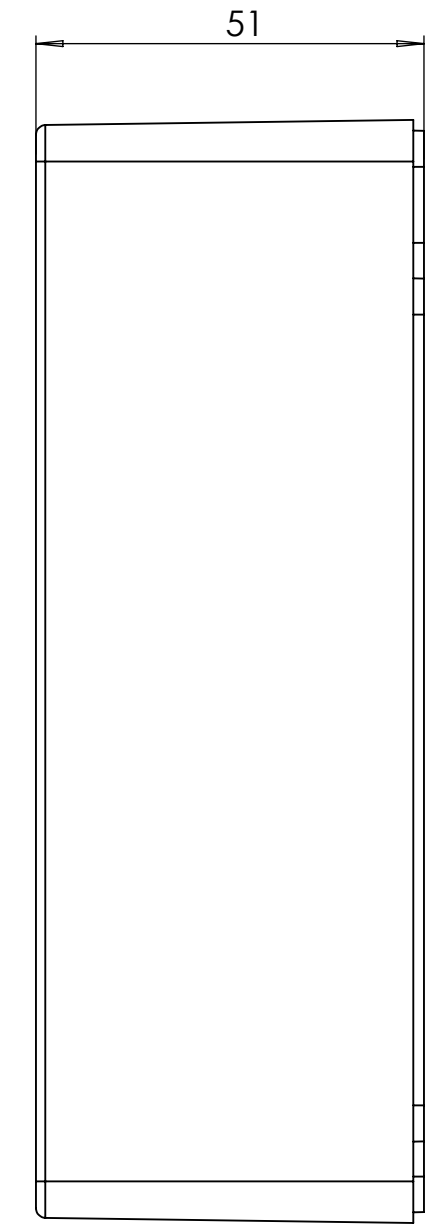

SURFACE-3

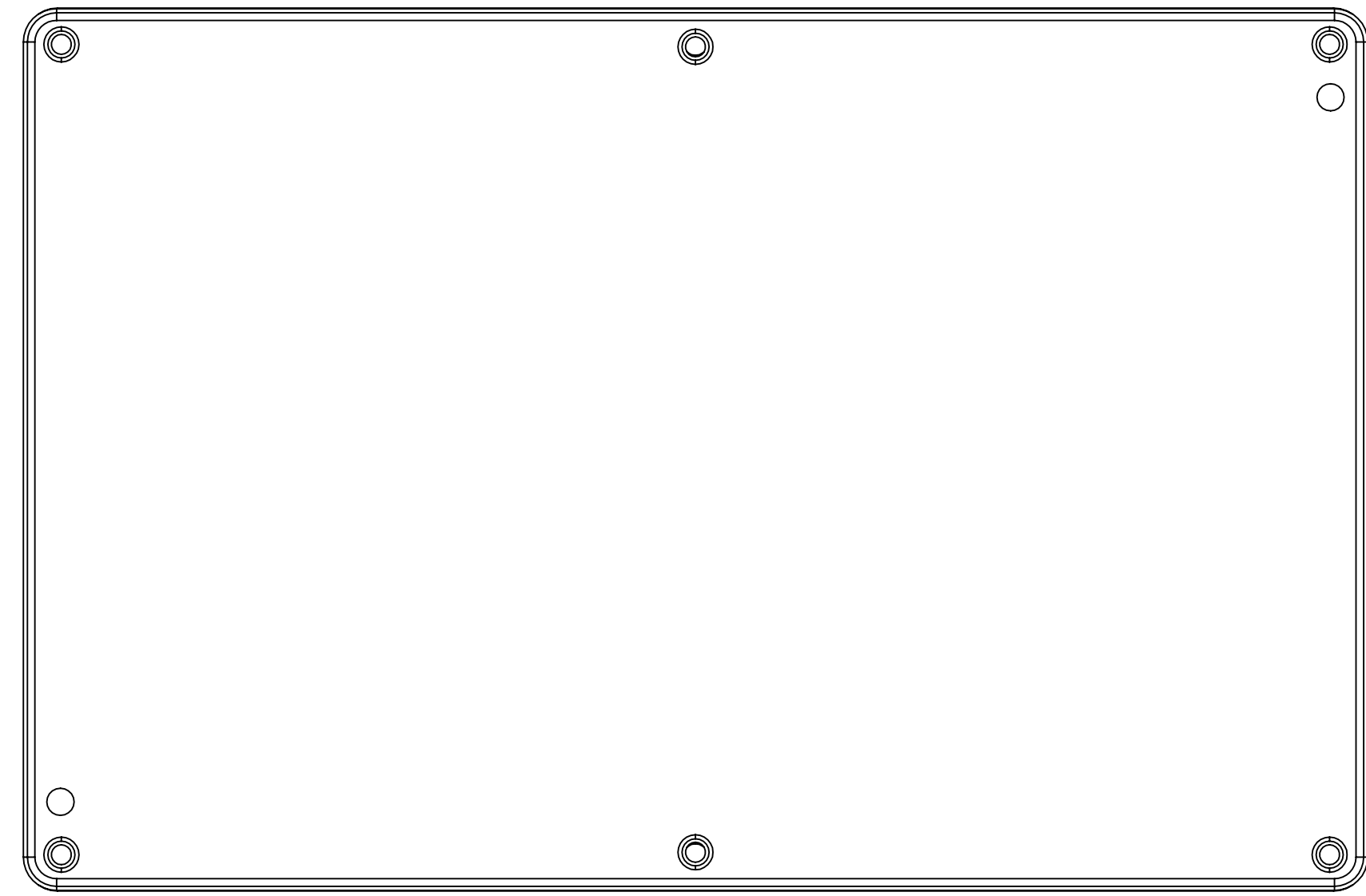

SURFACE-5

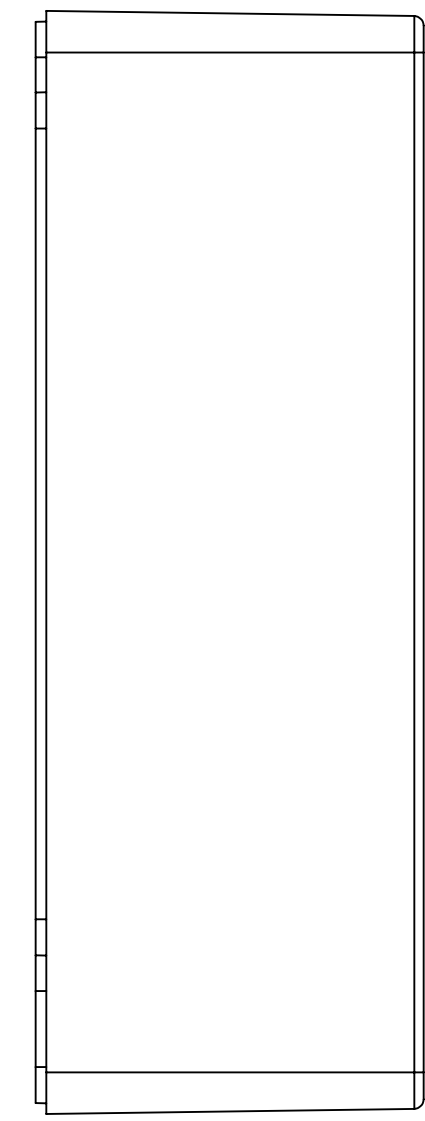

SURFACE-4

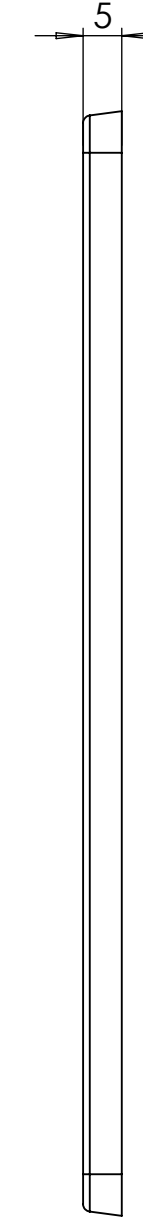

SURFACE-9

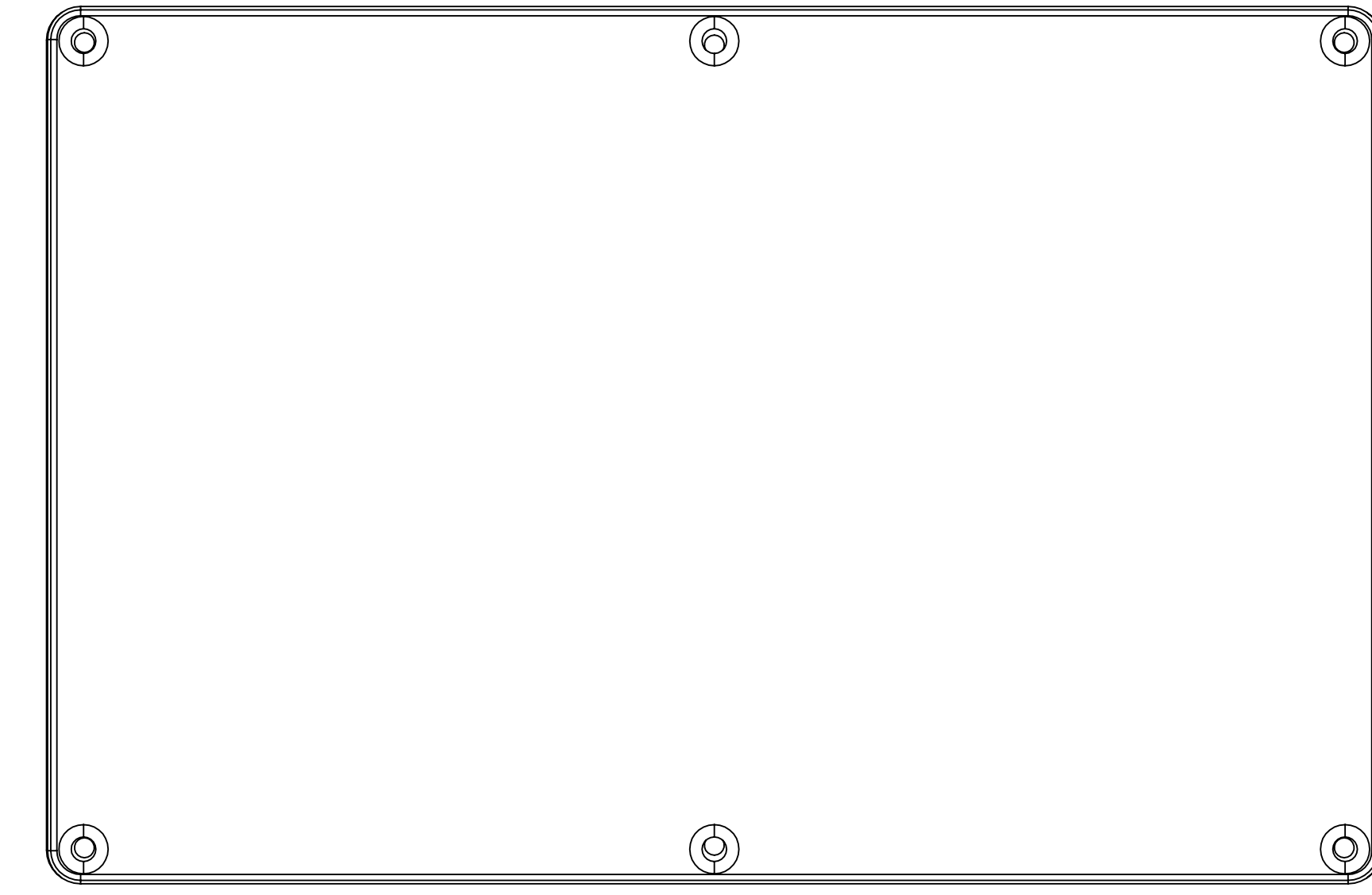

SURFACE-11

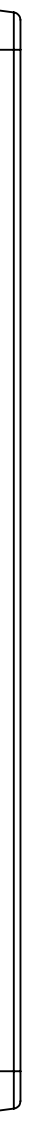

SURFACE-10

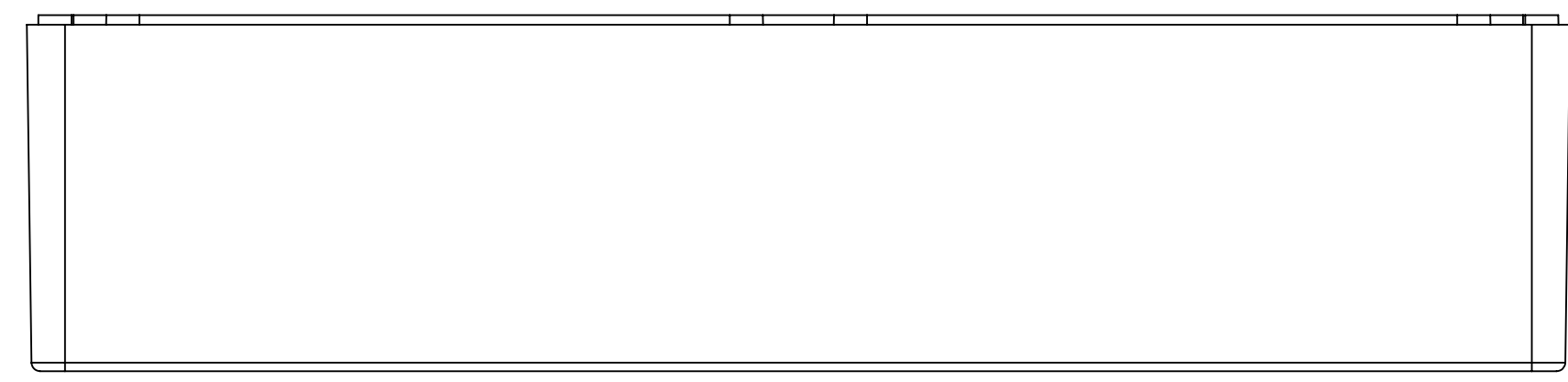

SURFACE-2

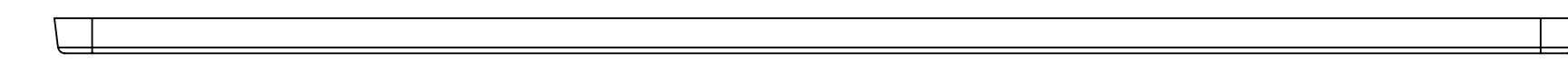

SURFACE-8

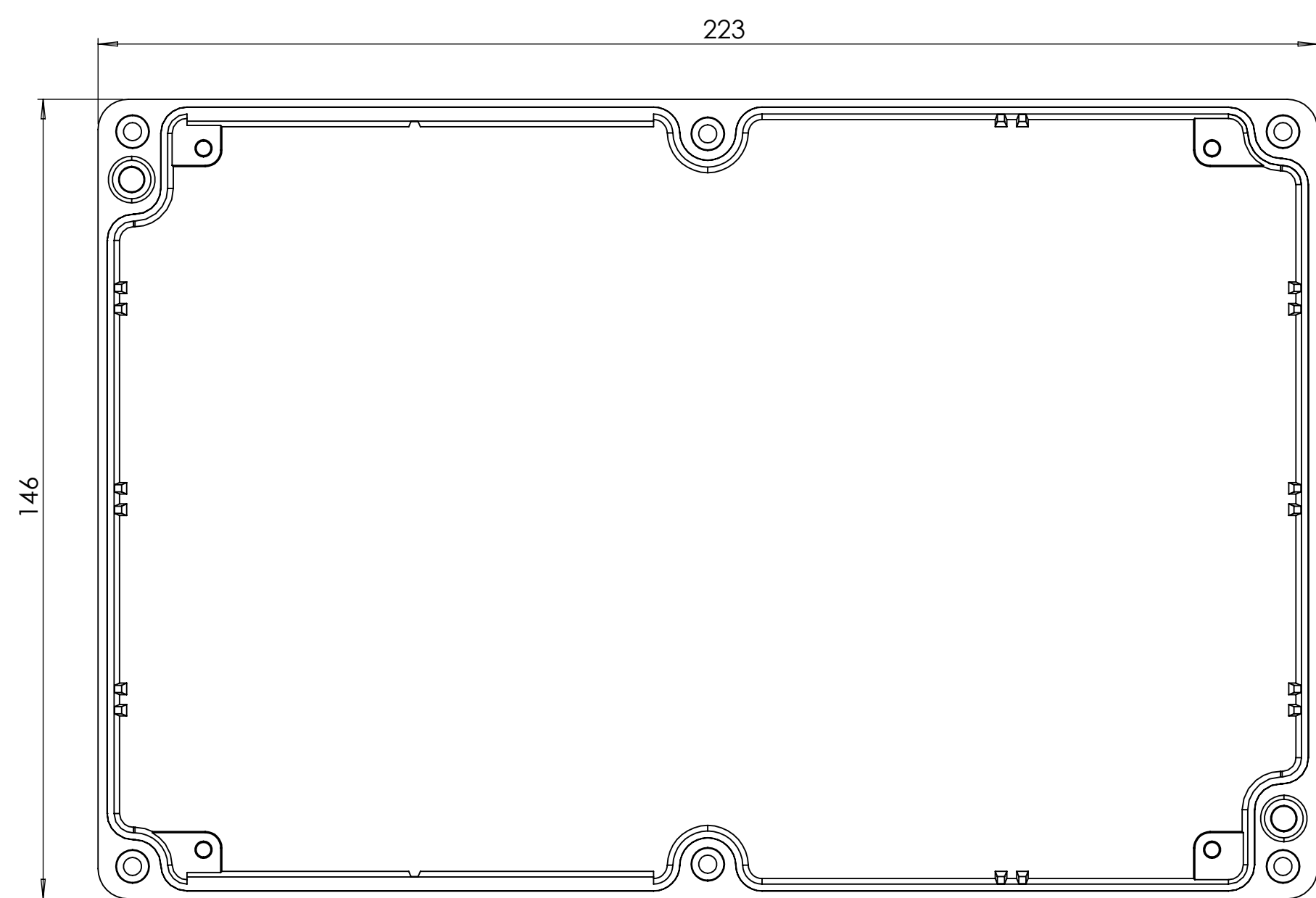

SURFACE-6 (INSIDE)

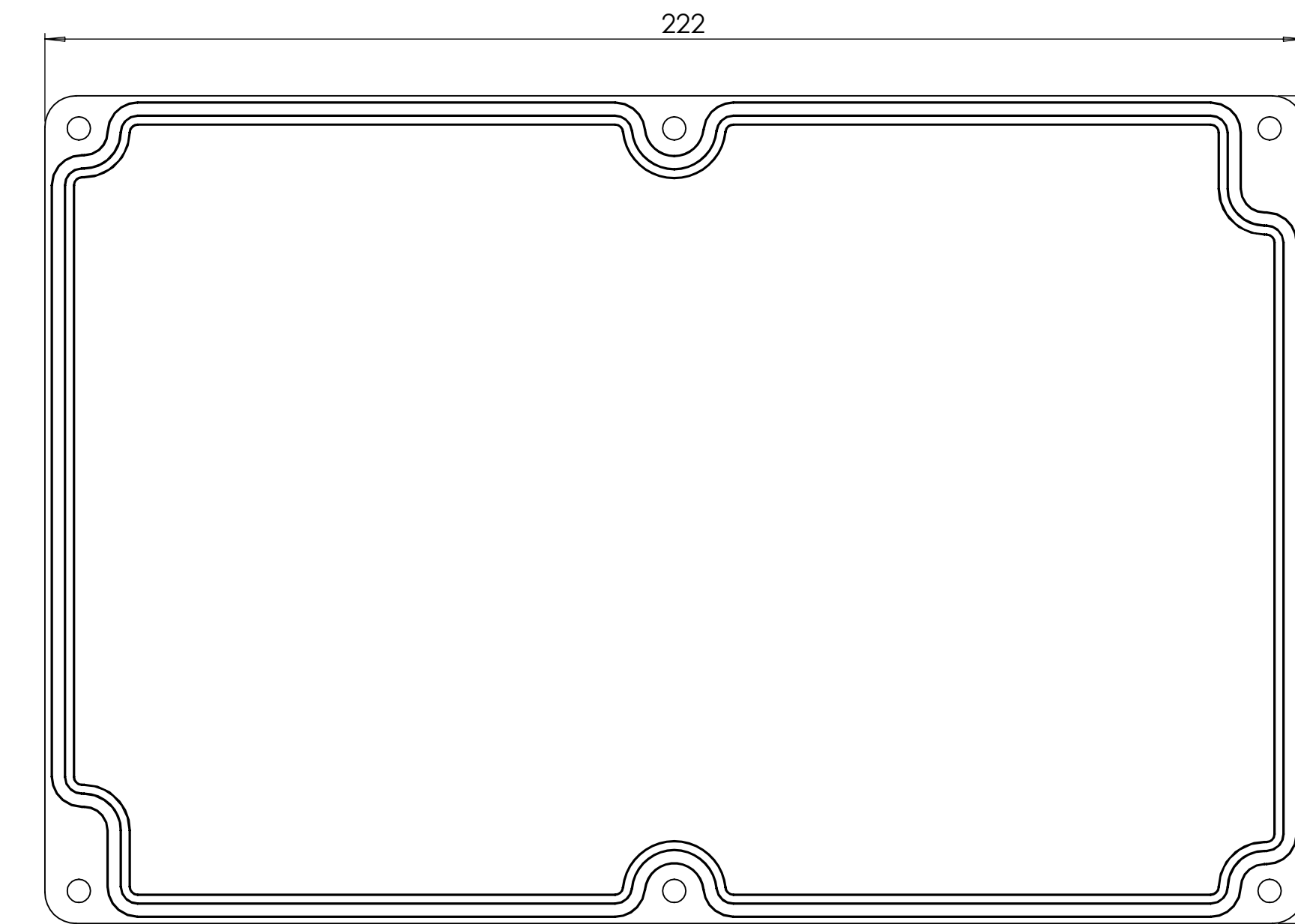
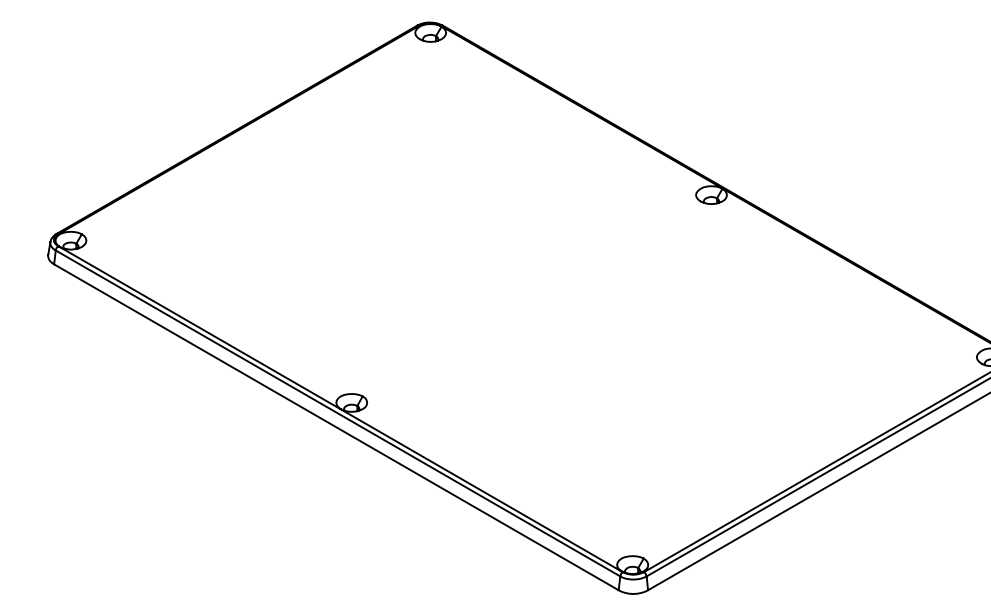
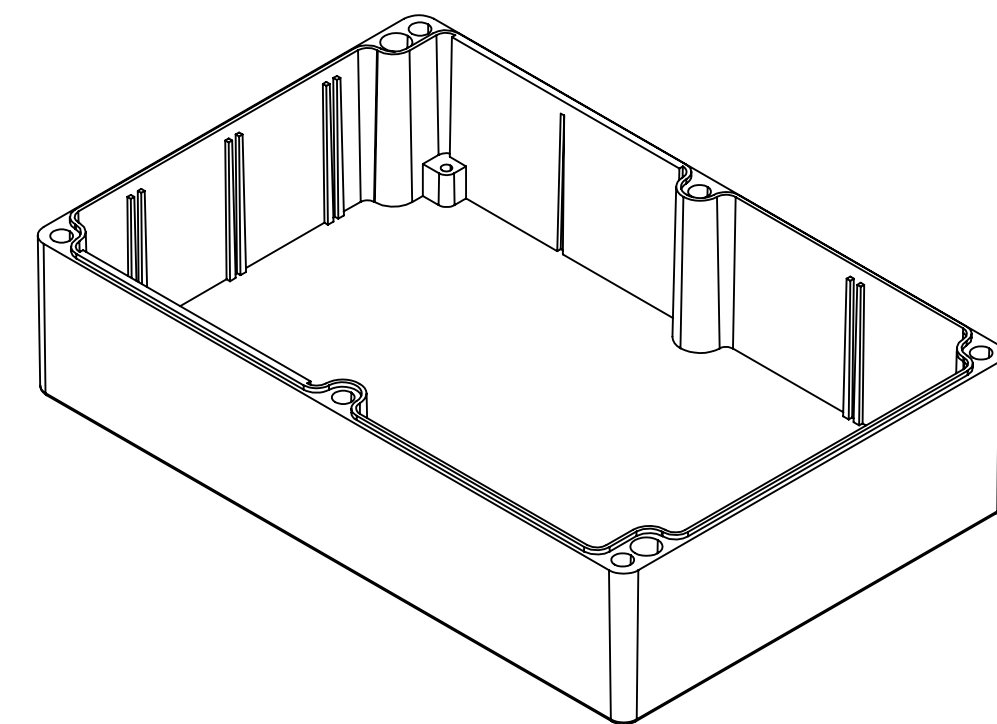

SURFACE-12 (INSIDE)

REV. NO	DATE	REVISED BY	DESCRIPTION OF CHANGE
 <b>ALTINKAYA</b> Electronic Enclosures & Components			
Customer Name:		Customer Ref.:	
Altinkaya Ref.:		Part Name: SE-333-0-0	
DRAWN	NAME	DATE	Drawn From:
CHECKED	Y.YEL	26.11.2024	Material:
DIMENSIONAL TOLERANCES UNLESS OTHERWISE SPECIFIED (DIN7168)			SCALE 1:1 SHEET 1 OF 2
0.5-3mm	3-6mm	6-30mm	30-120mm
±0.1	±0.1	±0.2	±0.3
UNITS: mm			Dimension (mm)
			±0.5
			m (Medium)
			A0

www.altinkaya.com

Part Name: SE-333-0-0

Drawn From:

Material:

Weight:

UNITS: mm

Dimension (mm)

±0.5

m (Medium)

A0

