

**BASE: 6 SURFACE**

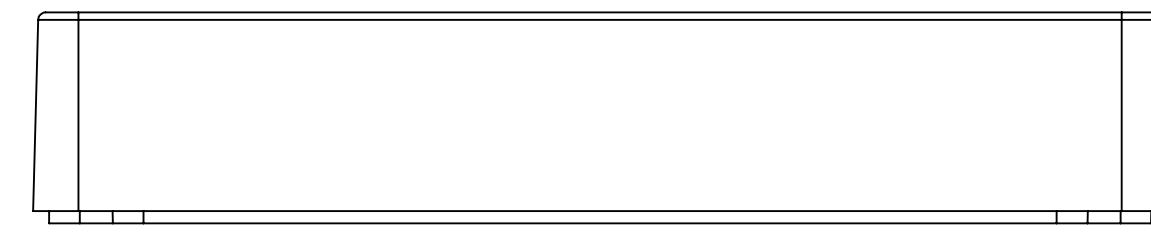

SURFACE-1

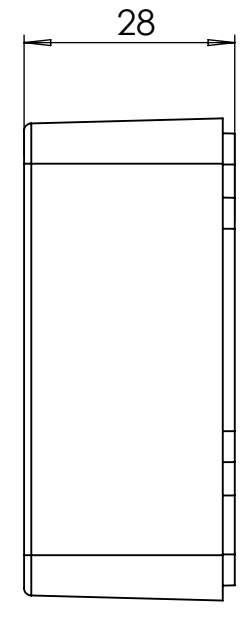

SURFACE-3

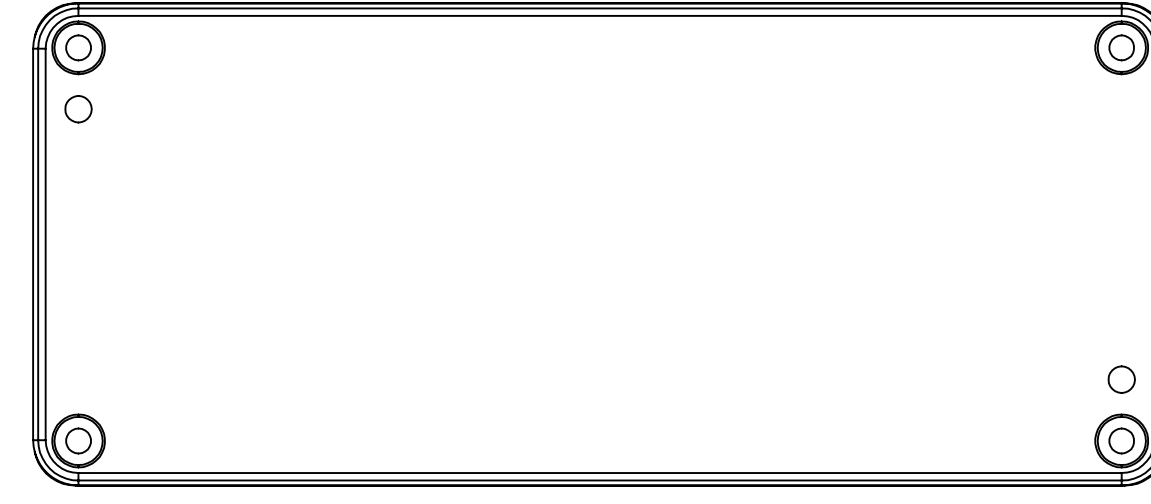

SURFACE-5

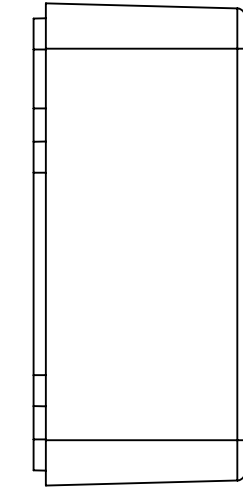

SURFACE-4

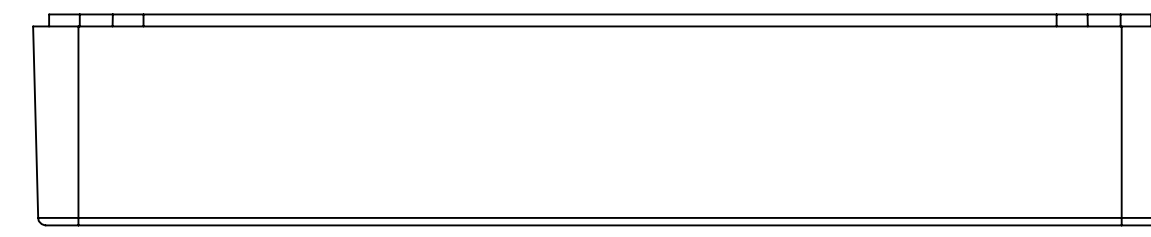

SURFACE-2

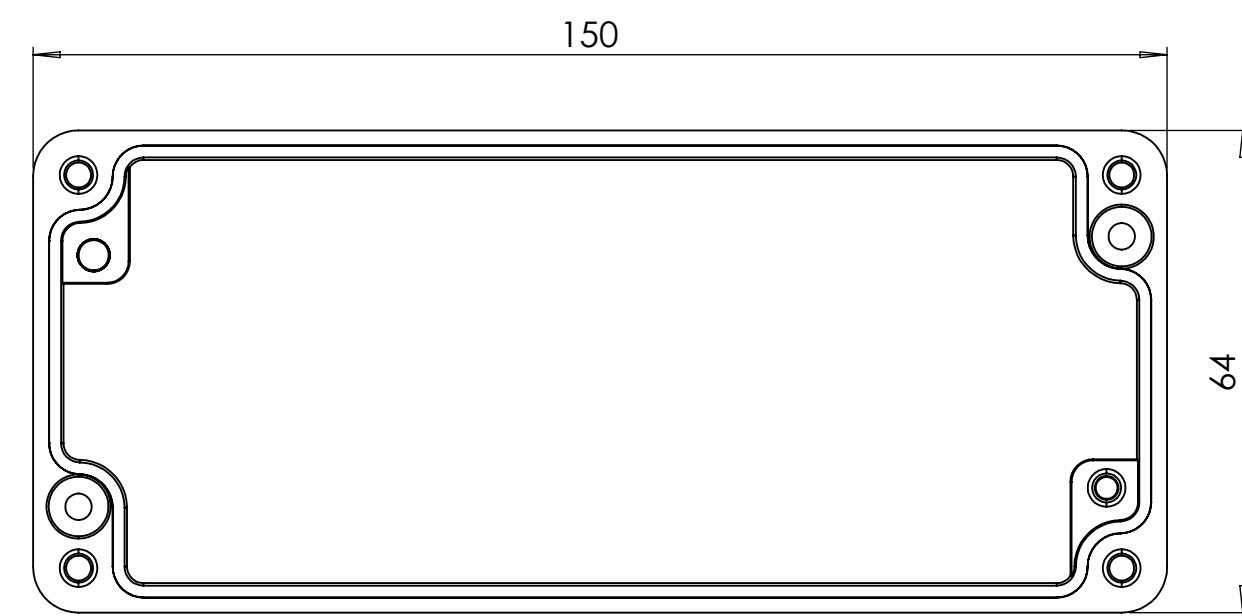

SURFACE-6 (INSIDE)

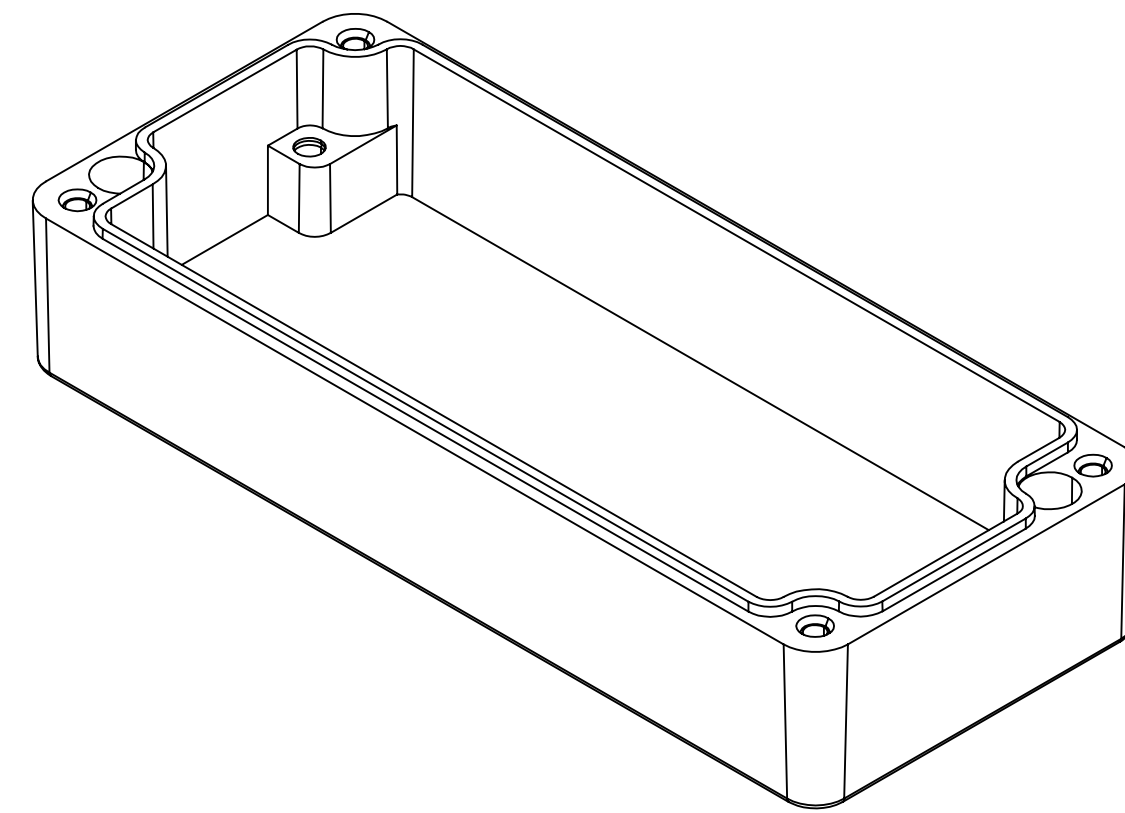

**COVER: 6 SURFACE**

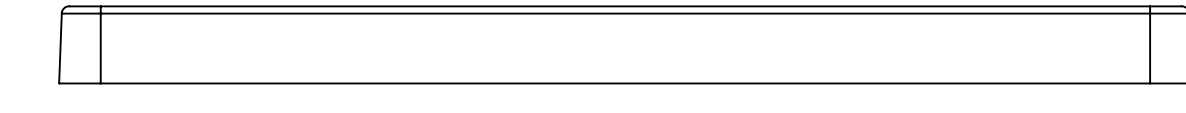

SURFACE-7

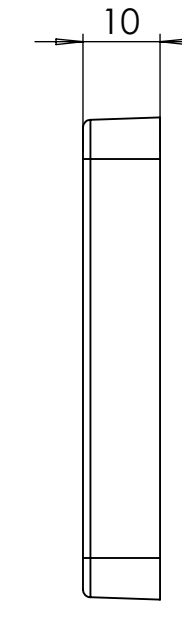

SURFACE-9

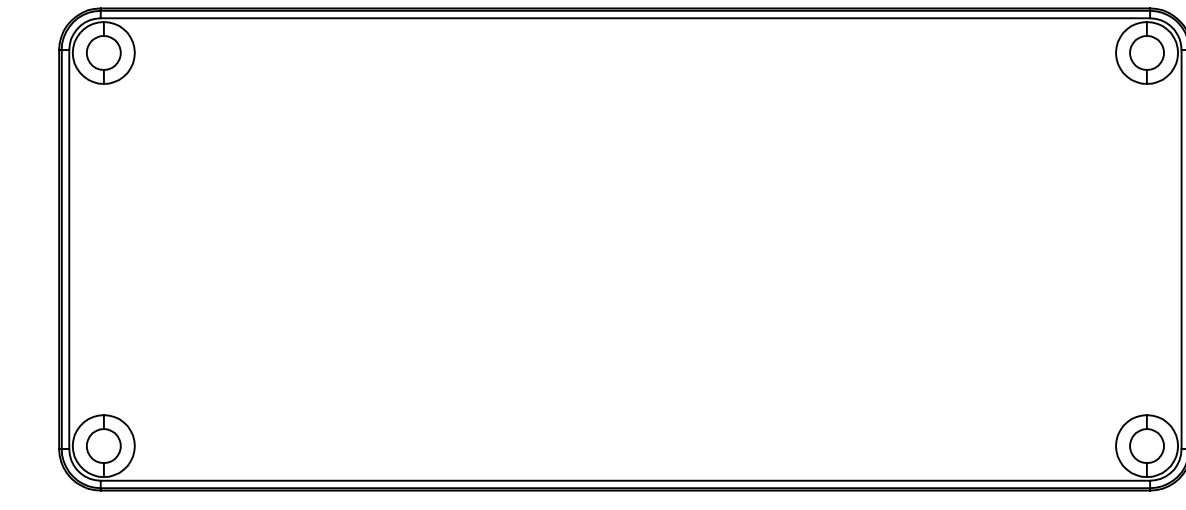

SURFACE-11

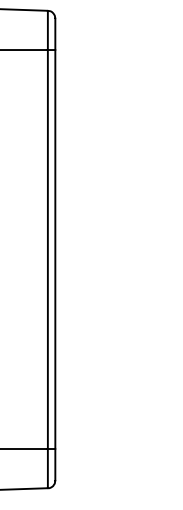

SURFACE-10

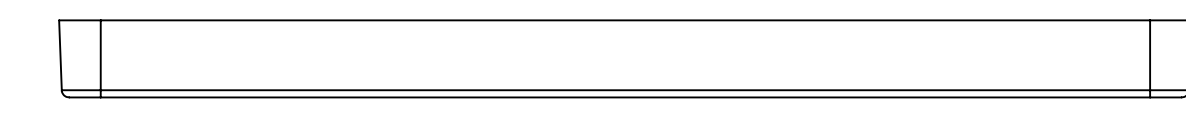

SURFACE-8

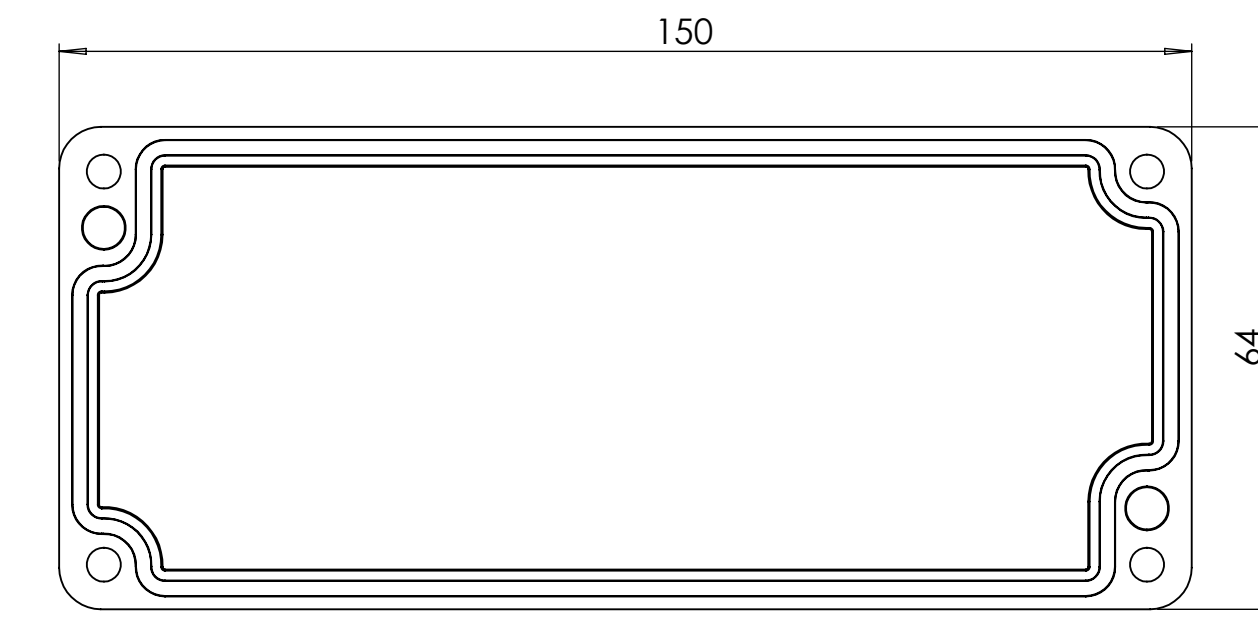

SURFACE-12 (INSIDE)

| REV. NO  | DATE  | REVISED BY            | DESCRIPTION OF CHANGE      |
|--|-------|-----------------------|----------------------------|
|  <b>ALTINKAYA</b><br>Electronic Enclosures & Components |       |                       |                            |
| Customer Name:   |       | Customer Ref.:        |                            |
| Altinkaya Ref.:  |       | Part Name: SE-313-0-0 |                            |
| DRAWN  | NAME  | DATE                  | Drawn From:                |
| CHECKED  | Y.YEL | 25.11.2024            | Material:                  |
| DIMENSIONAL TOLERANCES UNLESS OTHERWISE SPECIFIED (DIN7168)  |       |                       | SCALE 1:1<br>SHEET 01 OF 2 |
| 0.5-3mm  | 3-6mm | 6-30mm                | 30-120mm                   |
| ±0.1   | ±0.1  | ±0.2                  | ±0.3                       |
| Weight:  |       |                       | 120-400mm                  |
|  |       |                       | ±0.5                       |
|  |       |                       | m (Medium)                 |
|  |       |                       | UNIT: mm                   |
|  |       |                       | A0                         |

**SE-313 IF MACHINED TOGETHER**

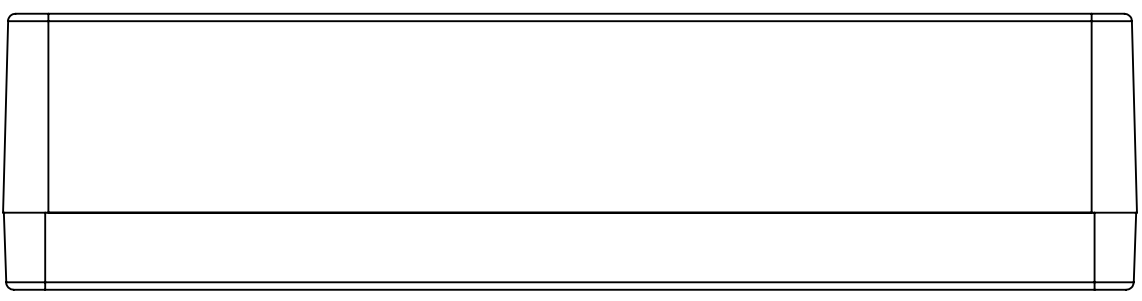

SURFACE-13

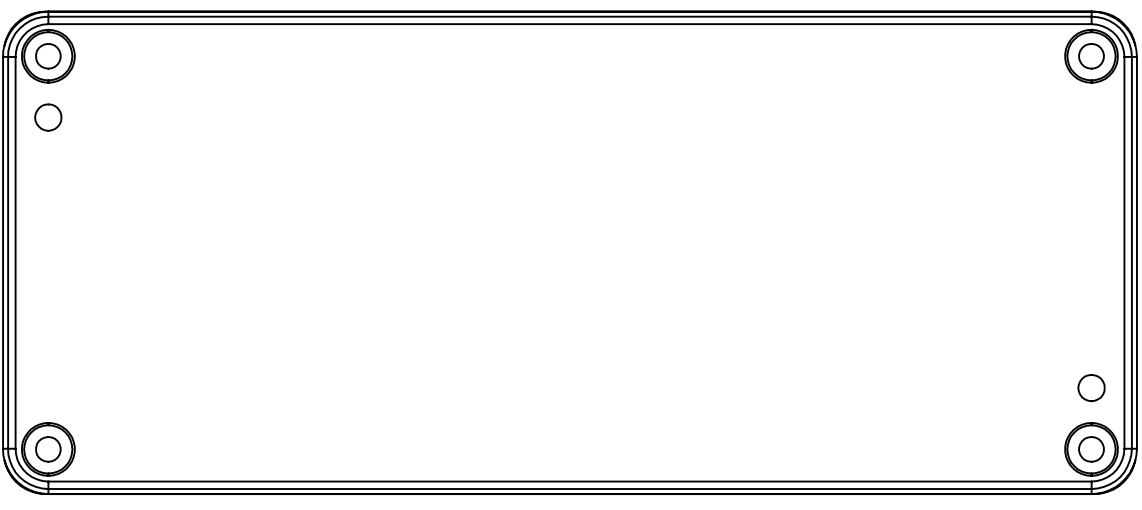

SURFACE-17

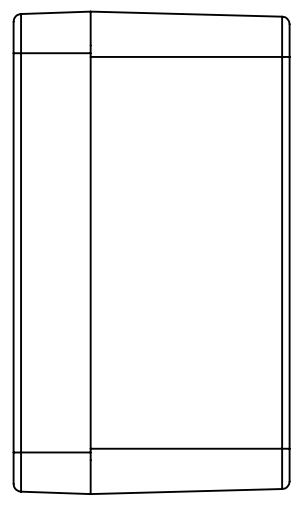

SURFACE-16

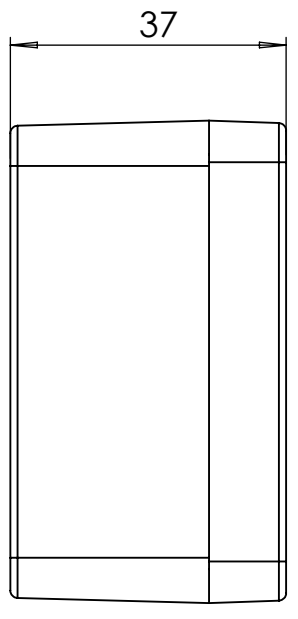

SURFACE-15

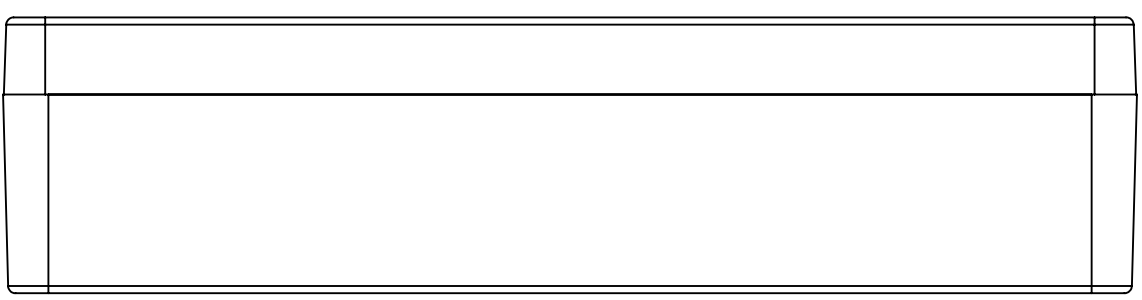

SURFACE-14

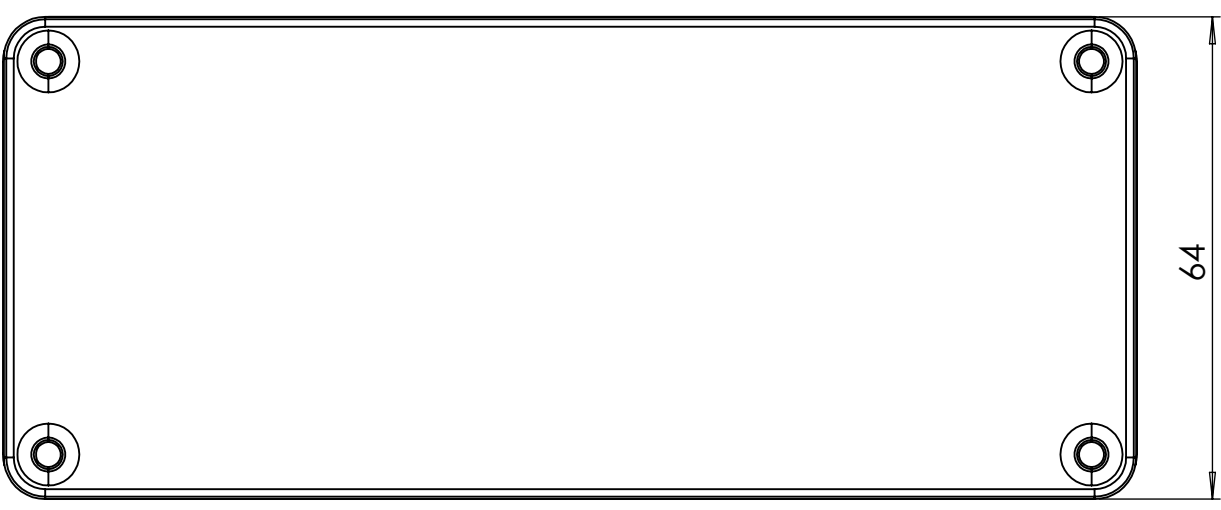

SURFACE-18

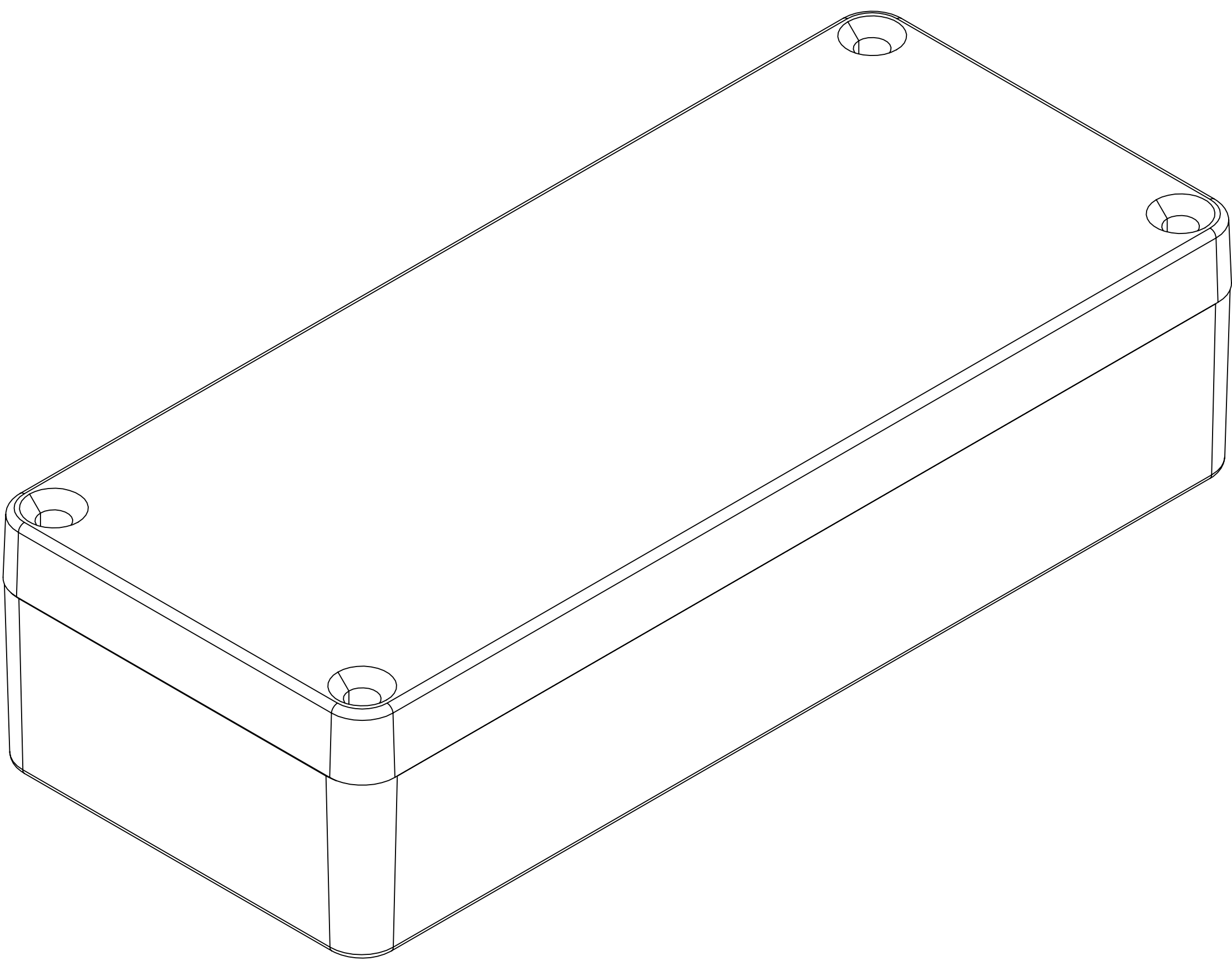
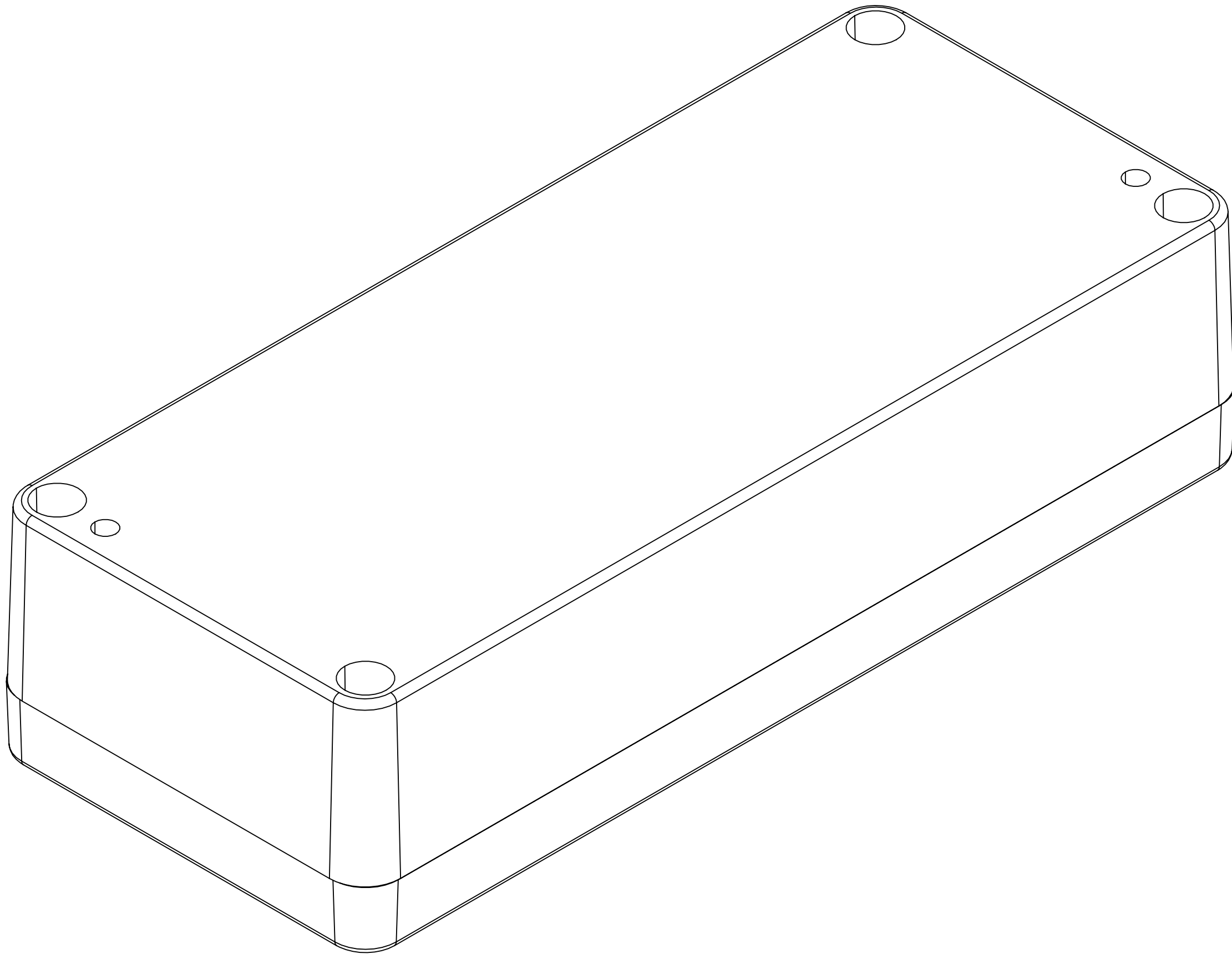

| REV. NO  | DATE    | REVISED BY            | DESCRIPTION OF CHANGE |
|--|---------|-----------------------|-----------------------|
|  <b>ALTINKAYA</b><br>Electronic Enclosures & Components |         |                       |                       |
| Customer Name:   |         | Customer Ref.:        |                       |
| Altinkaya Ref.:  |         | Part Name: SE-313-0-0 |                       |
| DRAWN  | NAME    | DATE                  | Drawn From:           |
| CHECKED  | Y.YEL   | 25.11.2024            | Weight:               |
| DIMENSIONAL TOLERANCES UNLESS OTHERWISE SPECIFIED (DIN7168)  |         |                       |                       |
|  | 0.5-3mm | 3-6mm                 | 6-30mm                |
|  | ±0.1    | ±0.1                  | ±0.2                  |
|  |         |                       | ±0.3                  |
|  |         |                       | ±0.5                  |
|  |         |                       | m (Medium)            |
| SCALE 1:1  |         |                       | SHEET 2 OF 2          |
| UNIT: mm   |         |                       | AO                    |

[www.altinkaya.com](http://www.altinkaya.com)