

BASE: 6 SURFACE

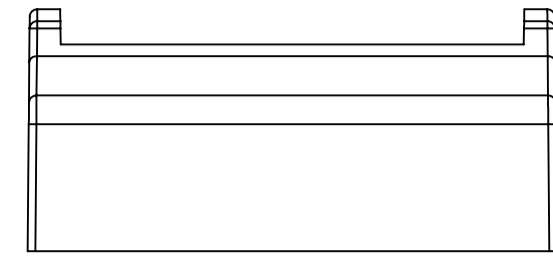

SURFACE-1

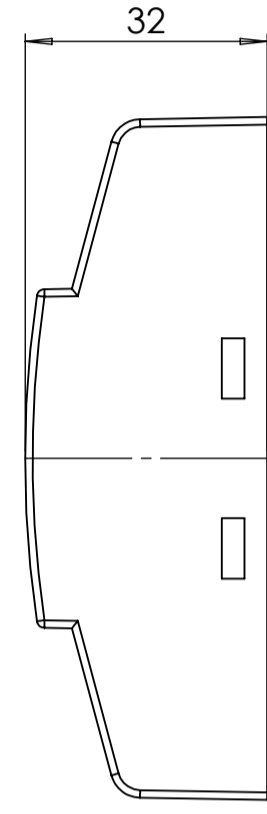

SURFACE-3

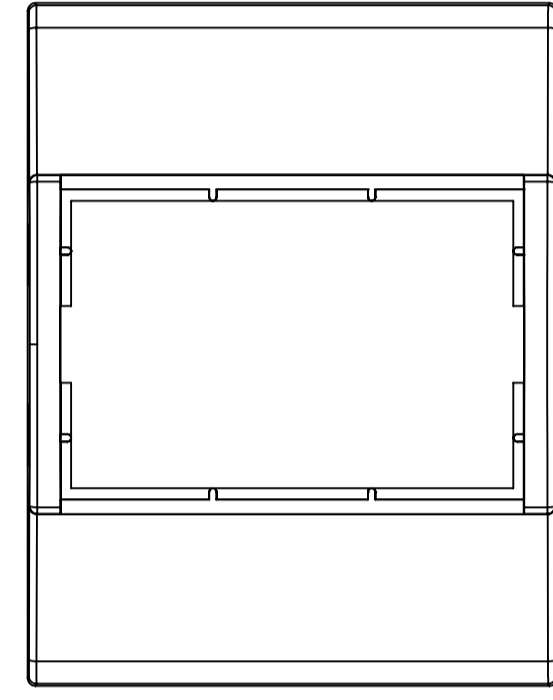

SURFACE-5

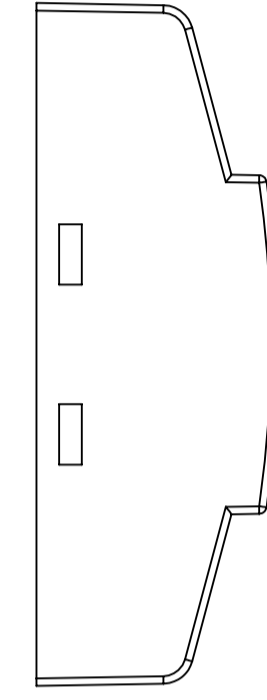

SURFACE-4

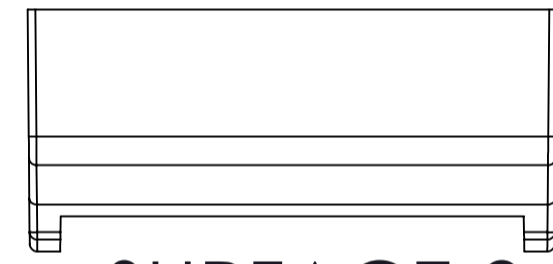

SURFACE-2

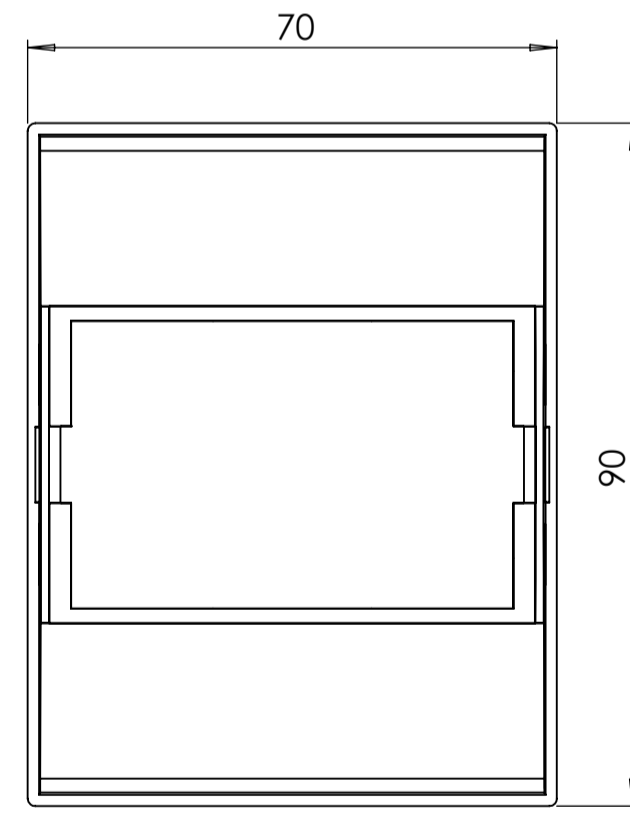
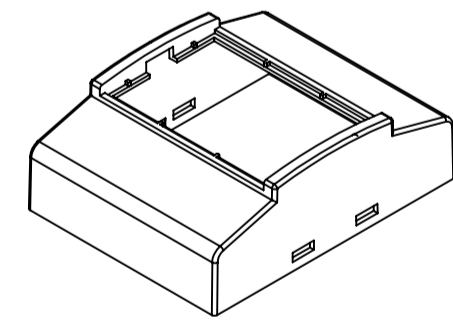

SURFACE-6 (INSIDE)

COVER: 6 SURFACE

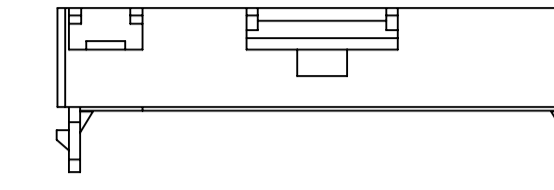

SURFACE-7

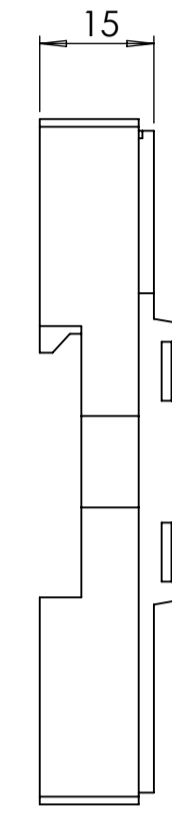

SURFACE-9

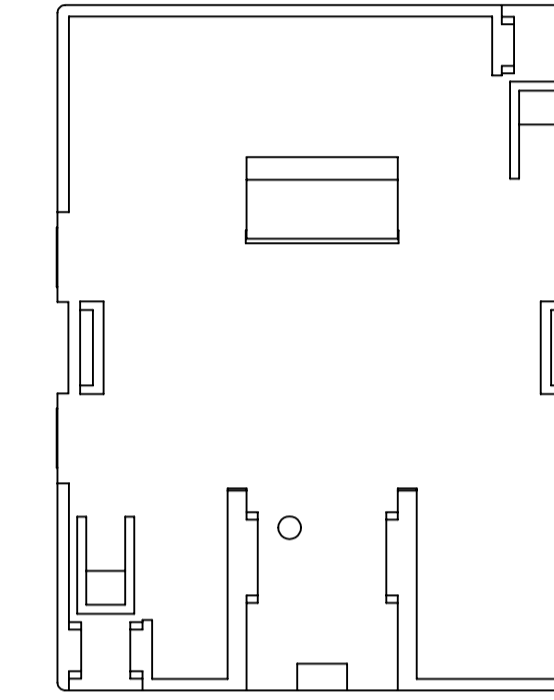

SURFACE-11

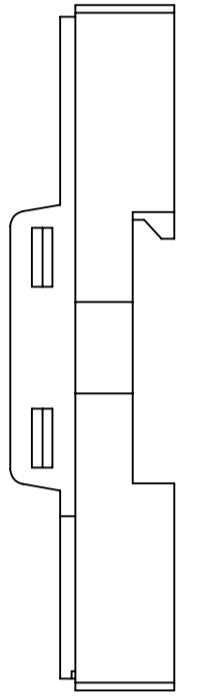

SURFACE-10

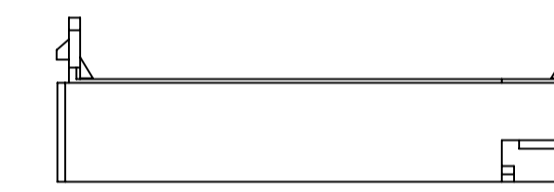

SURFACE-8

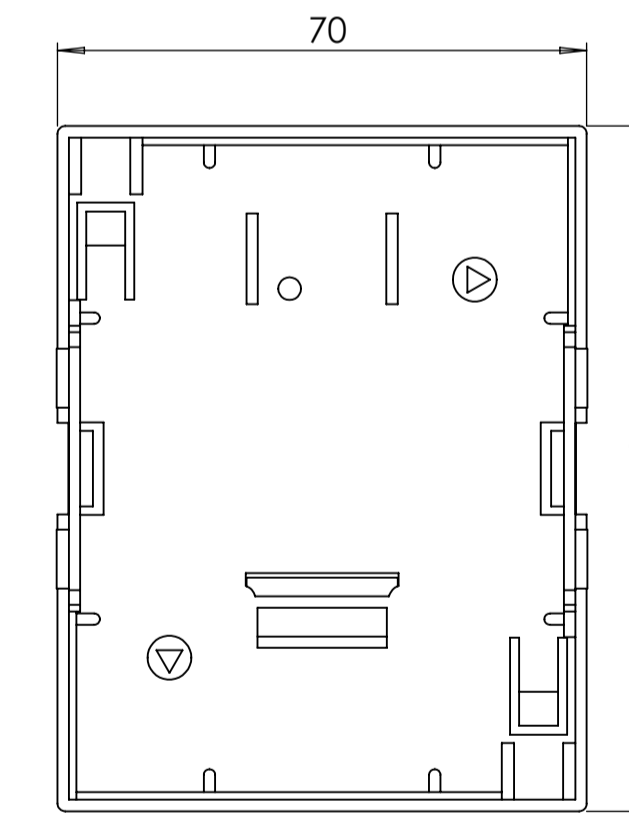
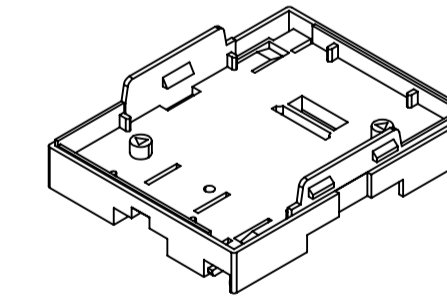

SURFACE-12 (INSIDE)

PANEL: 2 SURFACE

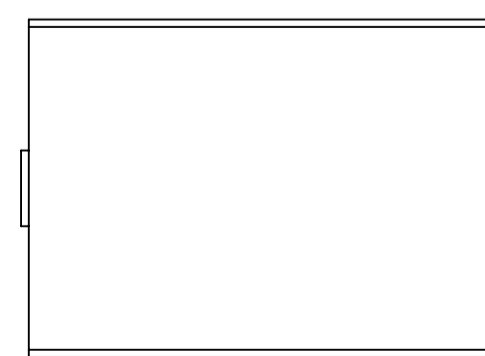
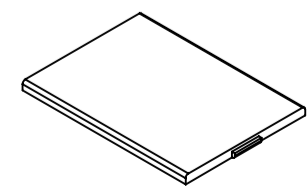

SURFACE-13

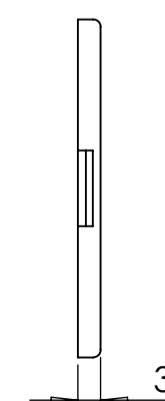

SURFACE-14 (INSIDE)

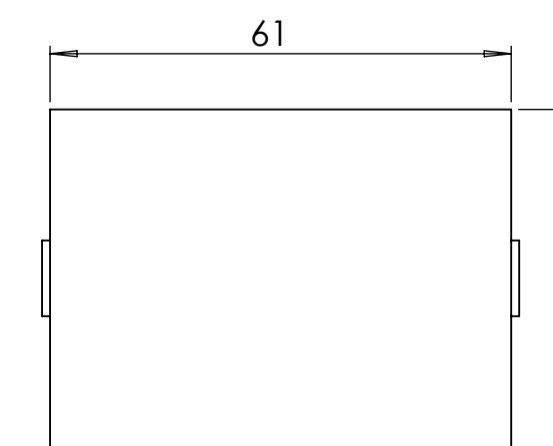

REV. NO.	DATE	REVISED BY	DESCRIPTION OF CHANGE
 ALTINKAYA Electronic Enclosures & Components www.altinkaya.com			
Customer Name:		Customer Ref.:	
Altinkaya Ref.:		Part Name: RT-504	
DRAWN	S. YESILOZ	DATE	17.09.2024
CHECKED	Y. YEL	DATE	17.09.2024
DIMENSIONAL TOLERANCES UNLESS OTHERWISE SPECIFIED:		Weight:	SCALE 1:1 UNIT : mm
(DIN7148)	±0.1	±0.1	±0.2
	±0.3	±0.3	±0.5
			Dimension(mm)
			30-120mm
			120-400mm
			m(medium)
SHEET 1 OF 2			A1

RT-504 MACHINED TOGETHER

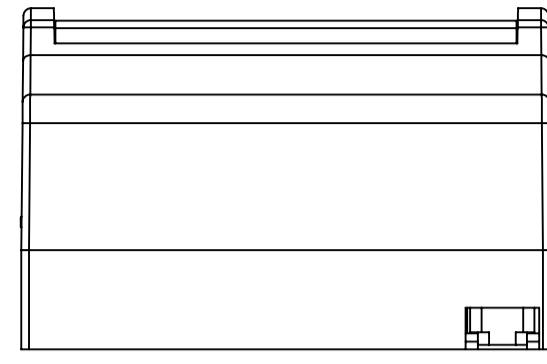

SURFACE-15

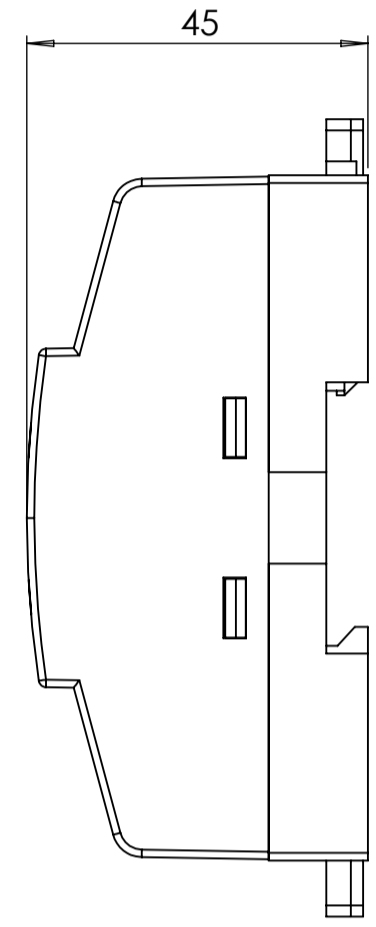

SURFACE-17

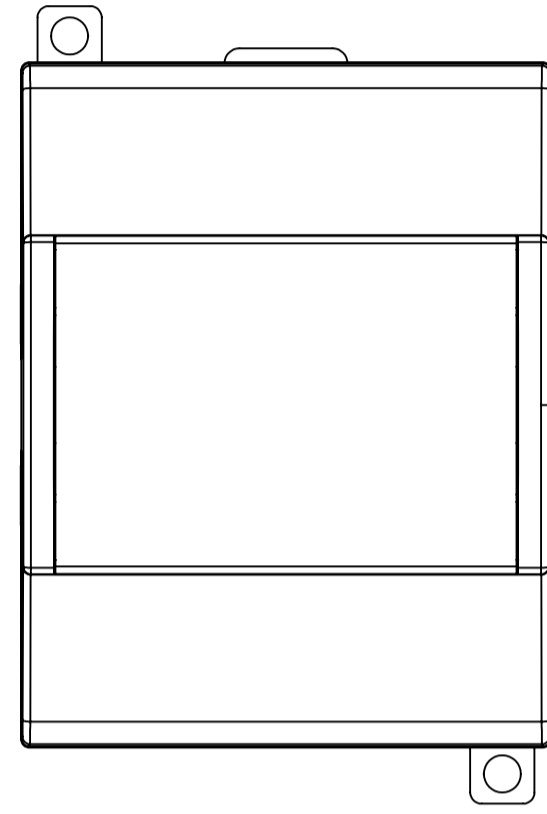

SURFACE-19

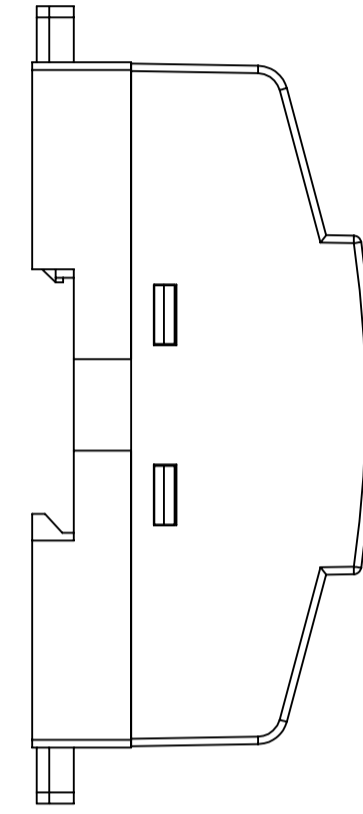

SURFACE-18

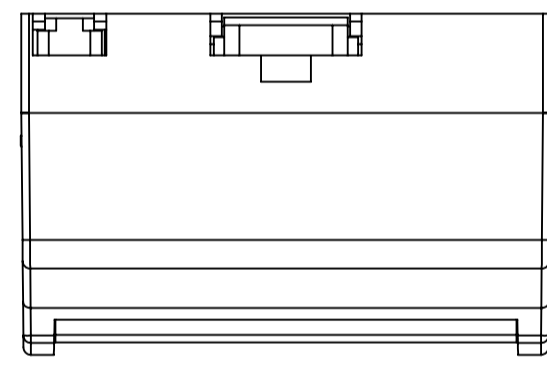
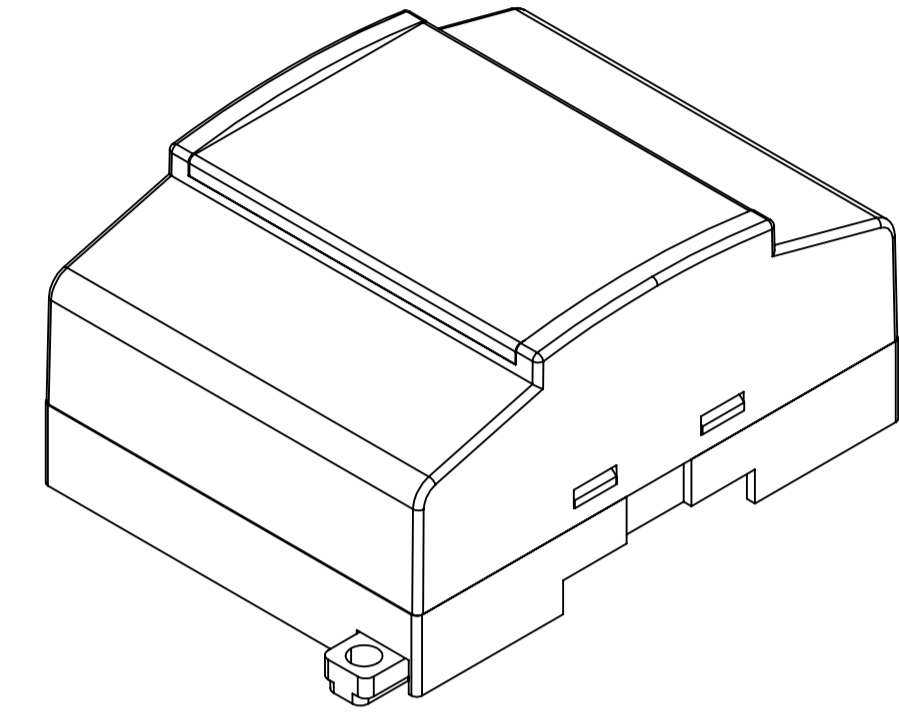

SURFACE-16

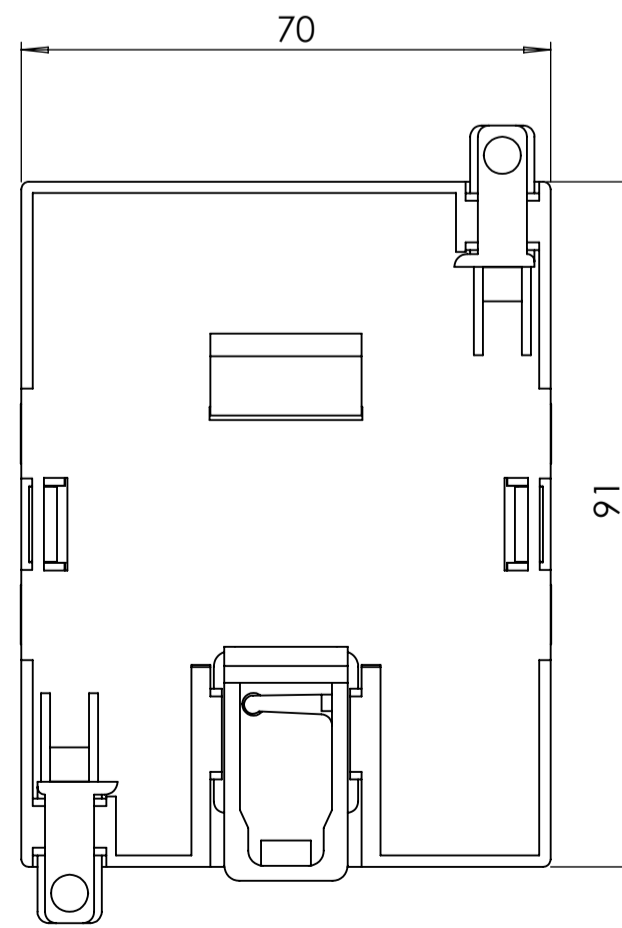

SURFACE-20

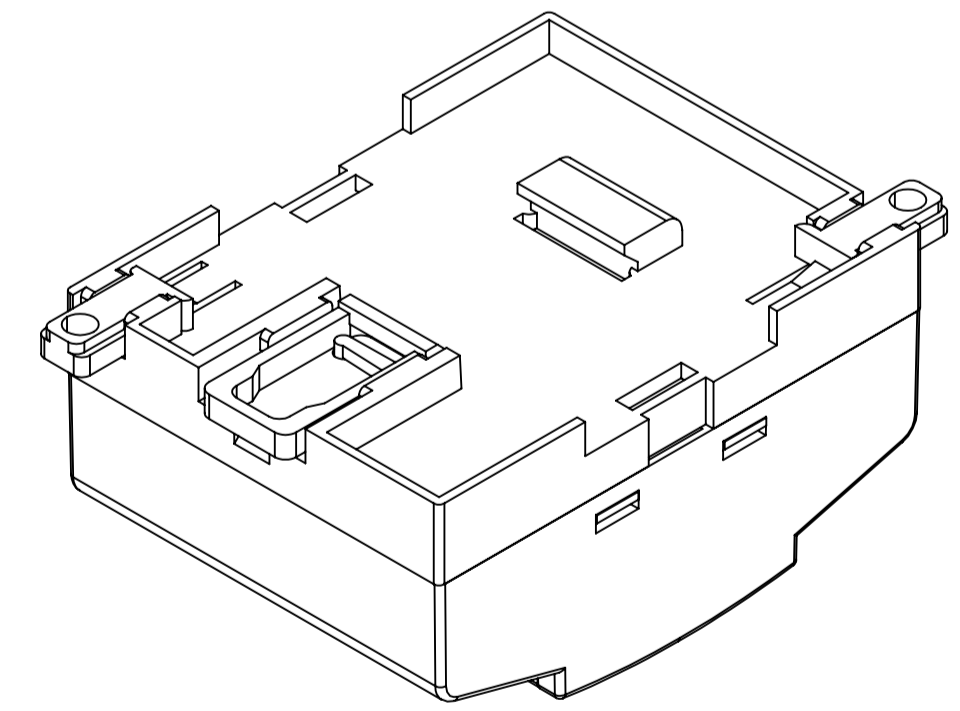

REV. NO.	DATE	REVISED BY	DESCRIPTION OF CHANGE
www.altinkaya.com			
Customer Name:		Customer Ref.:	
Altinkaya Ref.:		Part Name: RT-504	
DRAWN	NAME	DATE	Drawn From:
CHECKED	Y. YESLOZ	17.09.2024	Material:
DIMENSIONAL TOLERANCES UNLESS OTHERWISE SPECIFIED:			SCALE 1:1 UNIT : mm
(DIN7148)	±0.1	±0.1	±0.2 ±0.3 ±0.5
	3-6mm	6-30mm	30-120mm 120-400mm
			Dimension(mm) m(medium)
SHEET 2 OF 2			A1