

BASE: 6 SURFACE

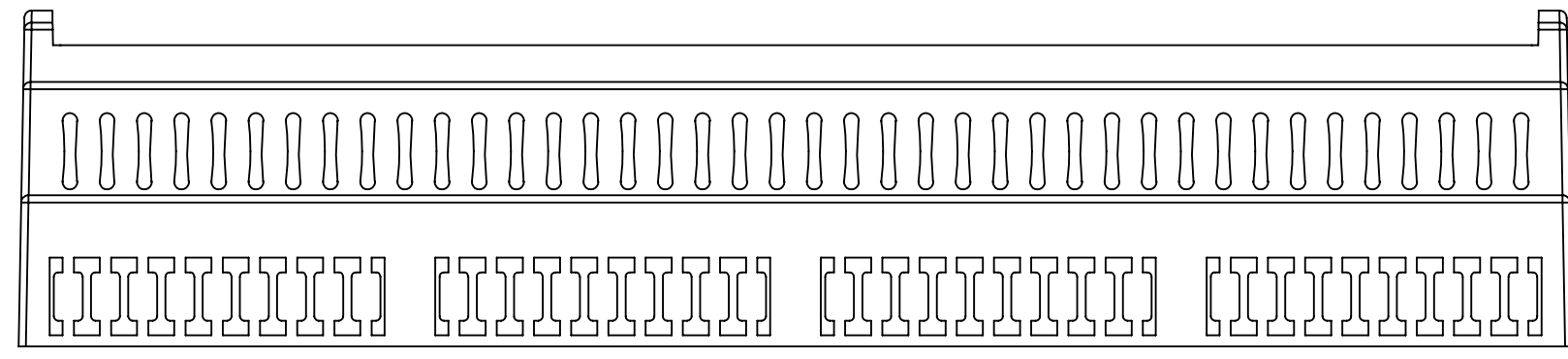

SURFACE-1

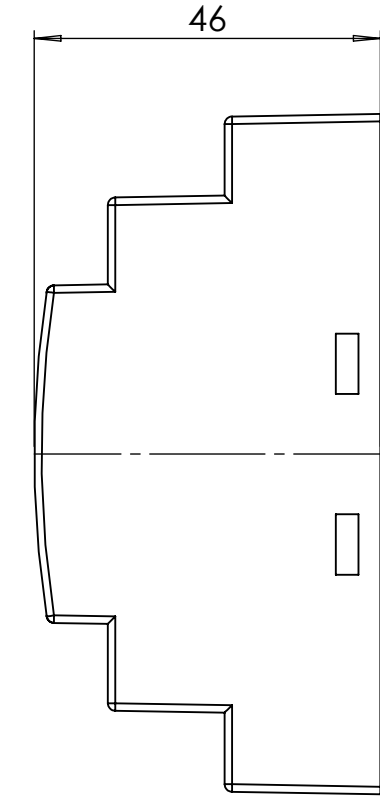

SURFACE-3

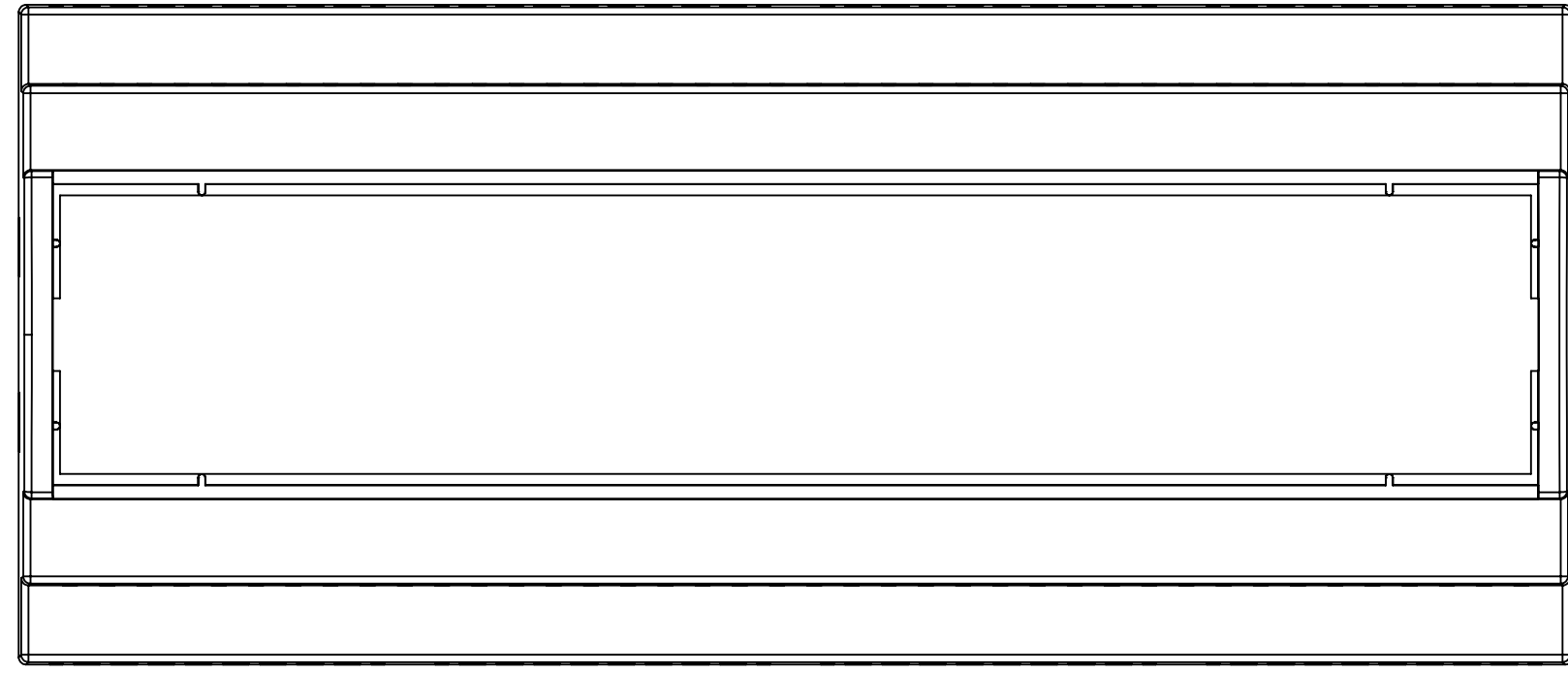

SURFACE-5

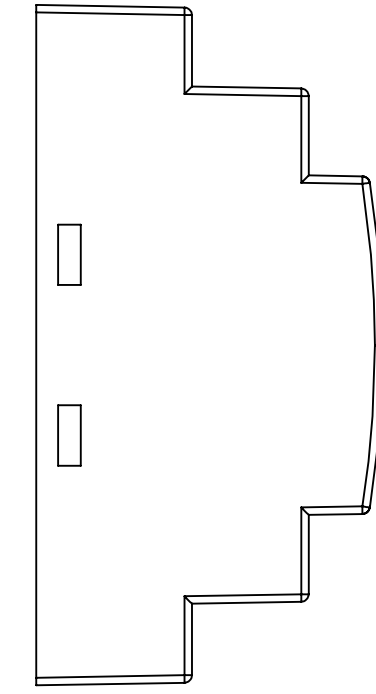

SURFACE-4

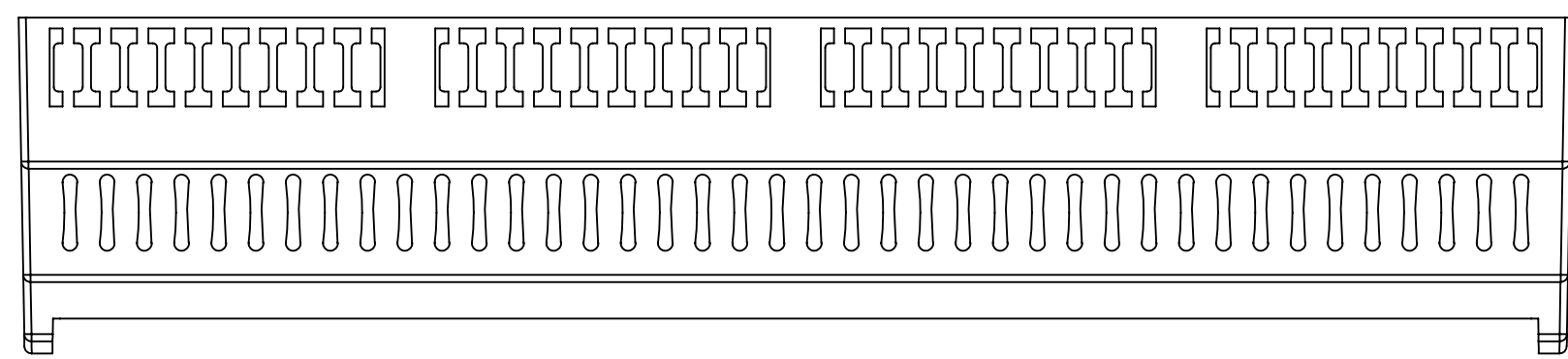

SURFACE-2

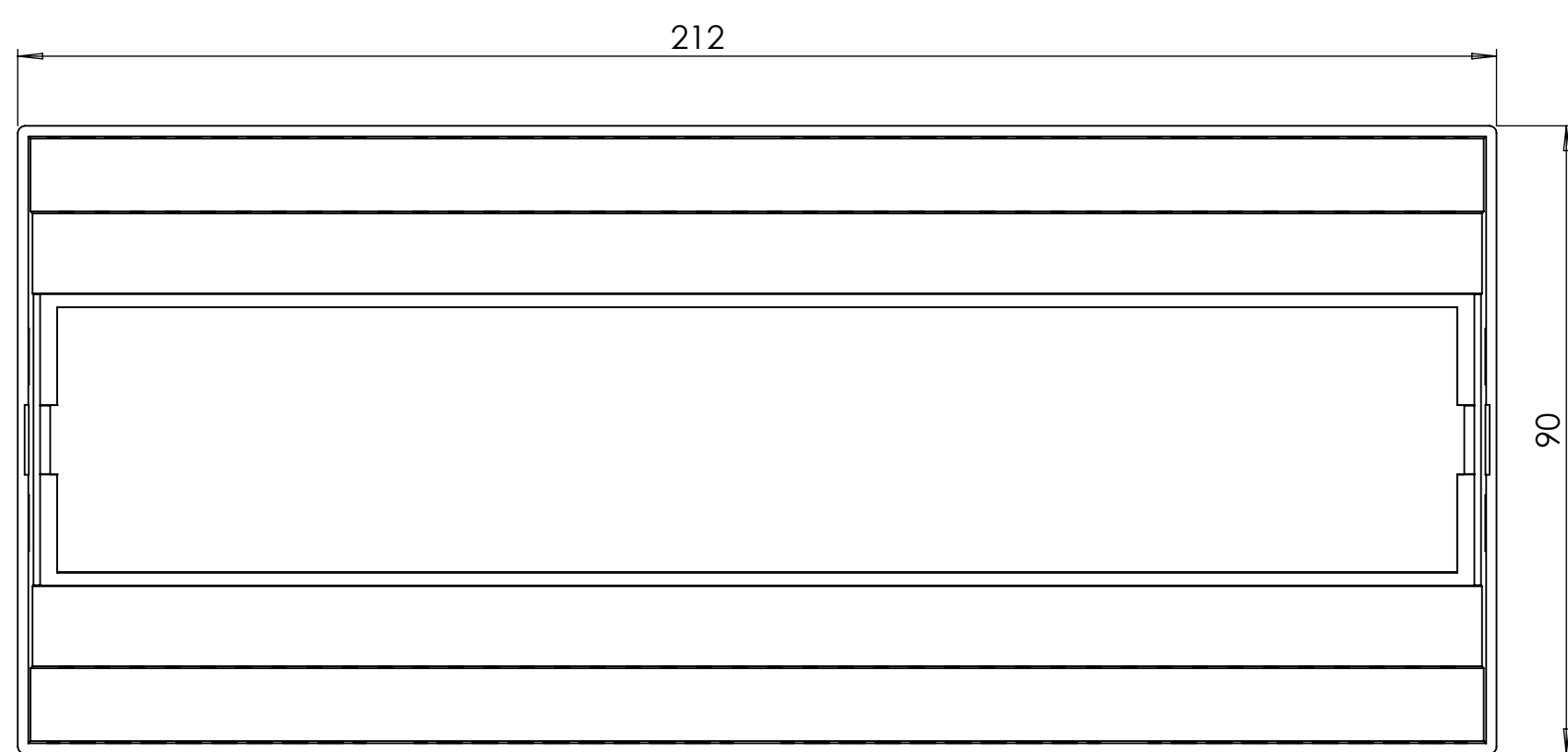
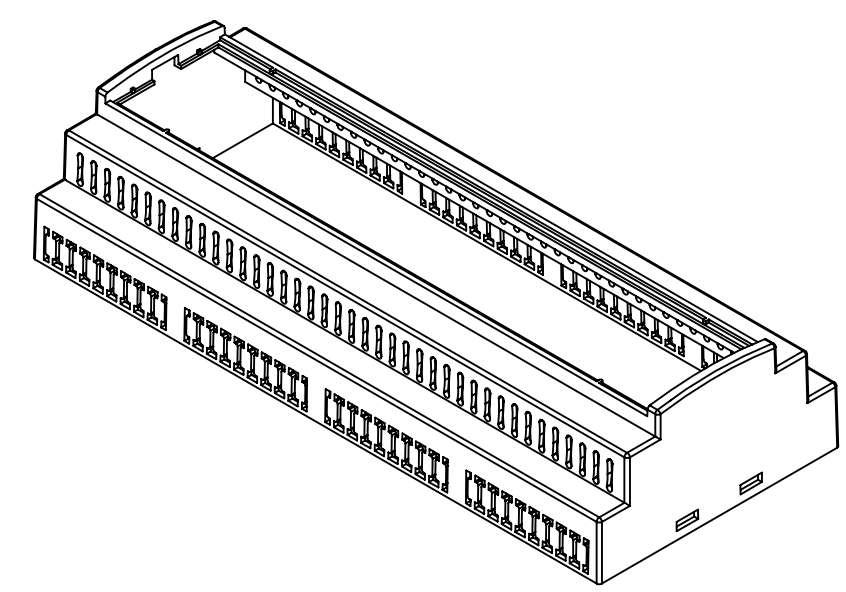

SURFACE-6 (INSIDE)

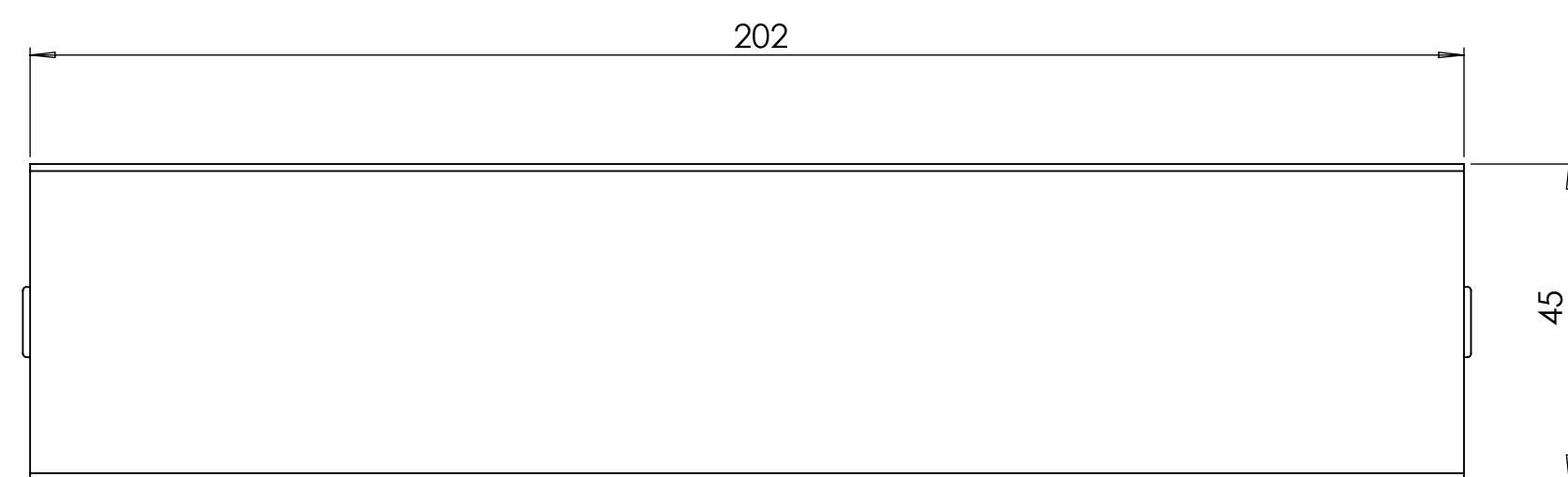
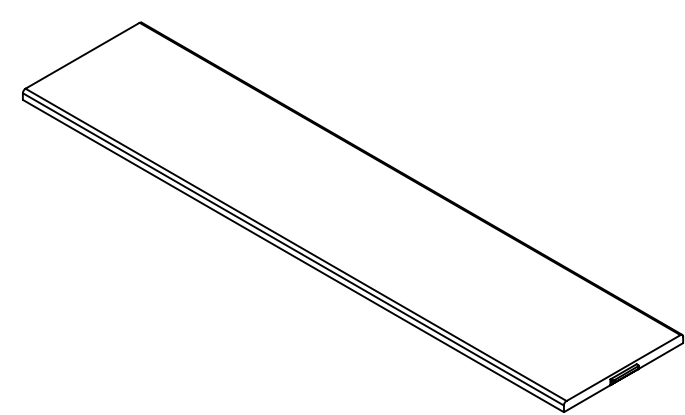

SURFACE-13

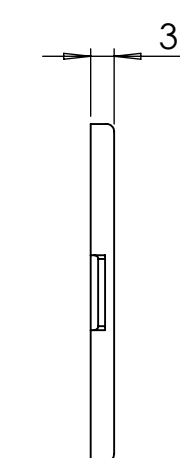

SURFACE-14 (INSIDE)

PANEL: 2 SURFACE

COVER: 6 SURFACE



SURFACE-7

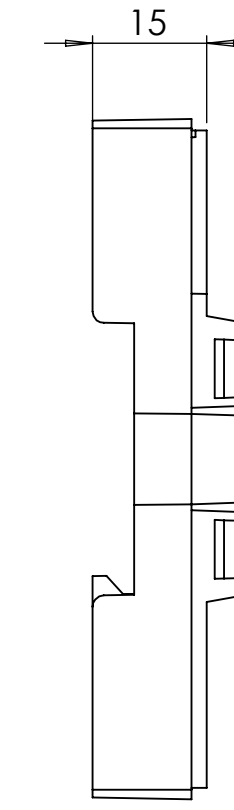

SURFACE-9

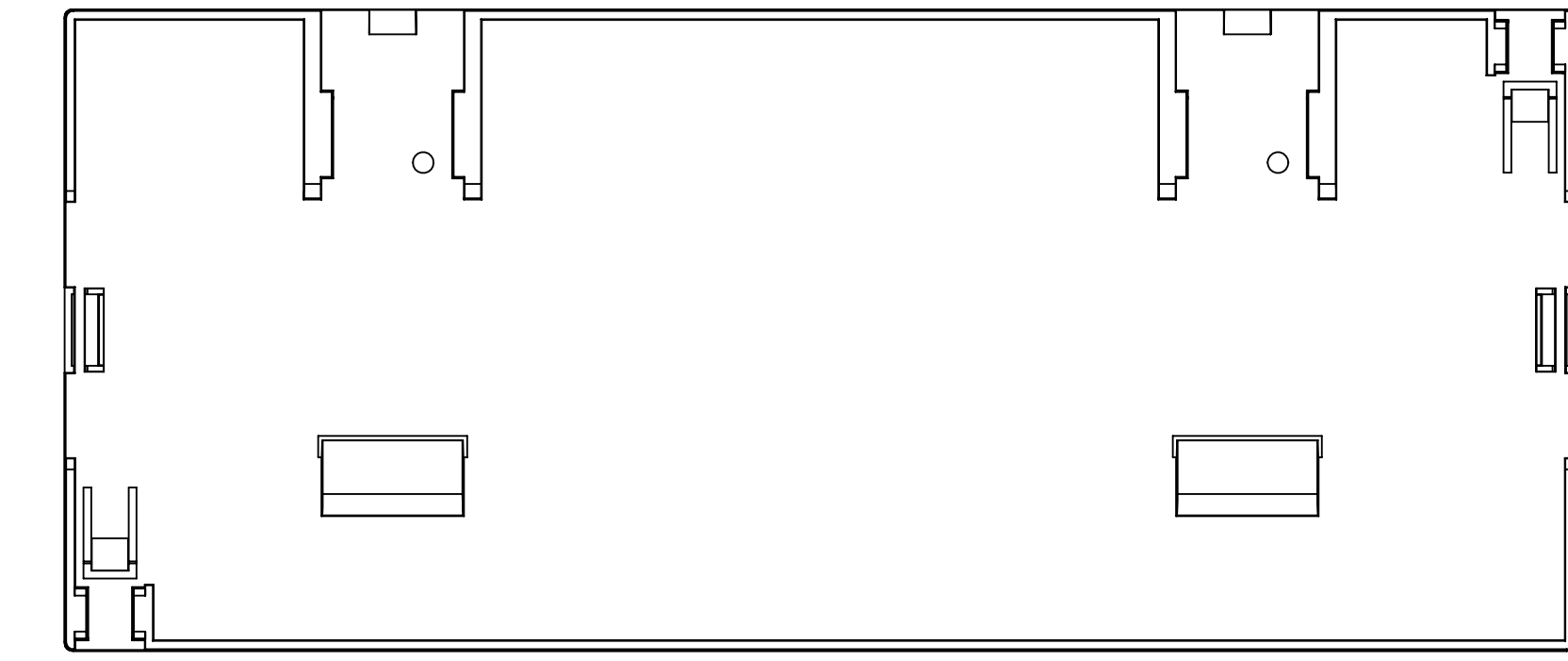

SURFACE-11

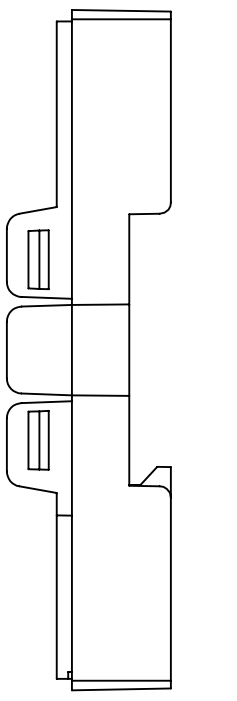

SURFACE-10

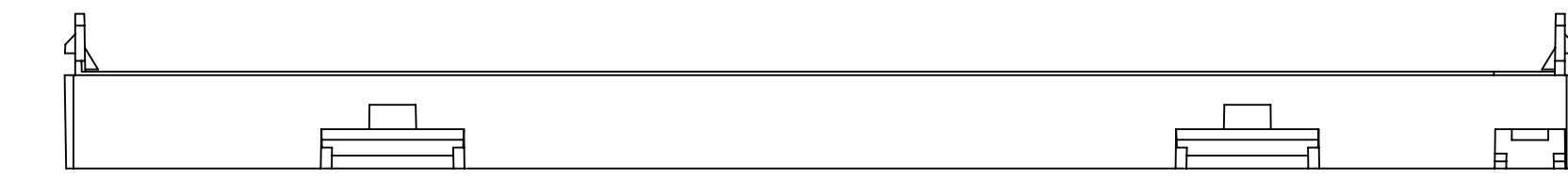

SURFACE-8

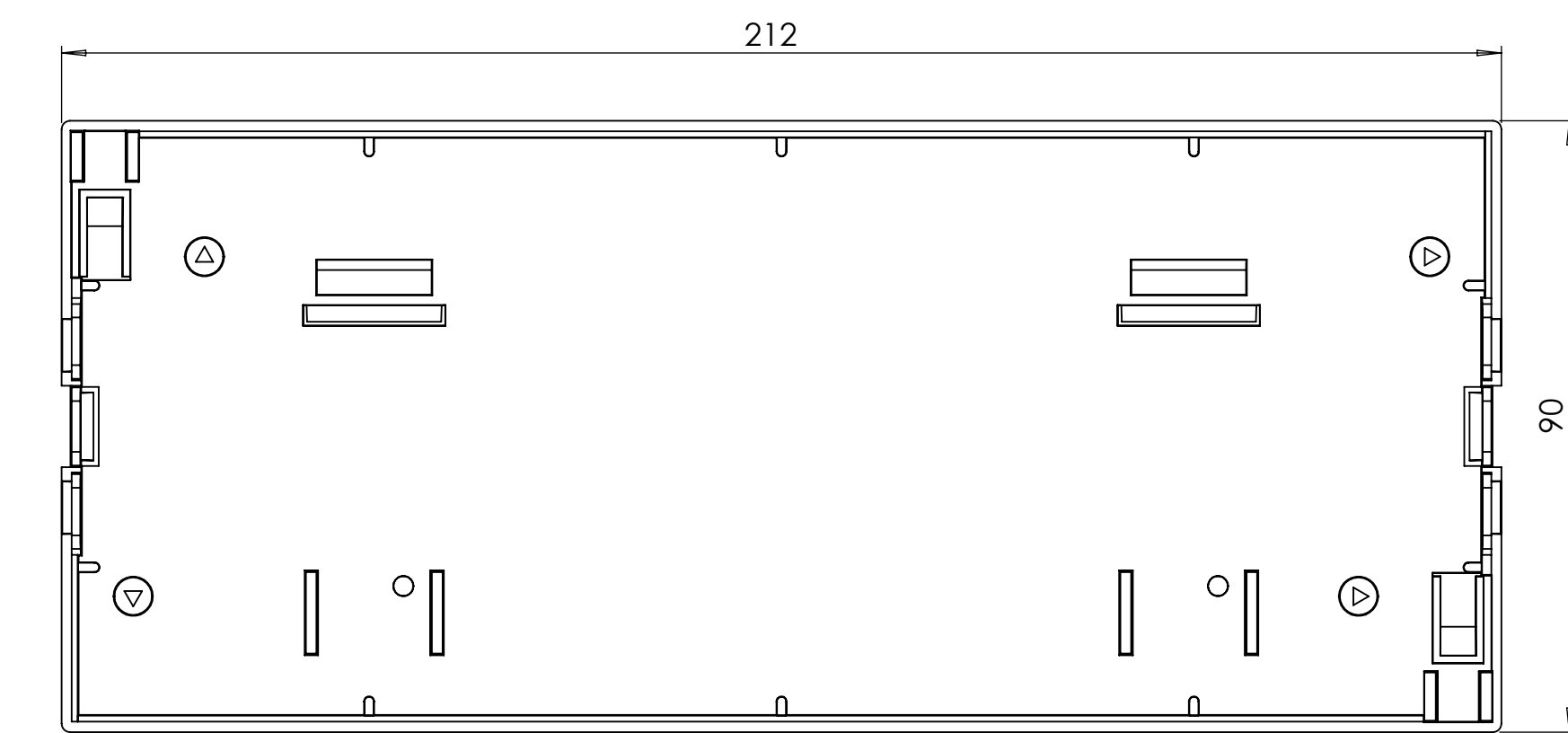
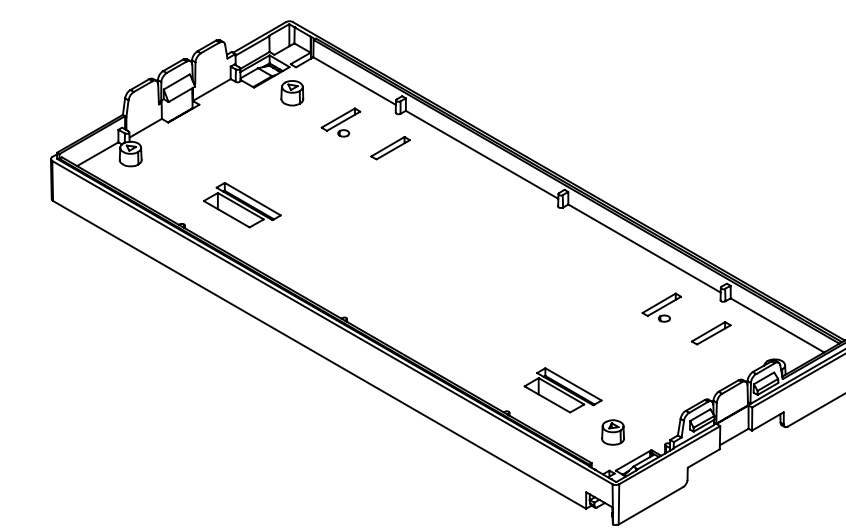

SURFACE-12 (INSIDE)

REV. NO	DATE	REVISED BY	DESCRIPTION OF CHANGE
ALTINKAYA Electronic Enclosures & Components			www.altinkaya.com
Customer Name:		Customer Ref.:	
Altinkaya Ref.:		Part Name: RT-212-D	
DRAWN	NAME	DATE	Drawn From:
	S.YESILOZ	16.09.2024	
CHECKED	Y.YEL	16.09.2024	Weight:
DIMENSIONAL TOLERANCES UNLESS OTHERWISE SPECIFIED (DIN7168)			
	0.5-3mm	3-6mm	6-30mm
	±0.1	±0.1	±0.2
			±0.3
			±0.5
			m (Medium)
SCALE 1:1			SHEET 1 OF 2
UNIT: mm			A0

RT-212-D IF MACHINED TOGETHER

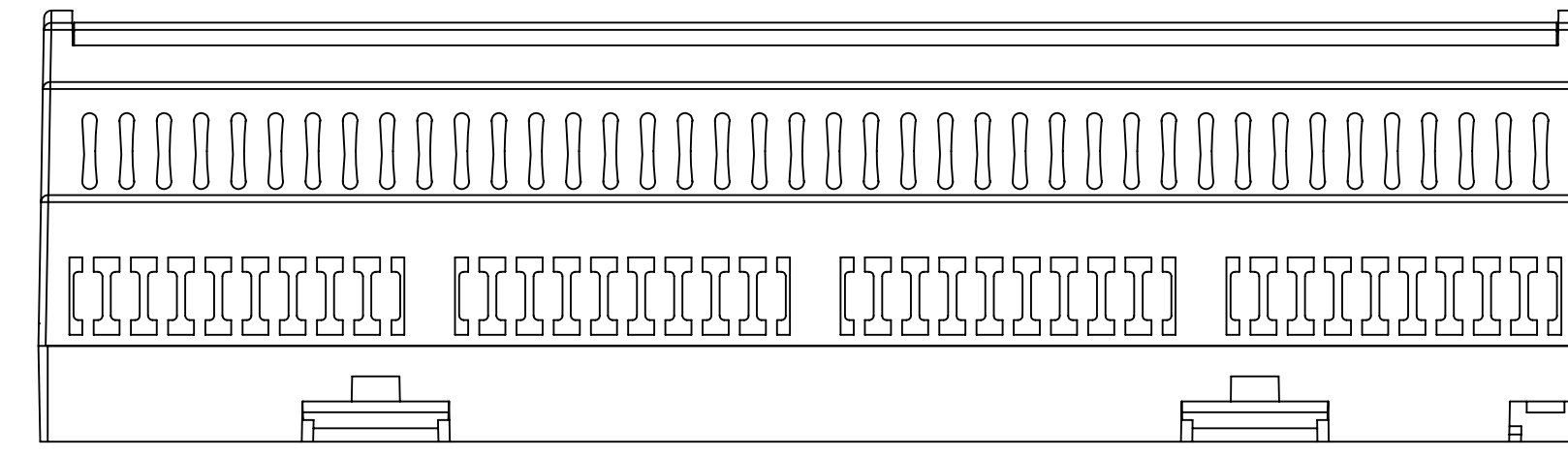

SURFACE-15

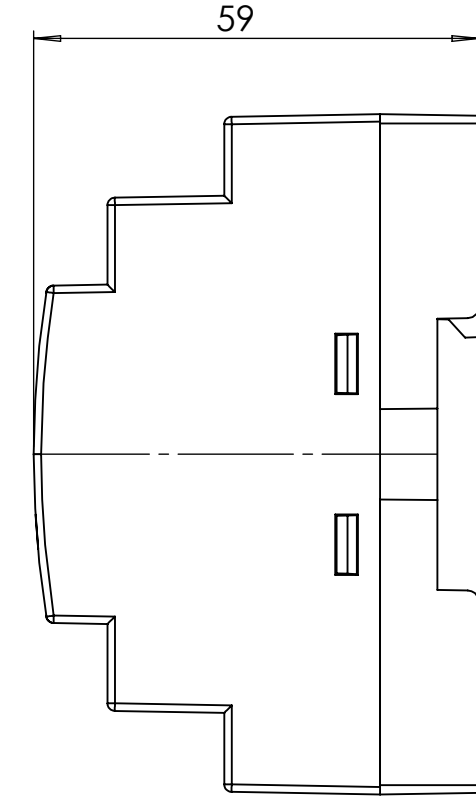

SURFACE-17

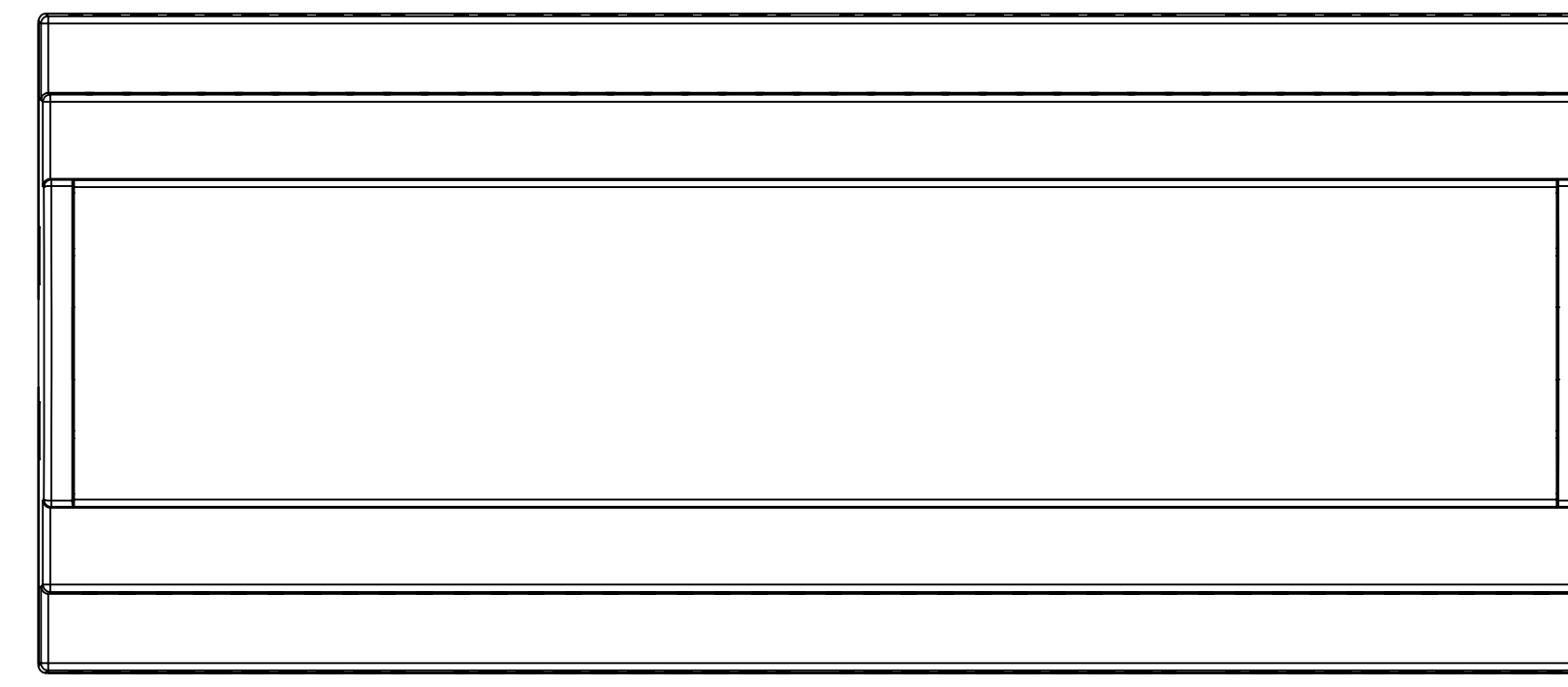

SURFACE-19

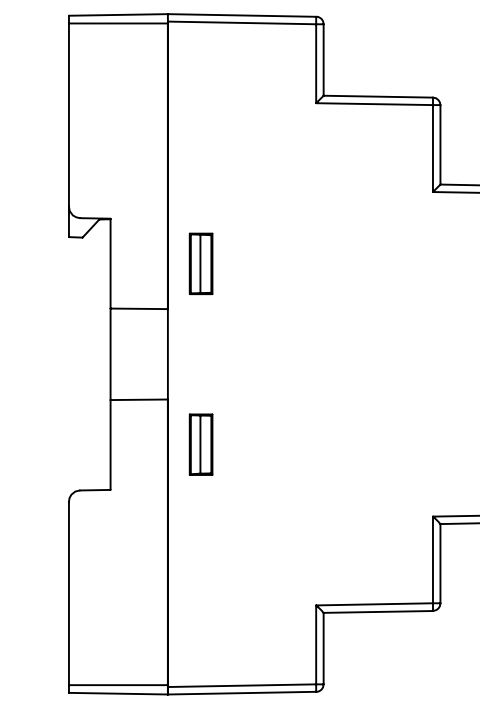

SURFACE-18

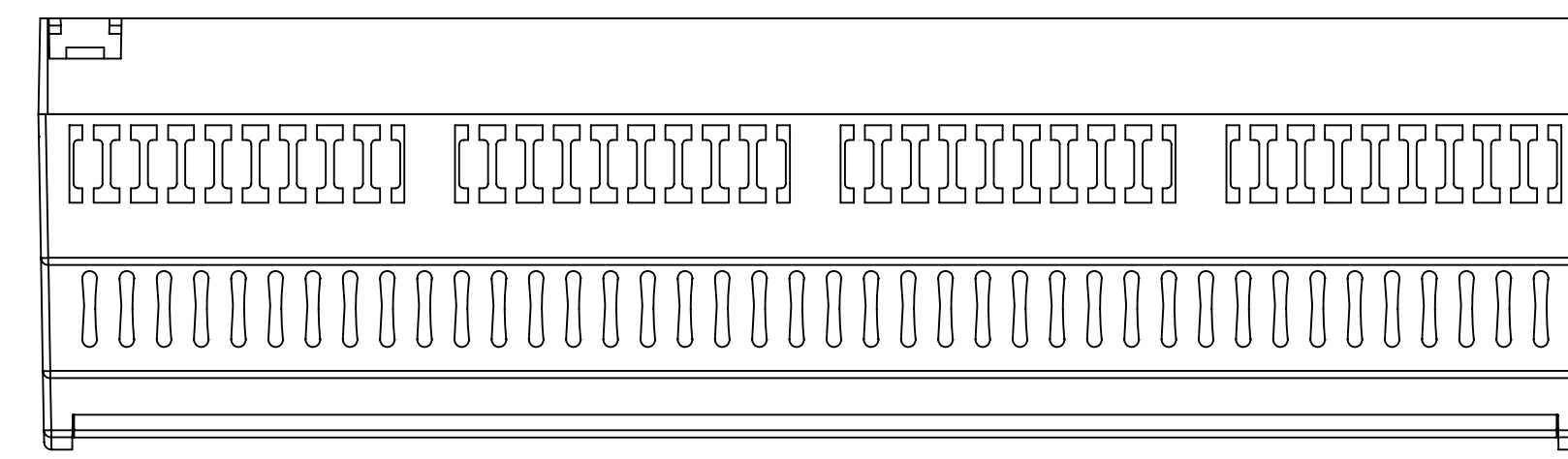
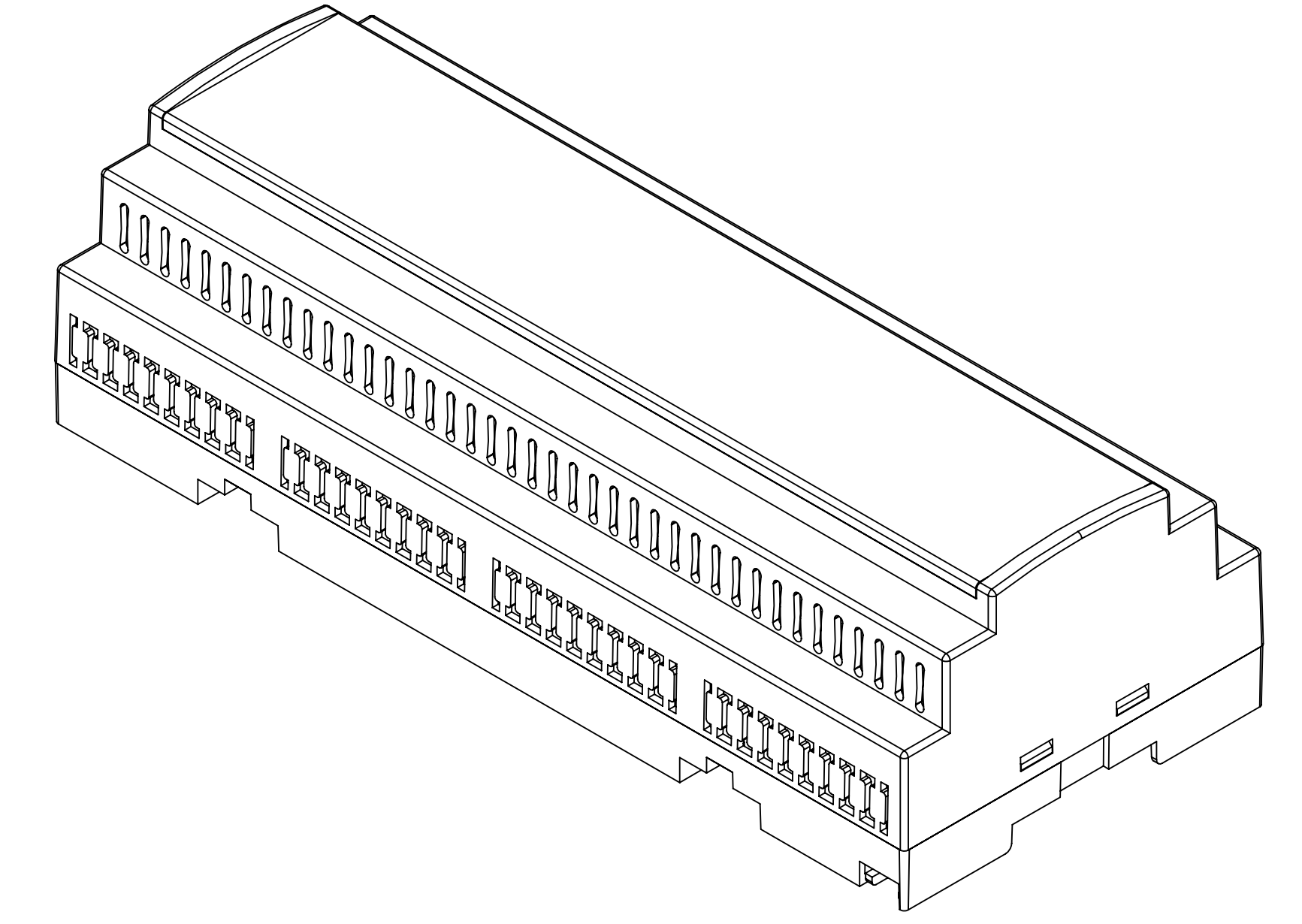

SURFACE-16

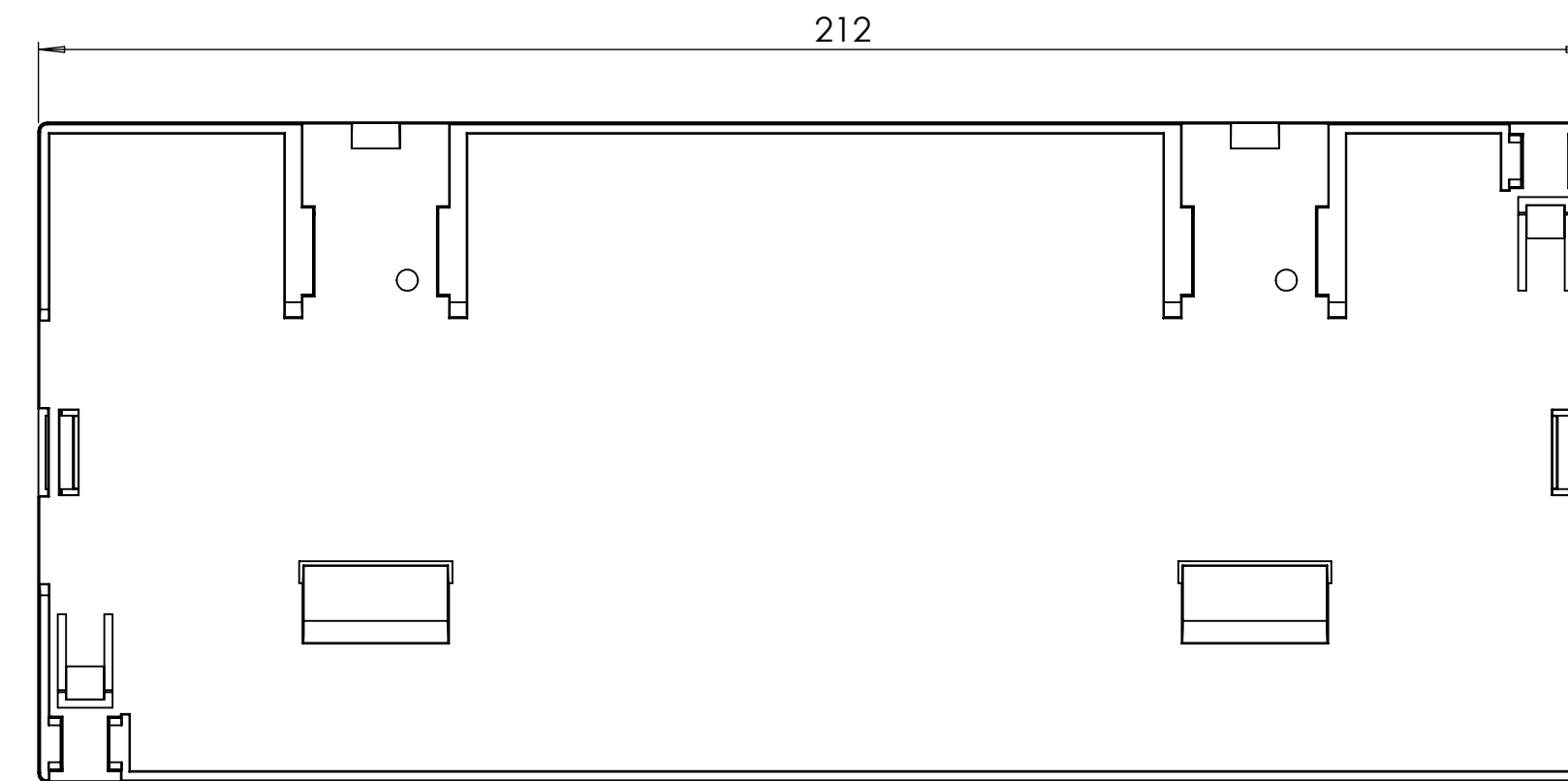

SURFACE-20

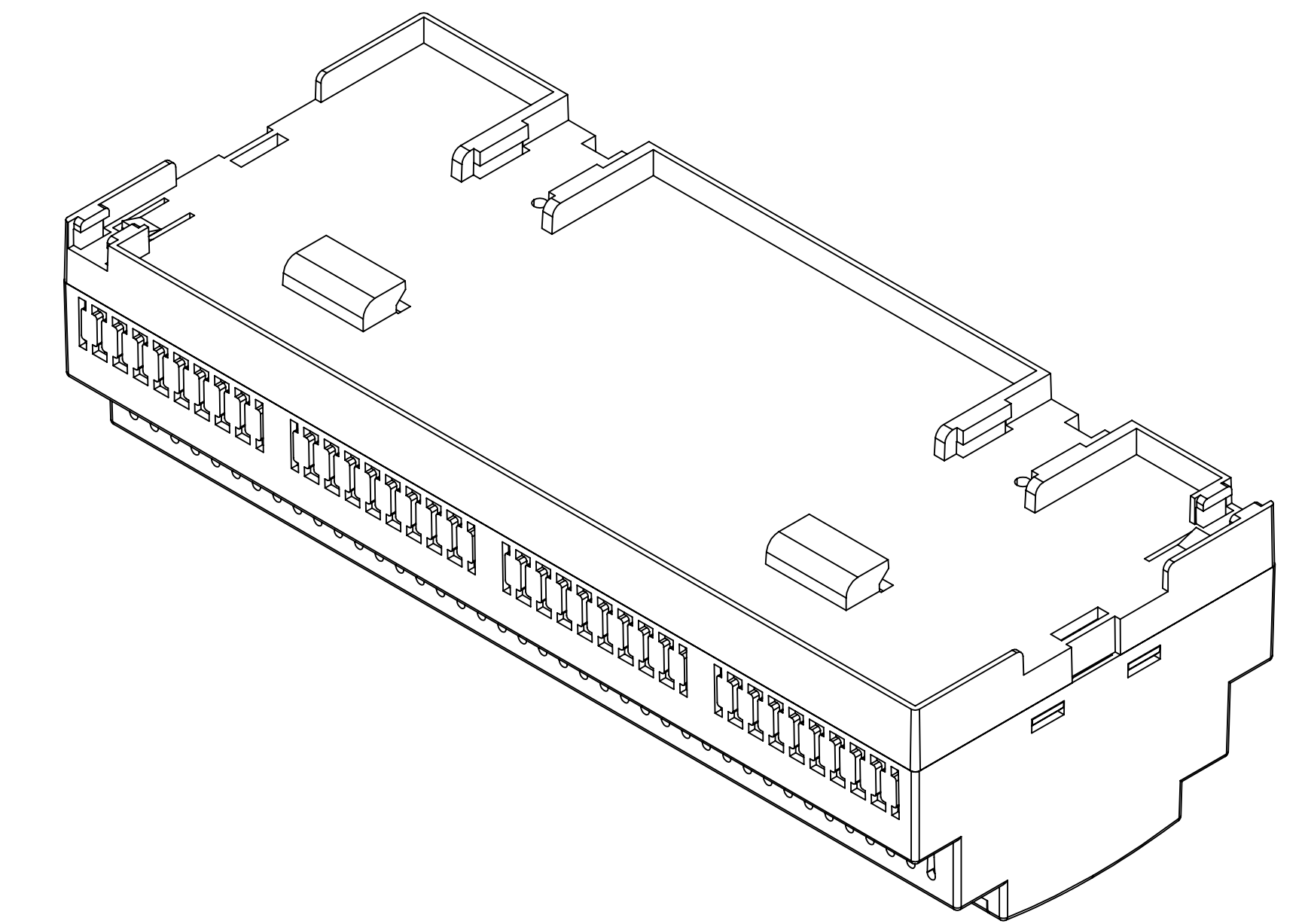

REV. NO	DATE	REVISED BY	DESCRIPTION OF CHANGE
ALTINKAYA Electronic Enclosures & Components			
Customer Name:		Customer Ref. :	
Altinkaya Ref. :		Part Name: RT-212-D	
DRAWN	NAME	DATE	Drawn From :
CHECKED	Y.YEL	16.09.2024	Weight :
DIMENSIONAL TOLERANCES UNLESS OTHERWISE SPECIFIED (DIN7168)			
0.5-3mm	3-6mm	6-30mm	30-120mm
±0.1	±0.1	±0.2	±0.3
			120-400mm
			±0.5
			m (Medium)
			SCALE 1:1
			SHEET 2 OF 2
			UNIT: mm
			A0

www.altinkaya.com