

**BASE: 6 SURFACE**

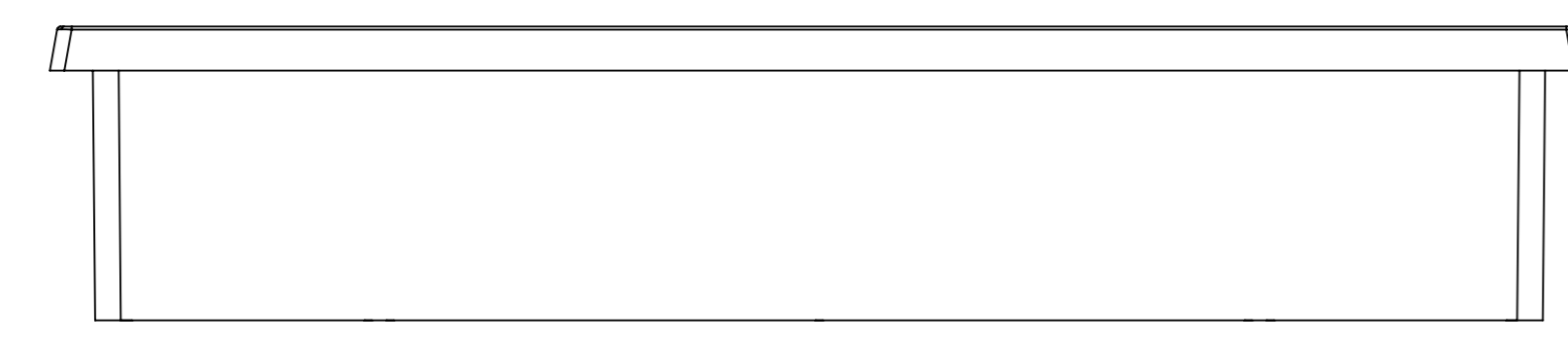

SURFACE-1

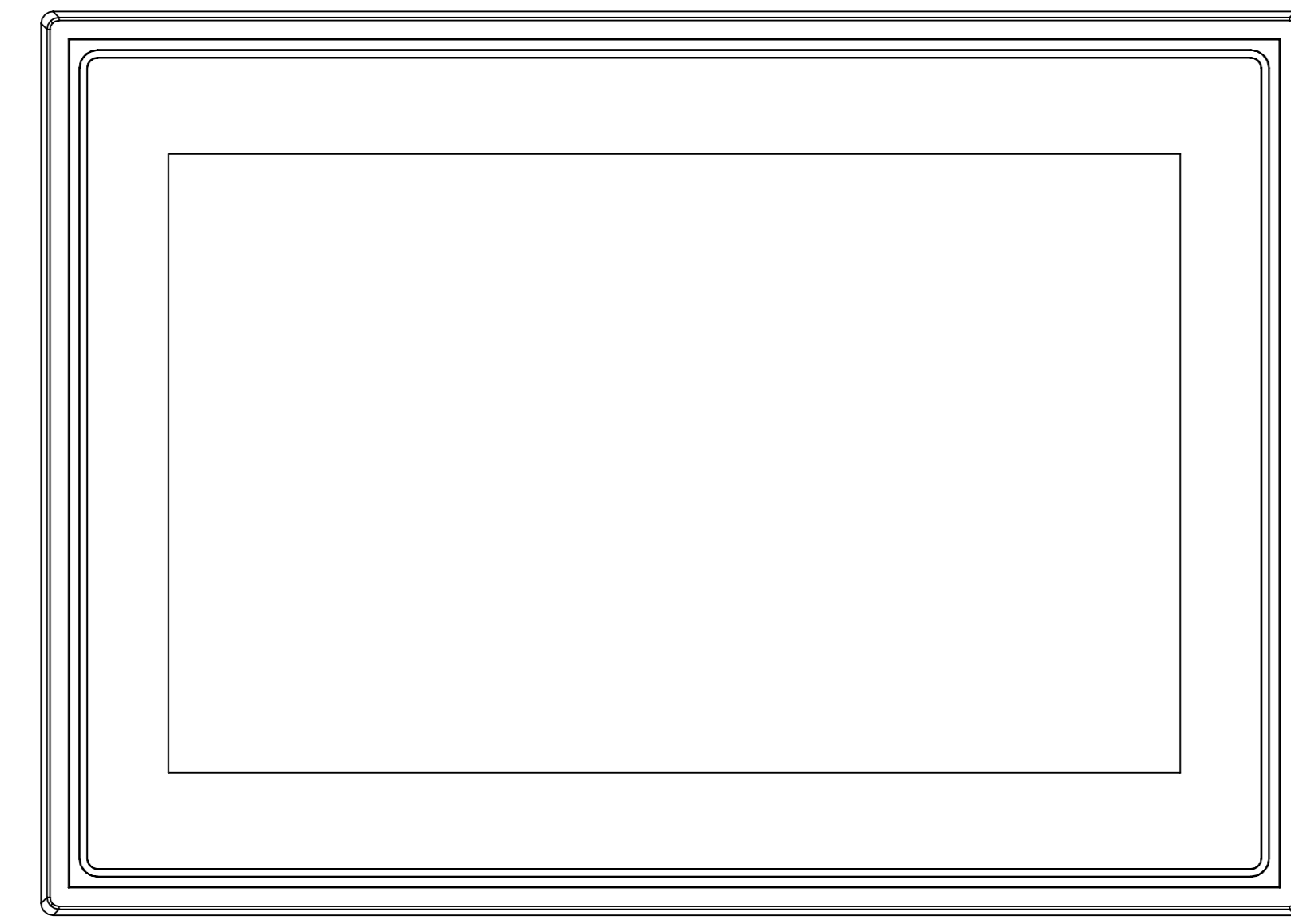

SURFACE-5

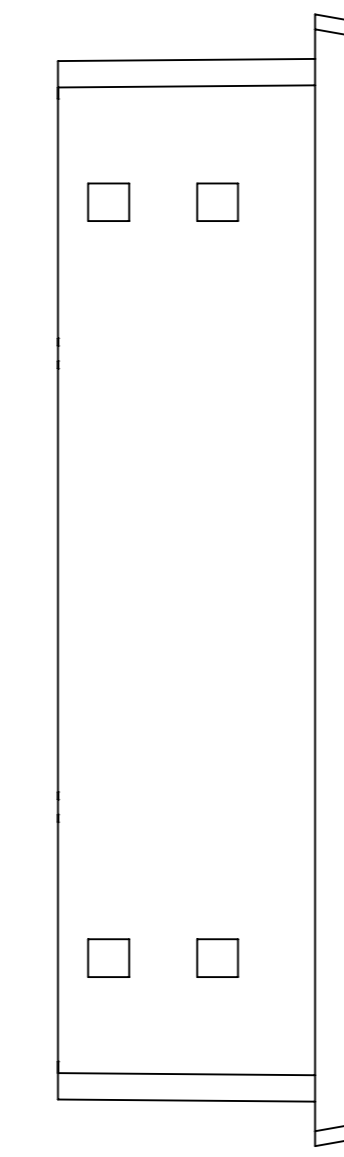

SURFACE-4

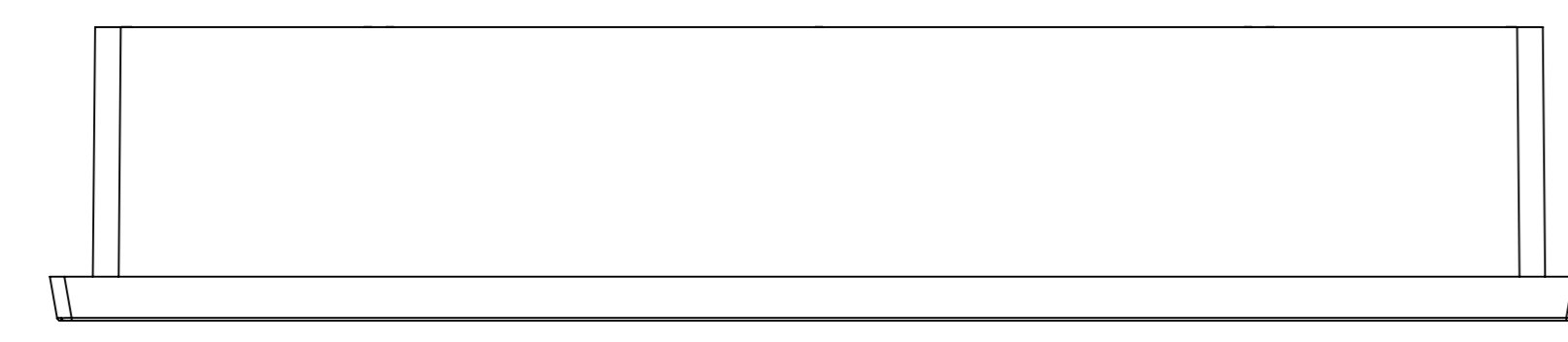

SURFACE-2

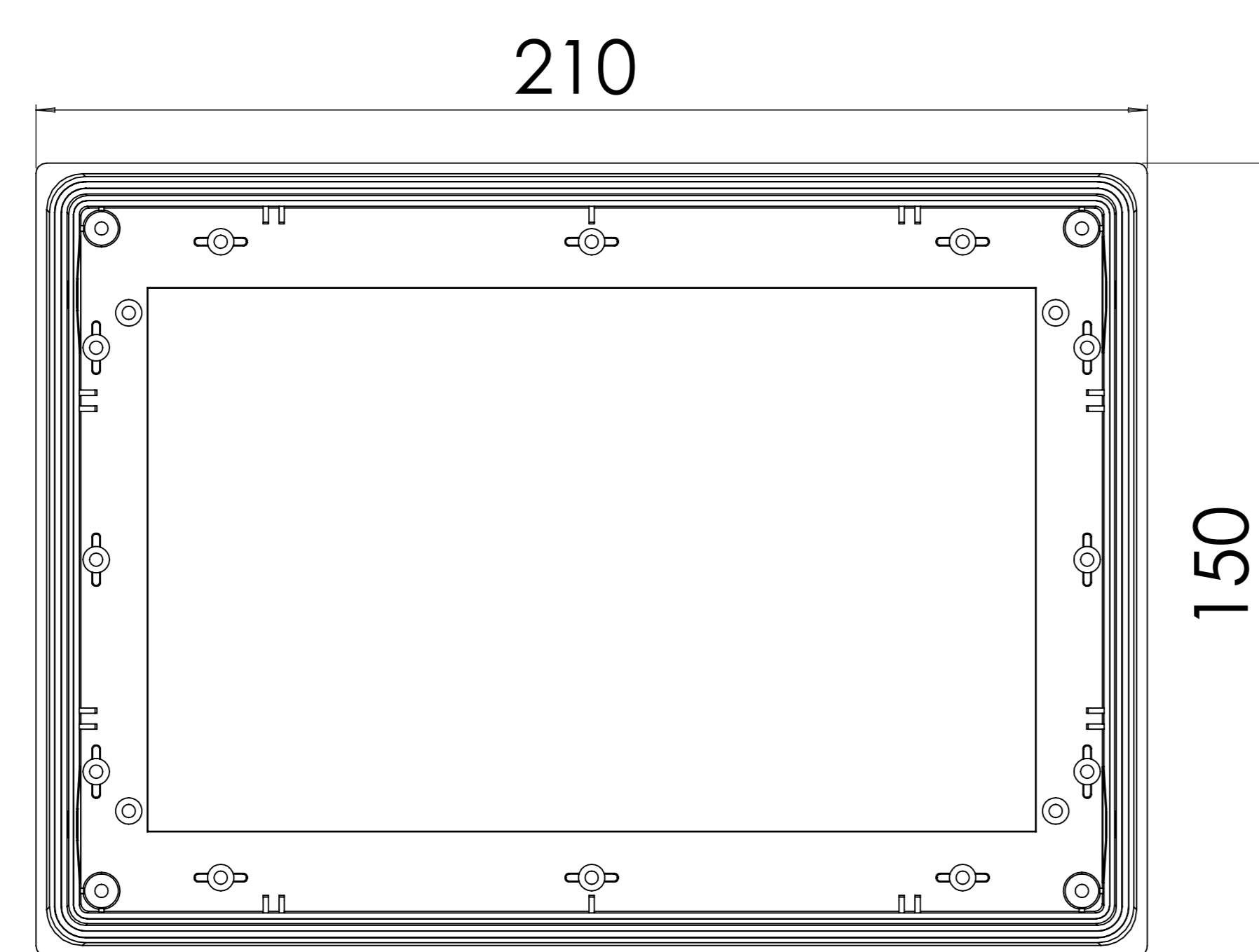

SURFACE-6 (INSIDE)

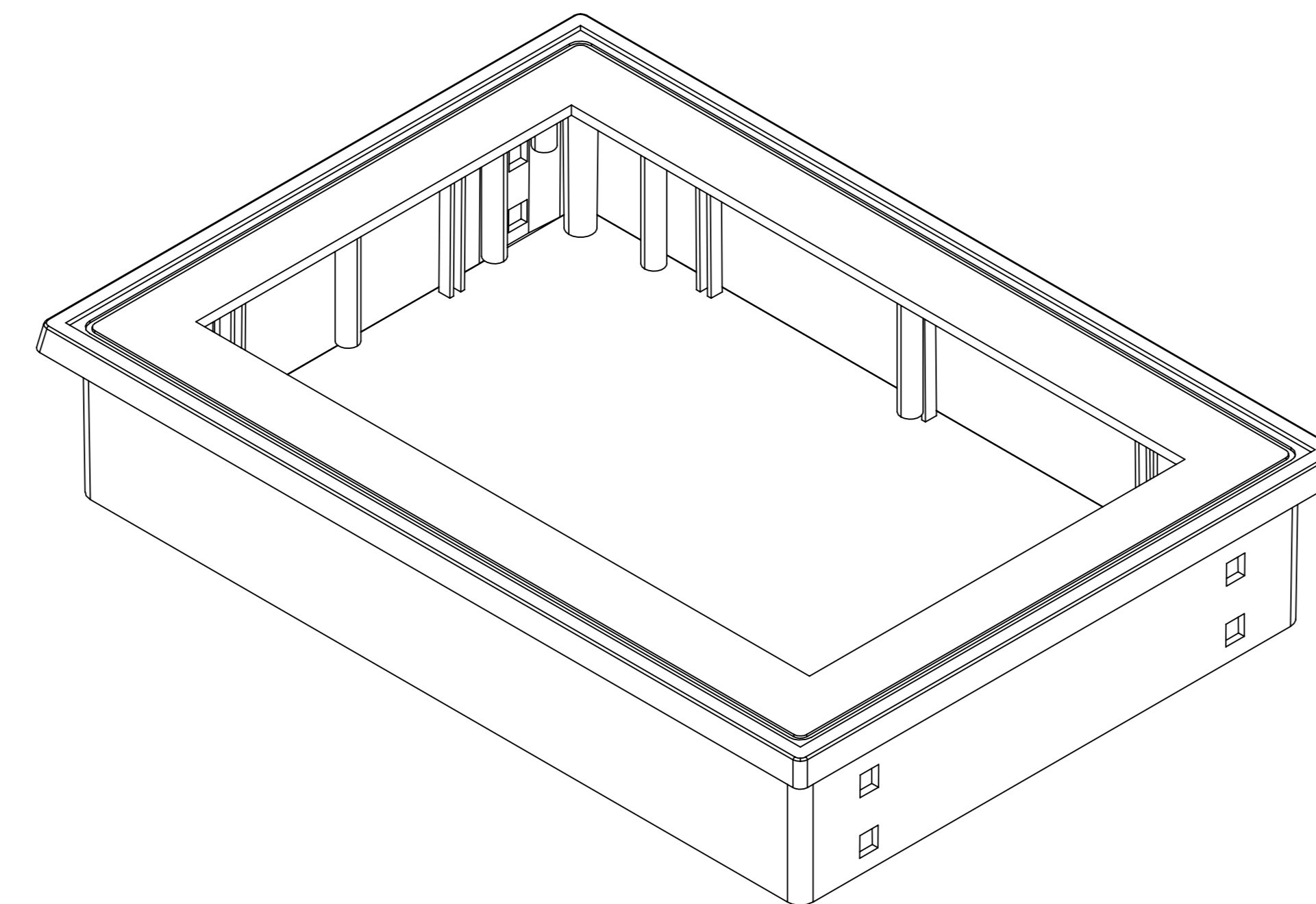

**COVER: 6 SURFACE**

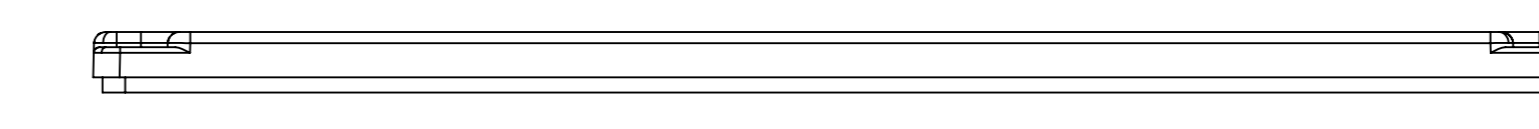

SURFACE-7

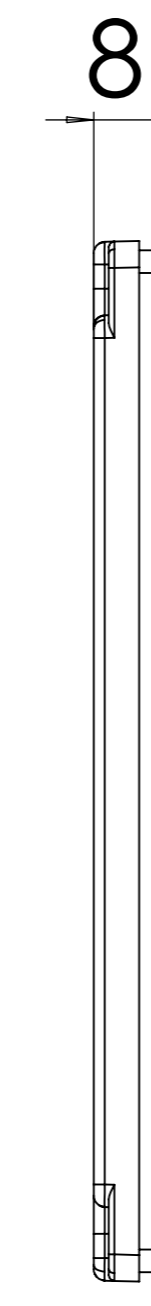

SURFACE-9

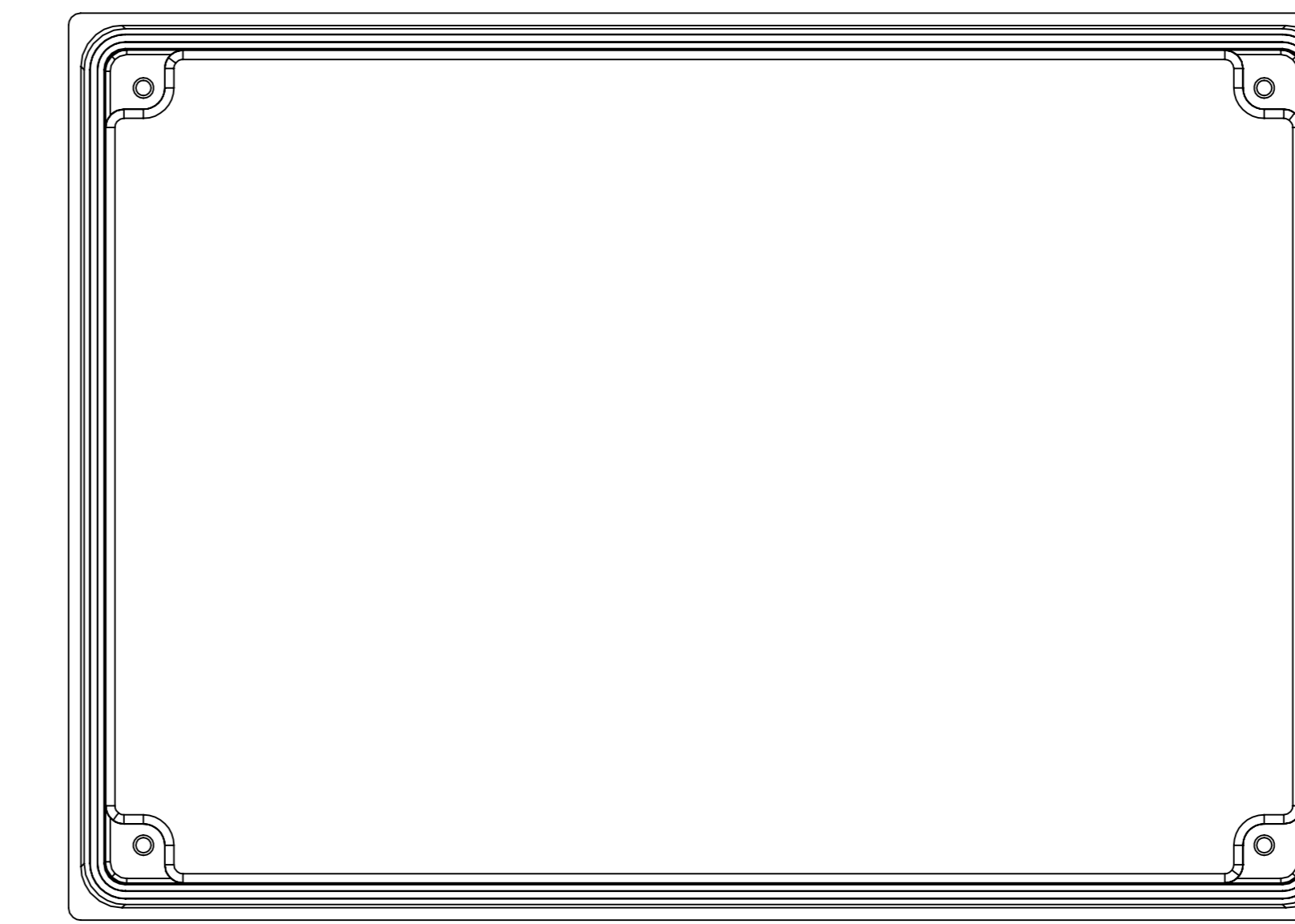

SURFACE-11

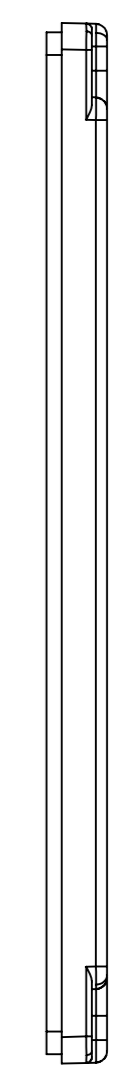

SURFACE-10

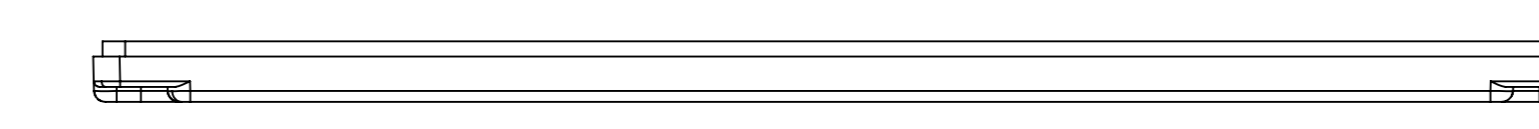

SURFACE-8

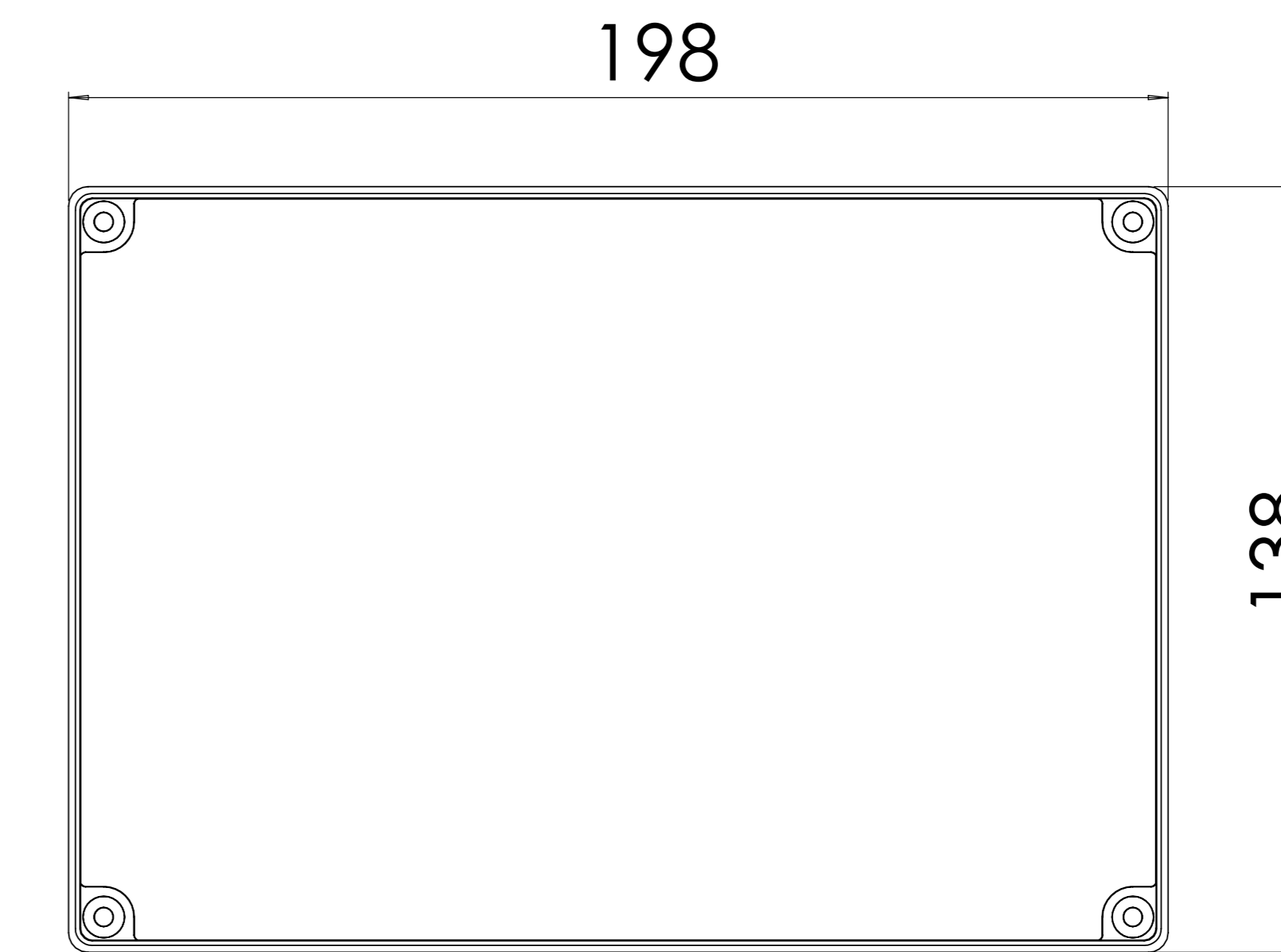

SURFACE-12 (INSIDE)

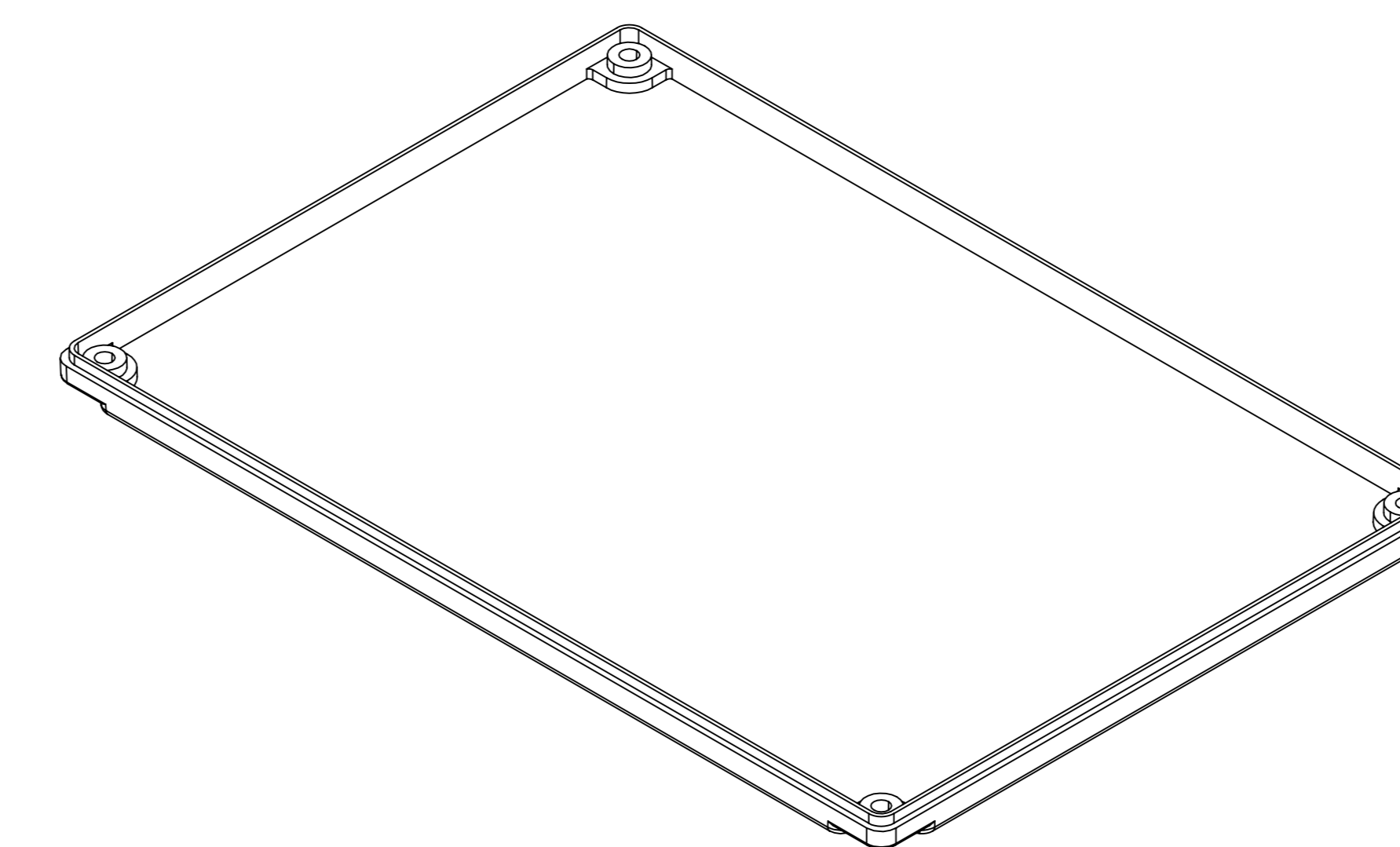

REV. NO	DATE	REVISED BY	DESCRIPTION OF CHANGE
 <b>ALTINKAYA</b> Electronic Enclosures & Components			
Customer Name :		Customer Ref. :	
Altinkaya Ref :		Part Name: OP-358-A	
DRAWN	NAME	DATE	Drawn From:
CHECKED	Y.YEL	6.11.2024	Material:
DIMENSIONAL TOLERANCES UNLESS OTHERWISE SPECIFIED (DIN7168)			Weight:
0.5-3mm	3-6mm	6-30mm	30-120mm
±0,1	±0,1	±0,2	±0,3
			120-400mm
			±0,5
			UNIT: mm
			Dimension(mm)
			m (medium)

# OP-358-A IF MACHINED TOGETHER

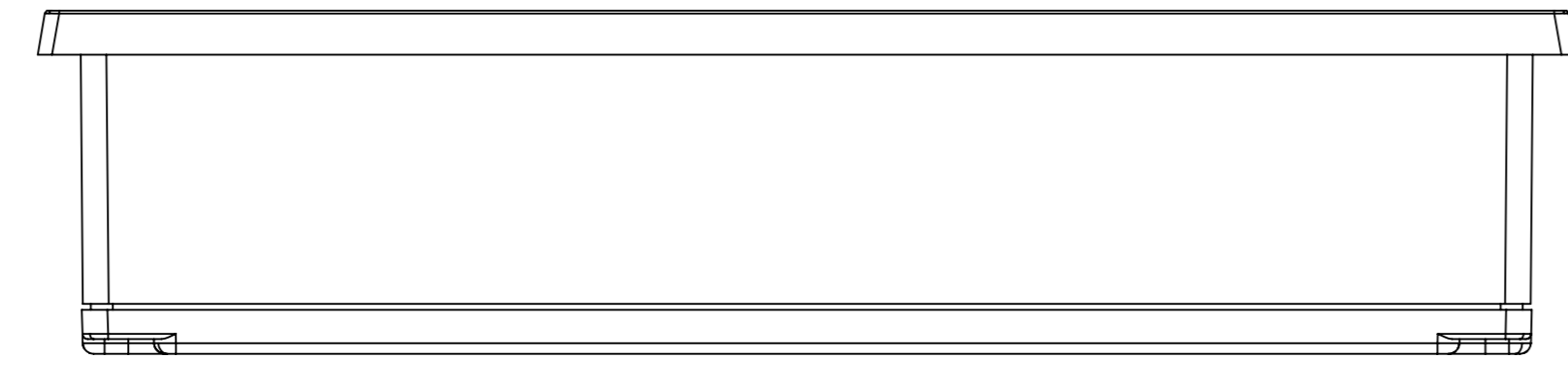

SURFACE-13

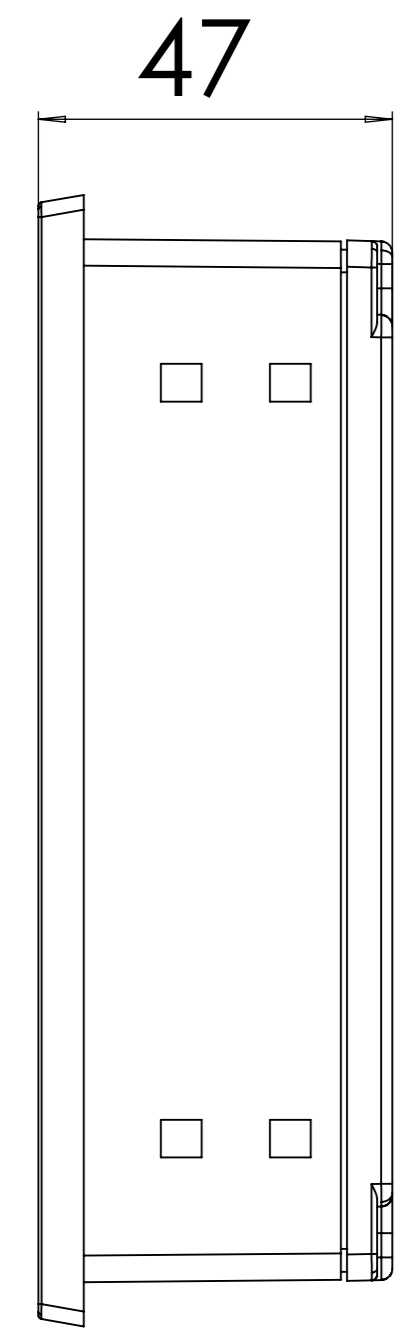

SURFACE-15

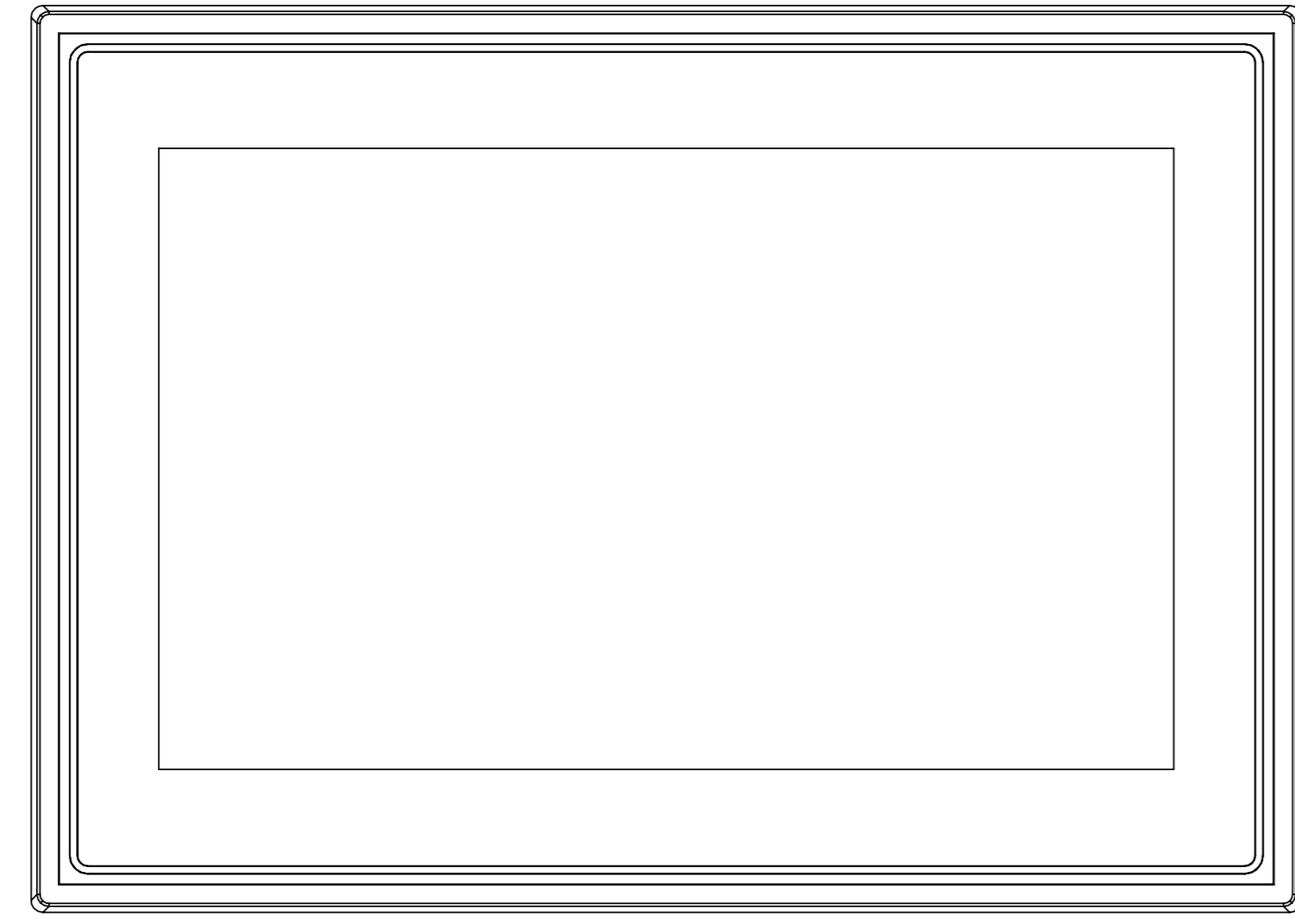

SURFACE-17

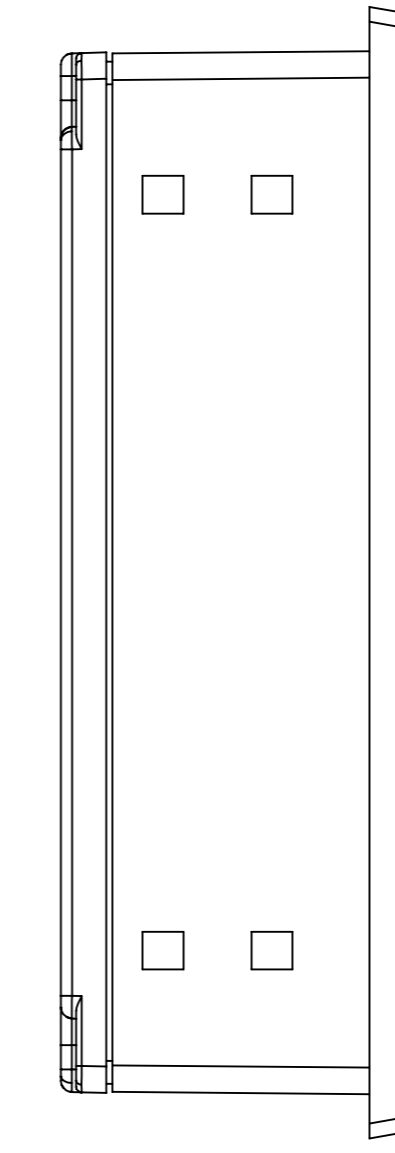

SURFACE-16

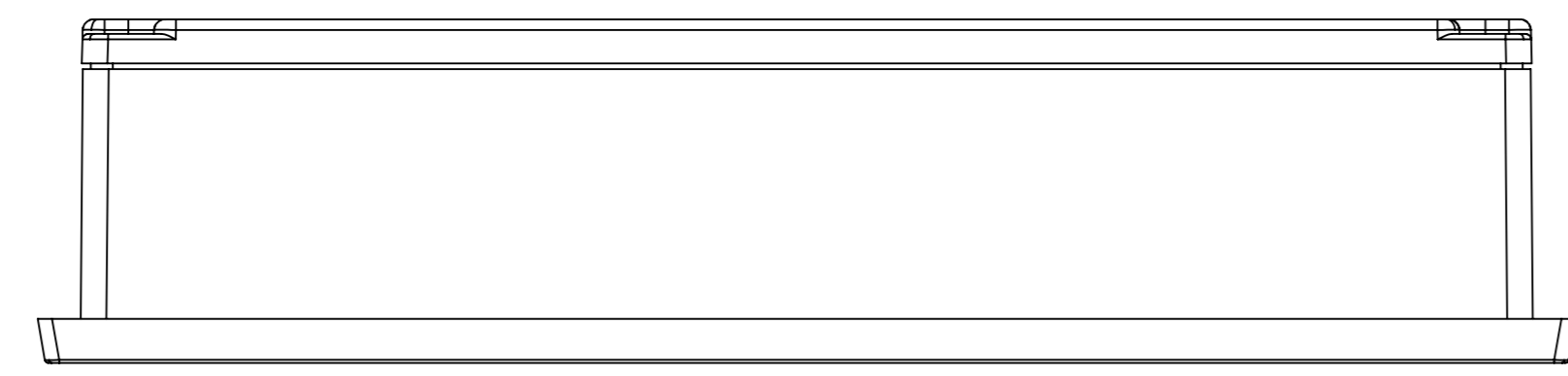

SURFACE-14

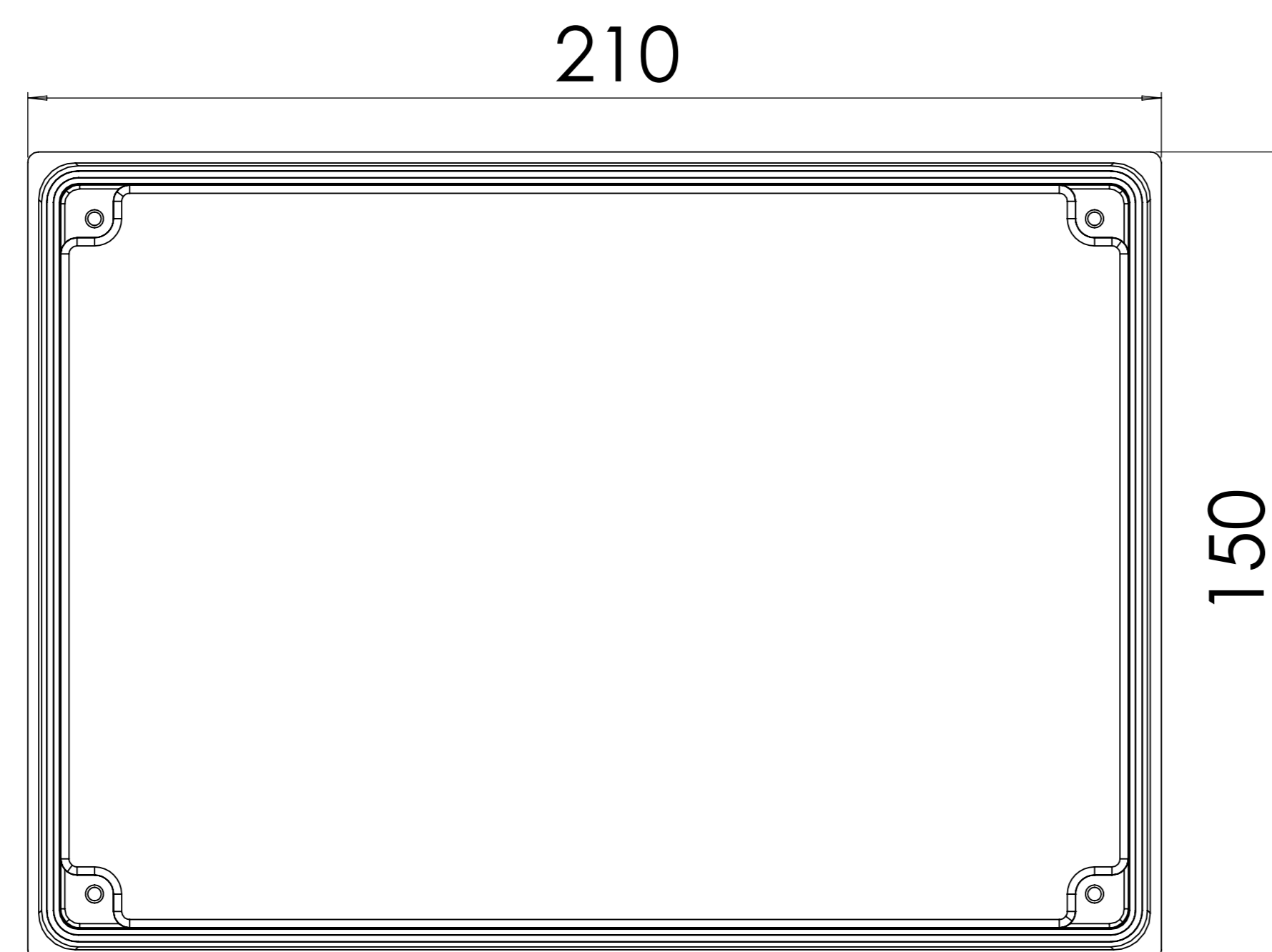

SURFACE-18

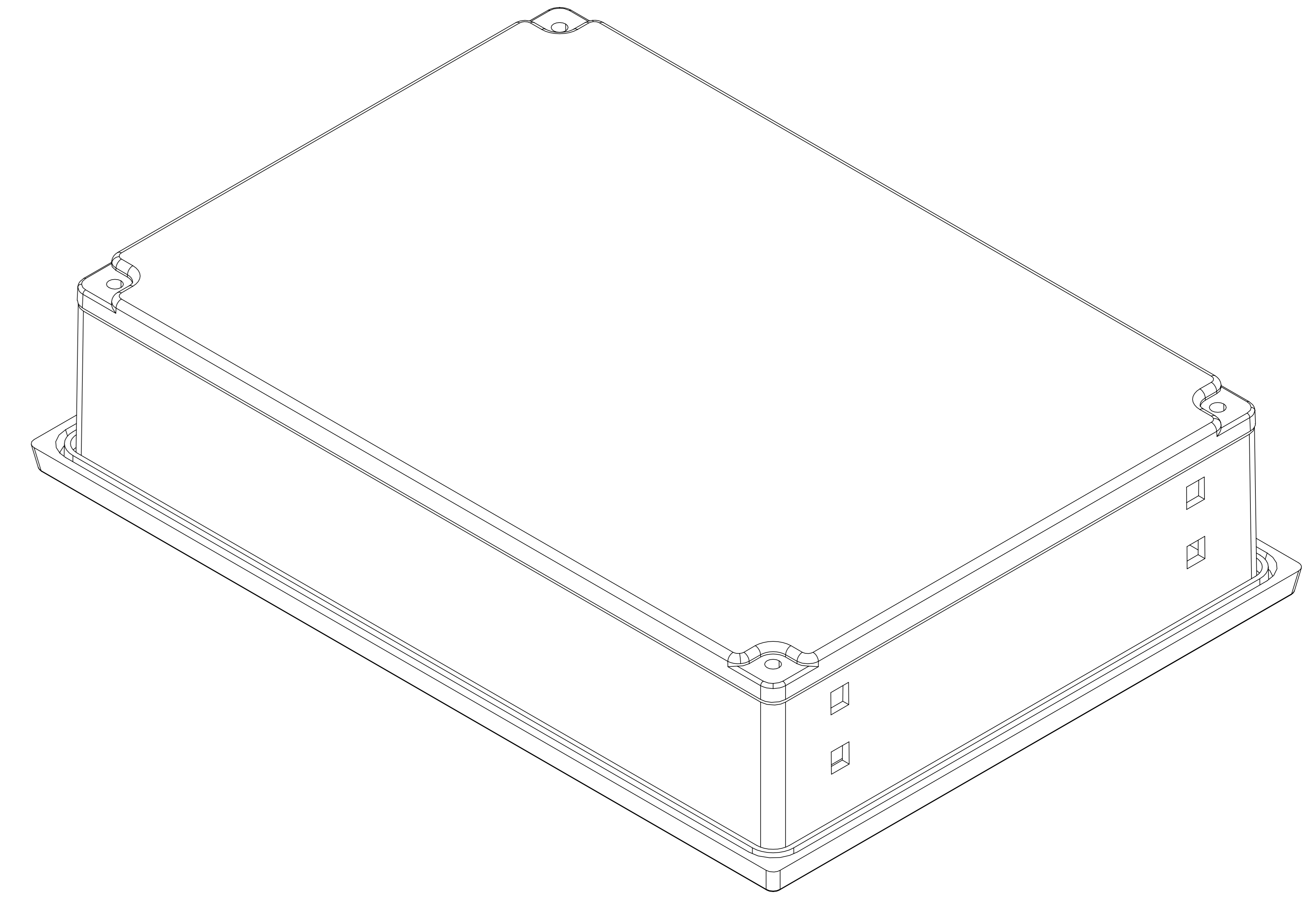
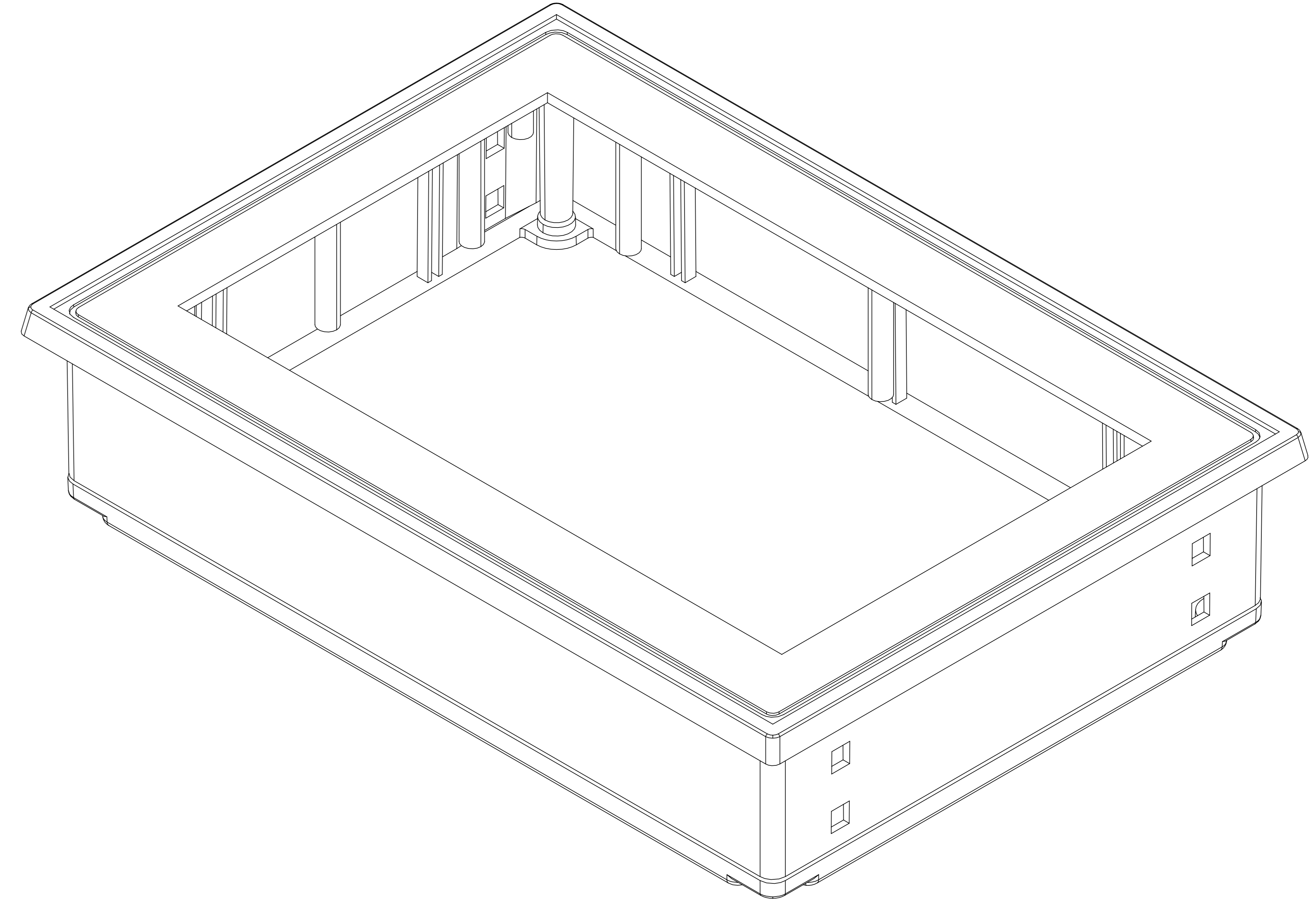

REV. NO	DATE	REVISED BY	DESCRIPTION OF CHANGE
<b>ALTINKAYA</b> Electronic Enclosures & Components			<a href="http://www.altinkaya.com">www.altinkaya.com</a>
Customer Name :		Customer Ref. :	
Altinkaya Ref :		Part Name: OP-358-A	
	NAME	DATE	Drawn From:
DRAWN	S.YESILOZ	6.11.2024	Material:
CHECKED	Y.YEL	6.11.2024	Weight:
DIMENSIONAL TOLERANCES UNLESS OTHERWISE SPECIFIED (DIN7168)			UNIT: mm
	0.5-3mm	3-6mm	6-30mm
	±0,1	±0,1	±0,2
			±0,3
			±0,5
			Dimension(mm)
			m (medium)