

BASE: 6 SURFACE

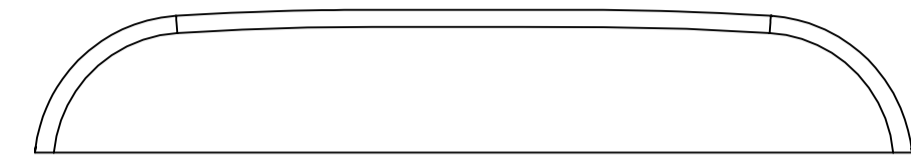

SURFACE-1

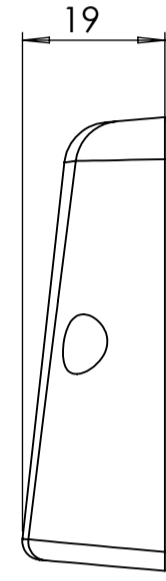

SURFACE-3

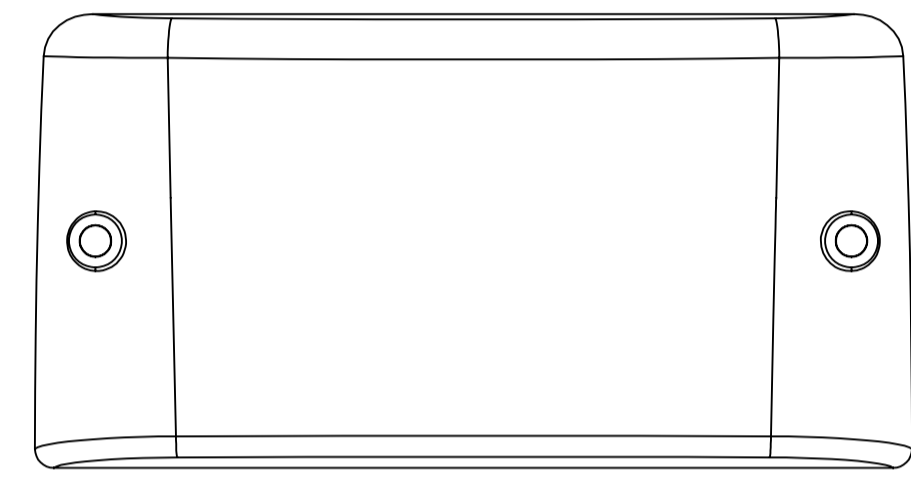

SURFACE-5

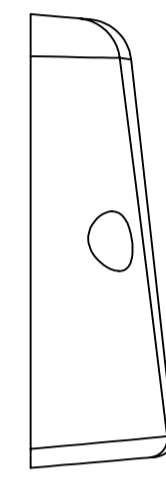

SURFACE-4

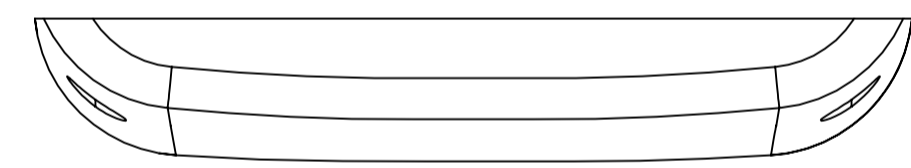

SURFACE-2

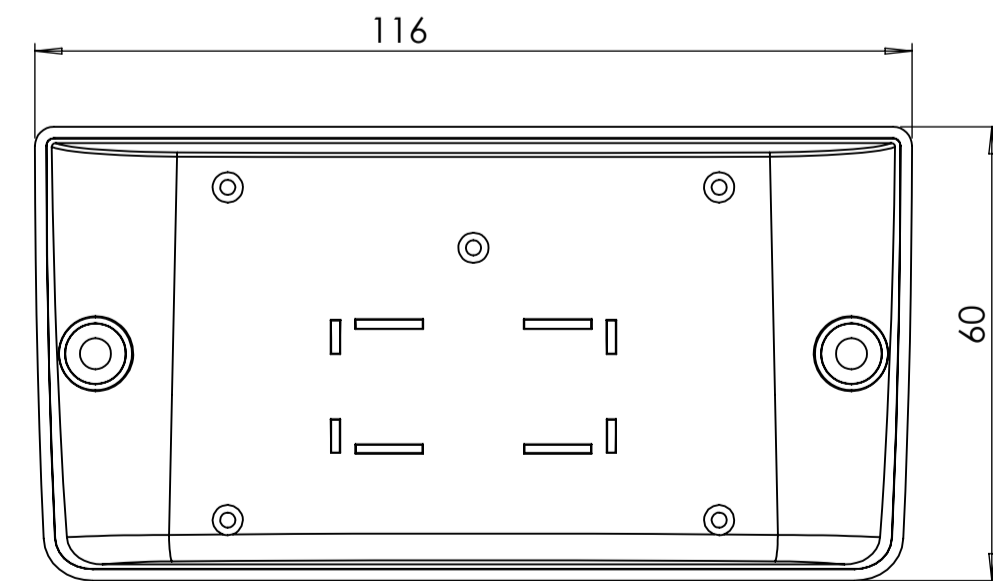
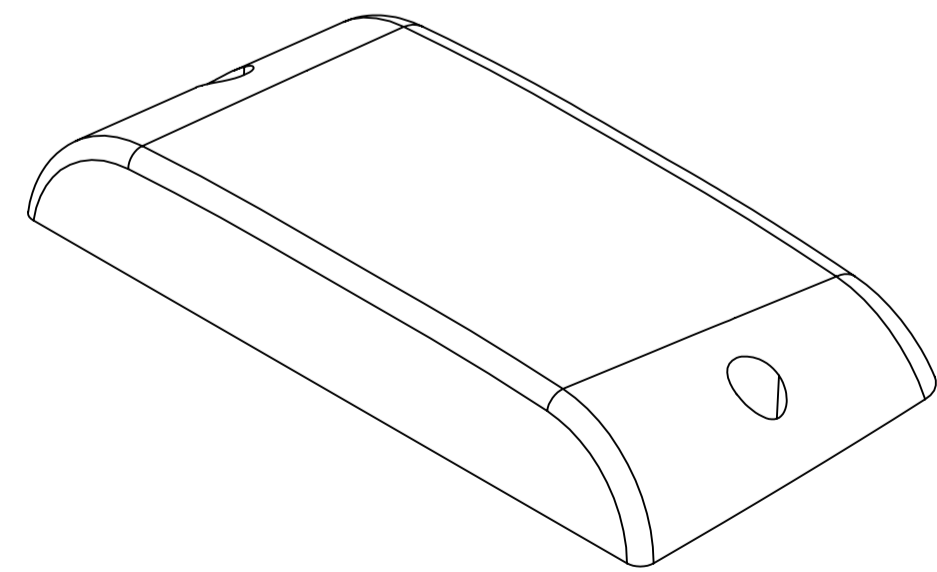

SURFACE-6 (INSIDE)

COVER: 6 SURFACE

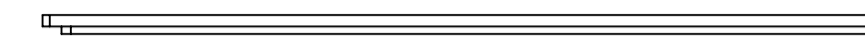

SURFACE-7

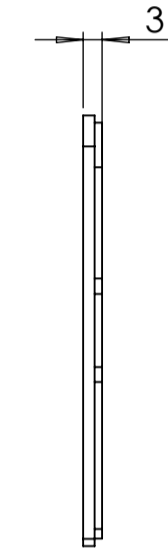

SURFACE-9

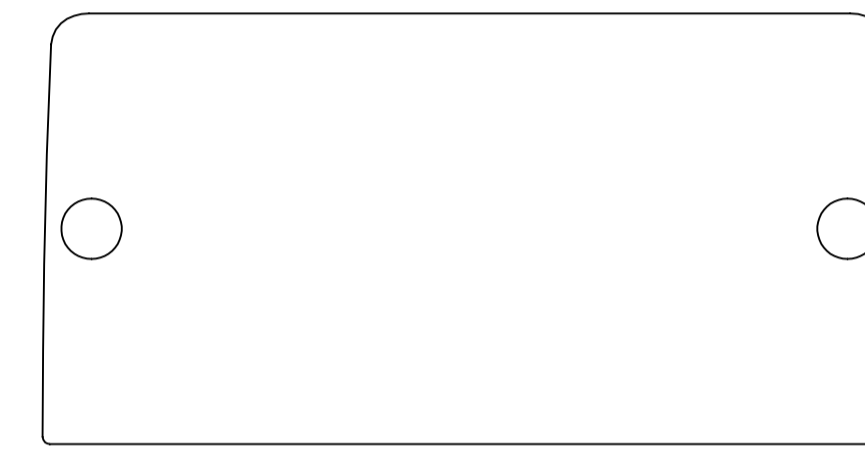

SURFACE-11



SURFACE-10



SURFACE-8

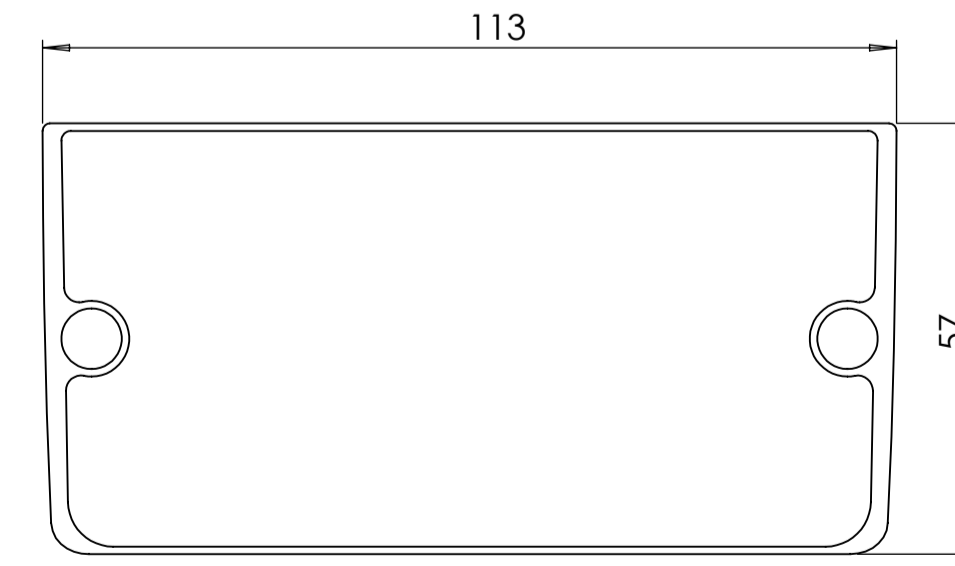
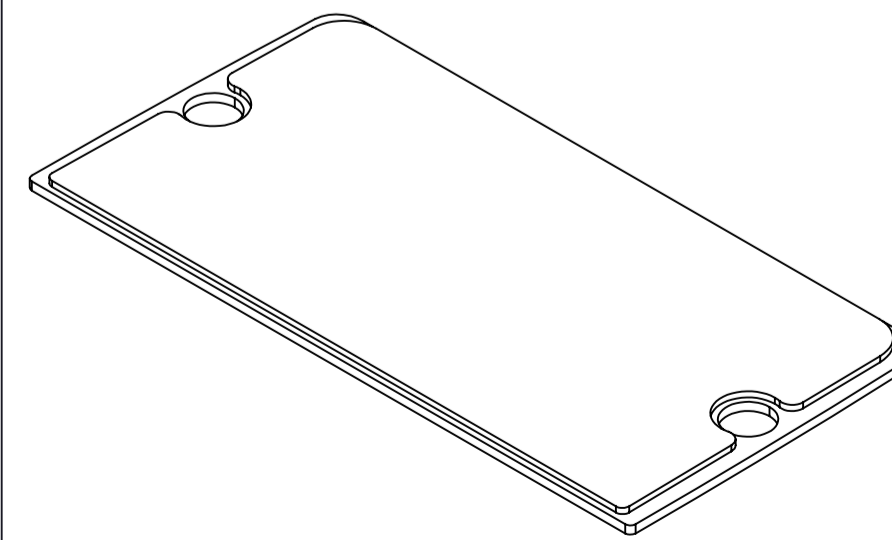

SURFACE-12 (INSIDE)

REV. NO.	DATE	REVISED BY	DESCRIPTION OF CHANGE
 ALTINKAYA Electronic Enclosures & Components www.altinkaya.com			
Customer Name:		Customer Ref.:	
Altinkaya Ref.:		Part Name: DM-040	
DRAWN	NAME	DATE	Material:
CHECKED	Y. YESLOZ	14.10.2024	Weight:
DIMENSIONAL TOLERANCES UNLESS OTHERWISE SPECIFIED:			SCALE 1:1 UNIT : mm
[DIN7148]	±0.1	±0.1	±0.2 ±0.3 ±0.5
	0.5-3mm	3-6mm	6-30mm 30-120mm 120-400mm
			Dimension(mm) m(medium)
			A1
			SHEET 1 OF 2

DM-040 IF MACHINED TOGETHER

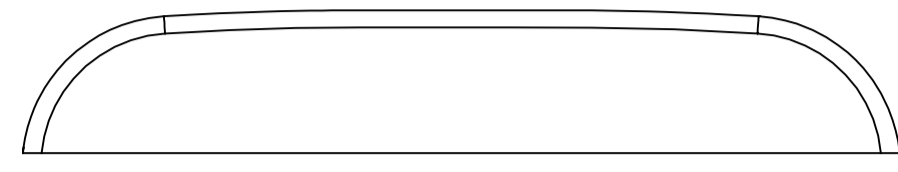

SURFACE-13

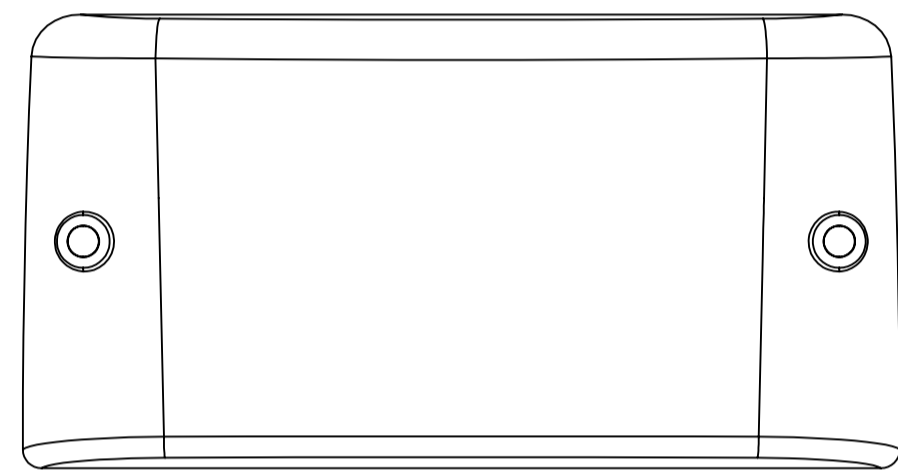

SURFACE-17

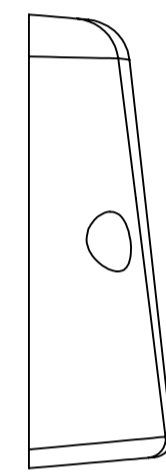

SURFACE-16

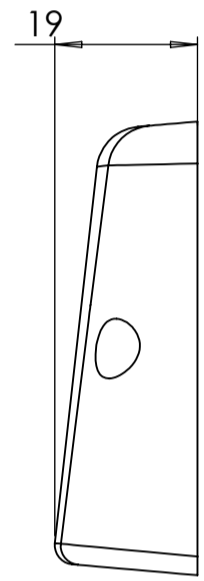

SURFACE-15

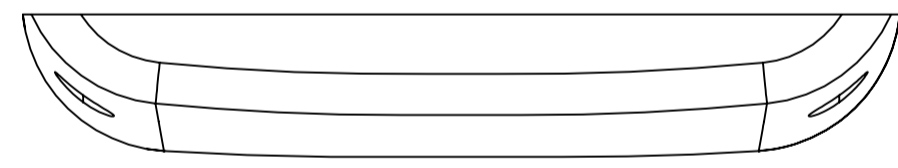

SURFACE-14

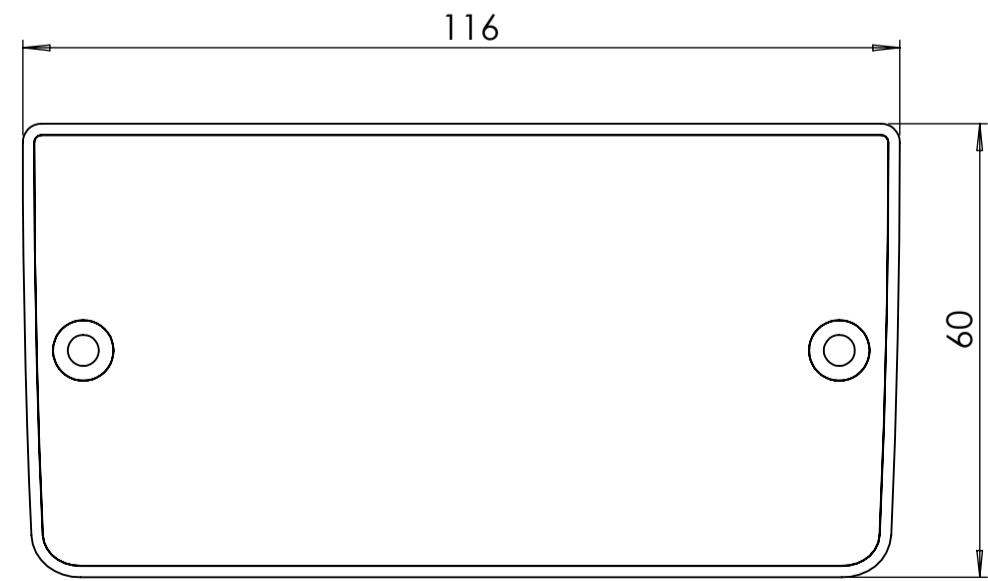

SURFACE-18

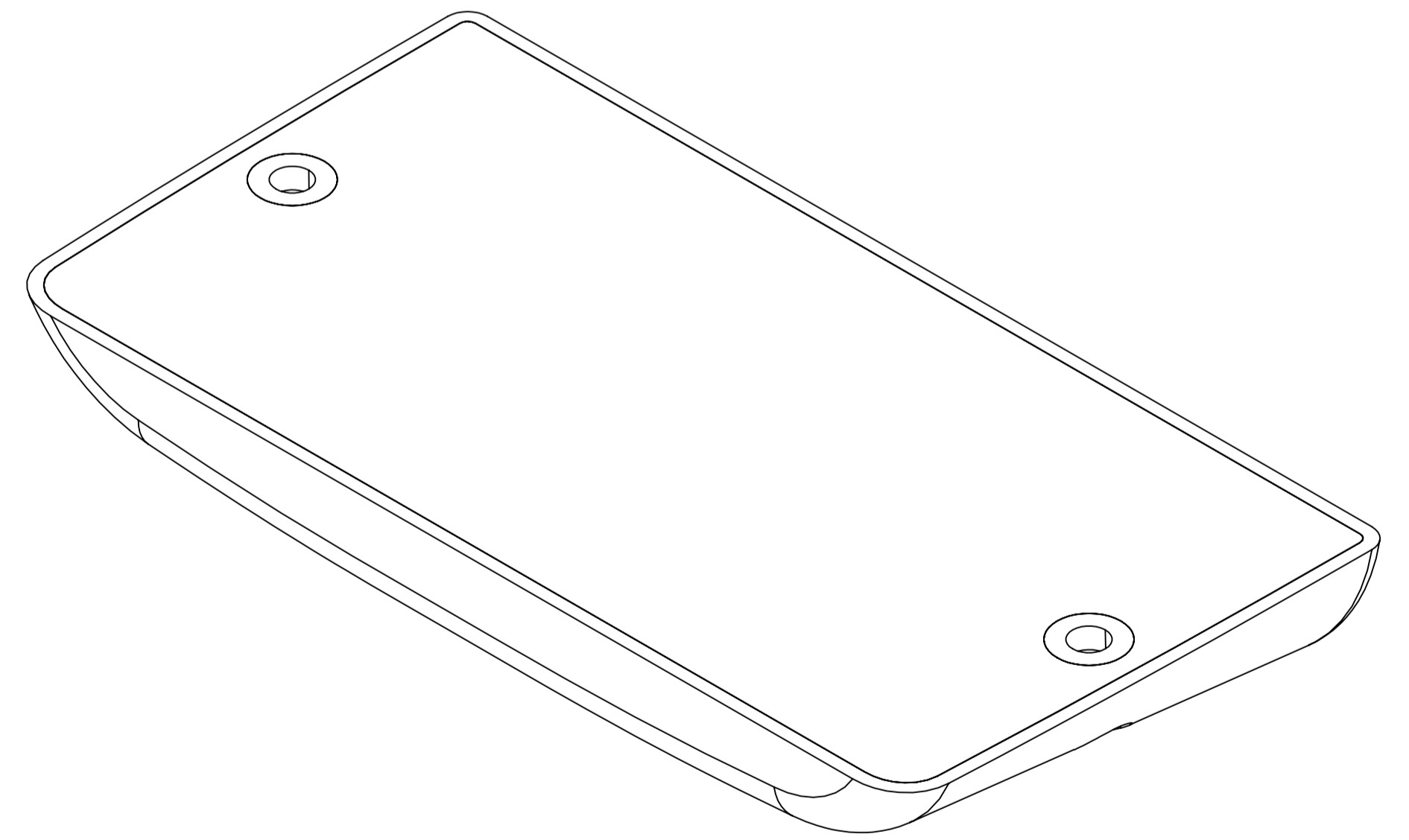
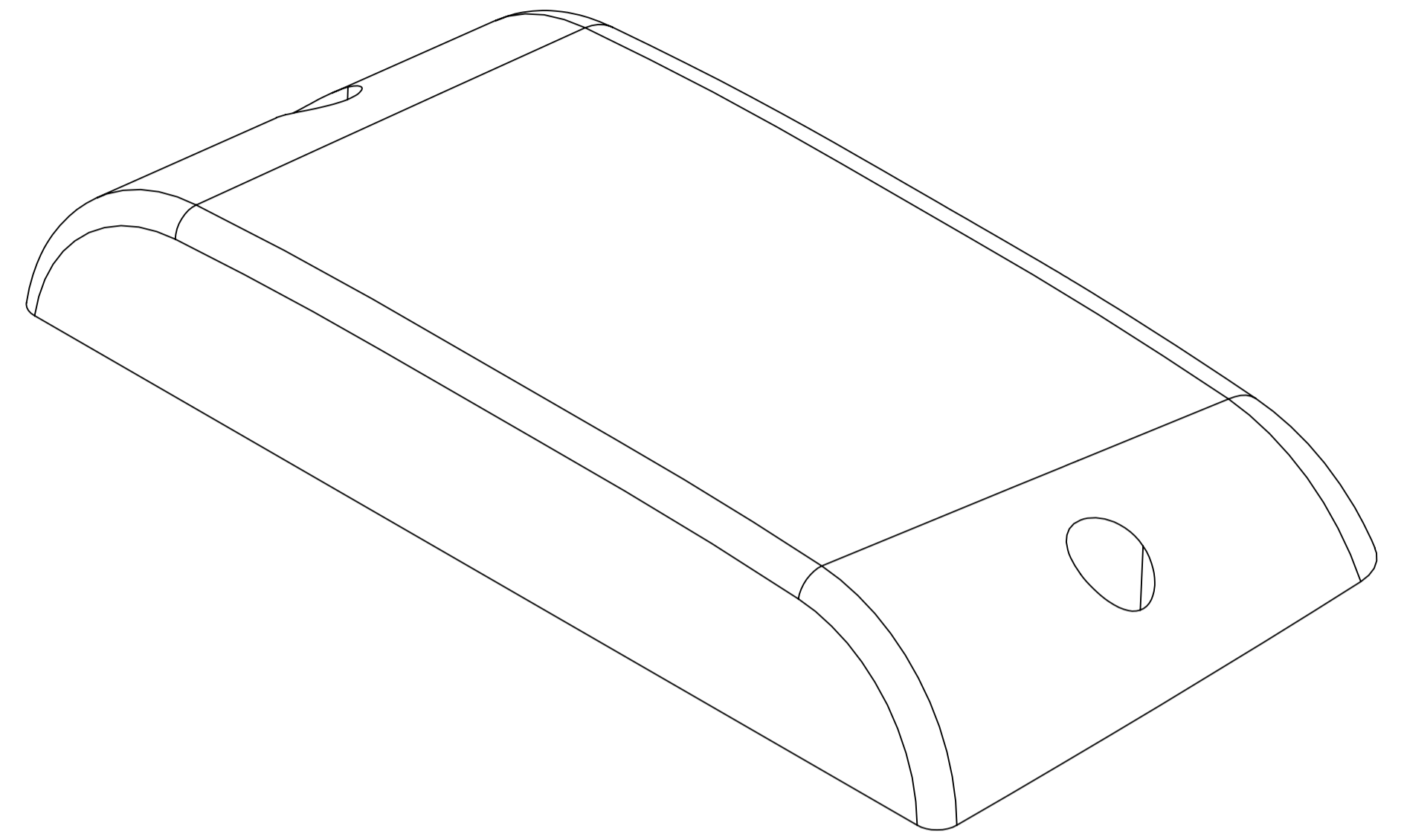

REV. NO.	DATE	REVISED BY	DESCRIPTION OF CHANGE
ALTINKAYA Electronic Enclosures & Components			
Customer Name:		Customer Ref.:	
Altinkaya Ref.:		Part Name: DM-040	
DRAWN	NAME	DATE	Material:
CHECKED	Y. YESLOZ	14.10.2024	Weight:
DIMENSIONAL TOLERANCES UNLESS OTHERWISE SPECIFIED:			SCALE 1:1 UNIT : mm
(DIN7148)	±0.1	±0.1	±0.3 ±0.5