

# BASE: 6 SURFACE

# COVER: 6 SURFACE

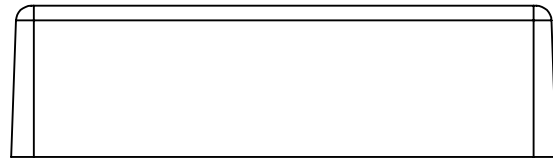

SURFACE-1

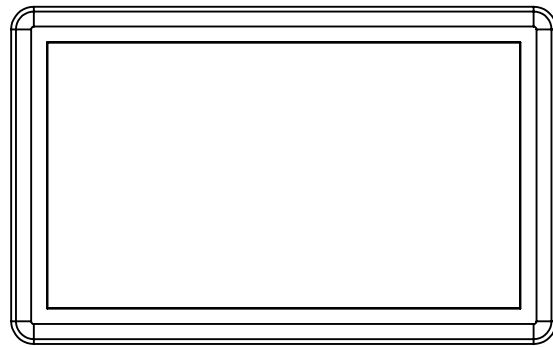

SURFACE-5

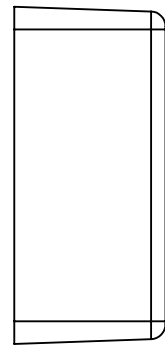

SURFACE-4

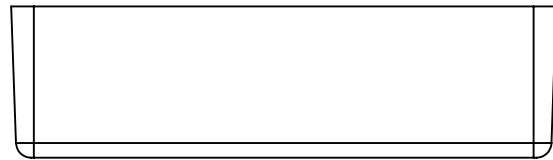

SURFACE-2

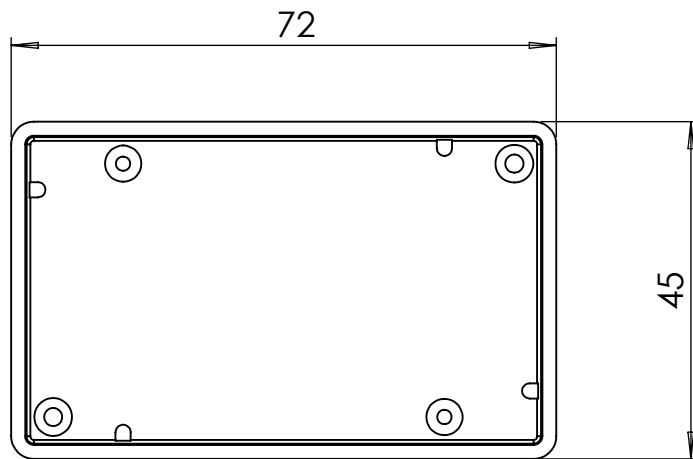

SURFACE-6 (INSIDE)

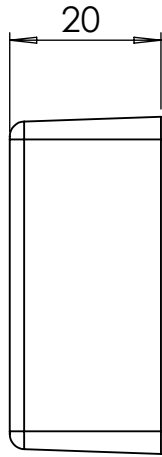

SURFACE-3

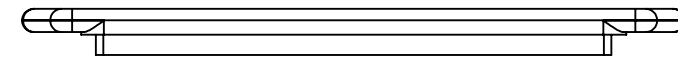
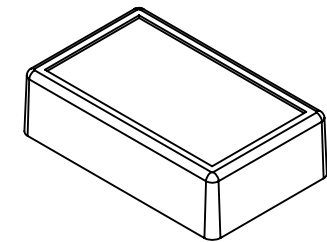

SURFACE-7

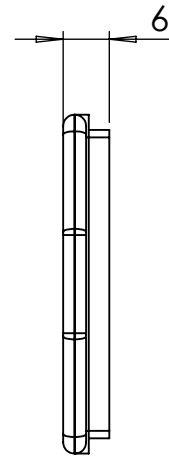

SURFACE-9

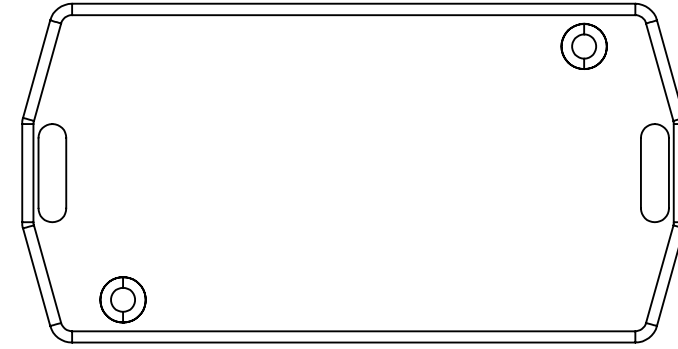

SURFACE-11

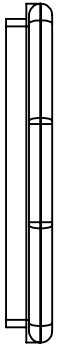

SURFACE-10

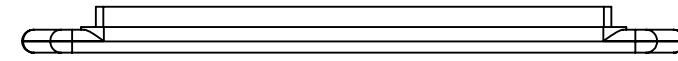

SURFACE-8

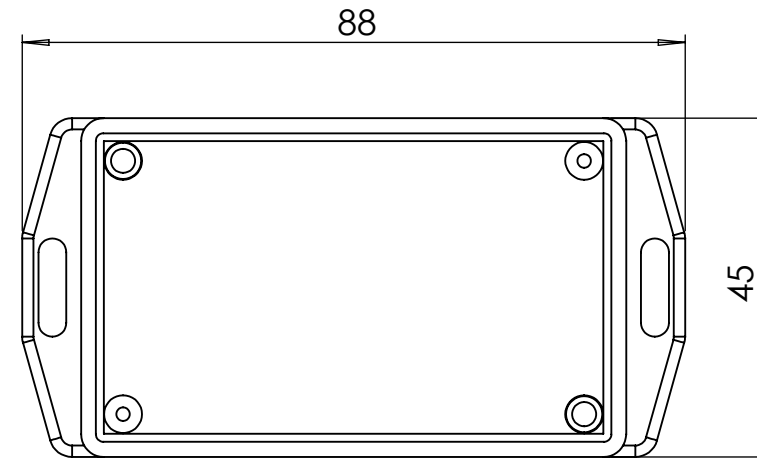

SURFACE-12 (INSIDE)

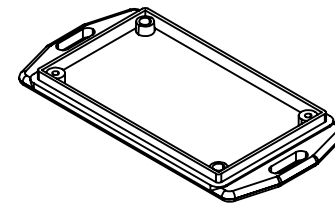

REV. NO	DATE	REVISED BY	DESCRIPTION OF CHANGE		
			<a href="http://www.altinkaya.com">www.altinkaya.com</a>		
Customer Name:		Customer Ref:			
Altinkaya Ref:		Part Name : DM-014			
DRAWN	NAME	DATE	Drawn From:		
S. YESILOZ	Y. YEL	19.09.2024	Material :		
CHECKED	NAME	DATE	Weight:	g	UNIT : mm
Y. YEL	19.09.2024		0,5-3mm	3-6 mm	6-30mm
DIMENSIONAL TOLERANCES UNLESS OTHERWISE SPECIFIED (DIN7168)			±0,1	±0,1	±0,2
			±0,3	±0,5	±0,5
			Dimension (mm)		
			m (medium)		
			SCALE:1:1		
			SHEET 1 OF 2		

A3

# DM-014 IF MACHINED TOGETHER

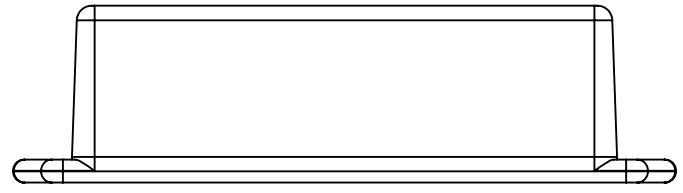

SURFACE-13

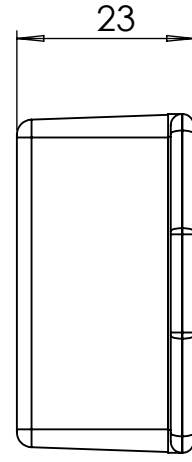

SURFACE-15

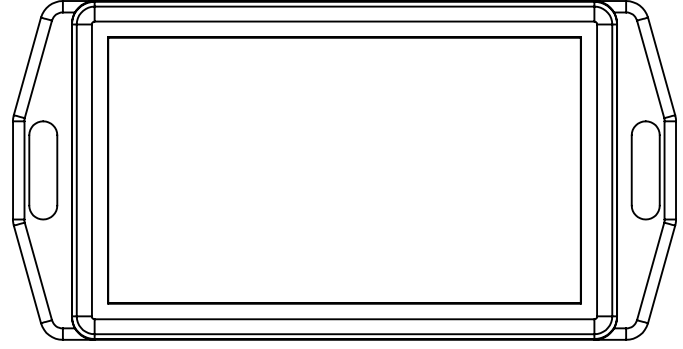

SURFACE-17

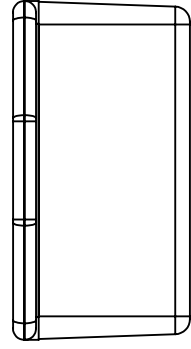

SURFACE-16

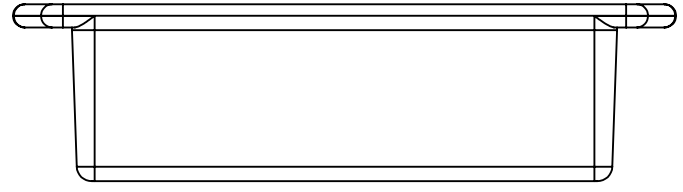
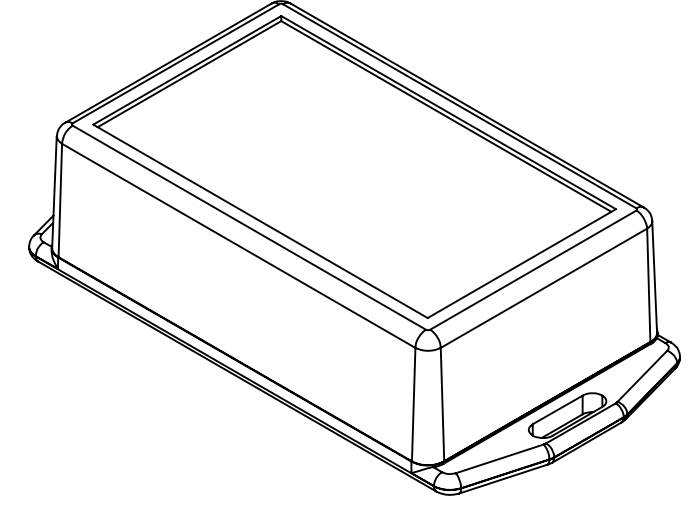

SURFACE-14

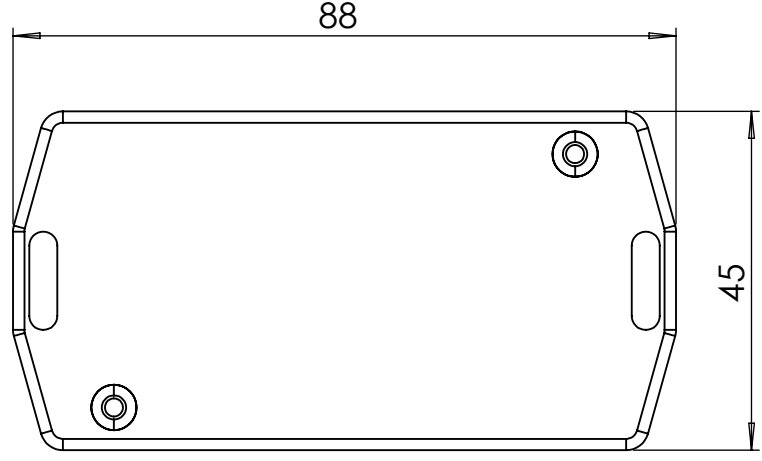

SURFACE-18

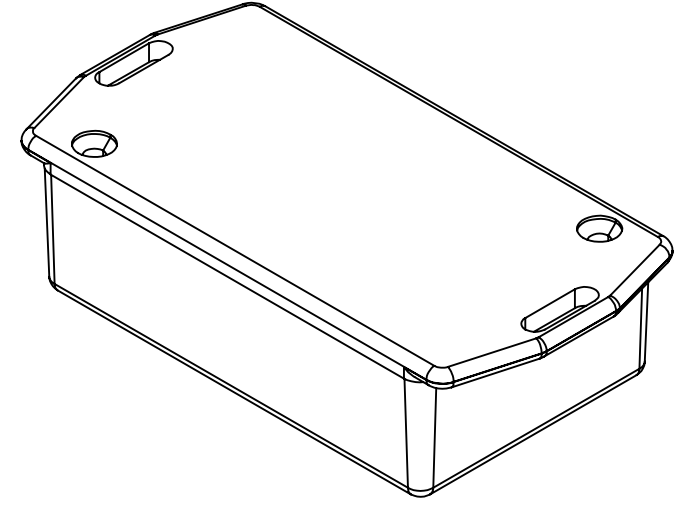

REV. NO	DATE	REVISED BY	DESCRIPTION OF CHANGE		
<b>ALTINKAYA</b> Electronic Enclosures & Components			<a href="http://www.altinkaya.com">www.altinkaya.com</a>		
Customer Name:		Customer Ref:			
Altinkaya Ref :		Part Name : DM-014			
DRAWN		NAME		DATE	
CHECKED		Y. YEL		19.09.2024	
Material :		Weight:		g	
DIMENSIONAL TOLERANCES UNLESS OTHERWISE SPECIFIED (DIN7168)		0,5-3mm	3-6 mm	6-30mm	30-120mm
		±0,1	±0,1	±0,2	±0,3
					120-400mm
					±0,5
					Dimension (mm)
					m (medium)
					UNIT : mm
					A3
					SCALE:1:1
					SHEET 2 OF 2