

# BASE: 6 SURFACE

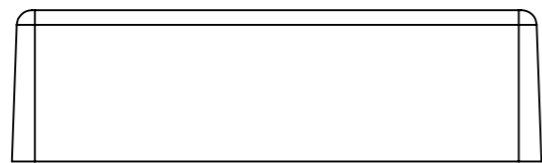

SURFACE-1

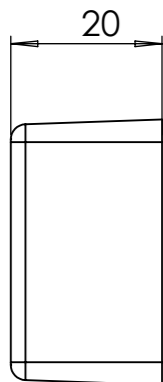

SURFACE-3

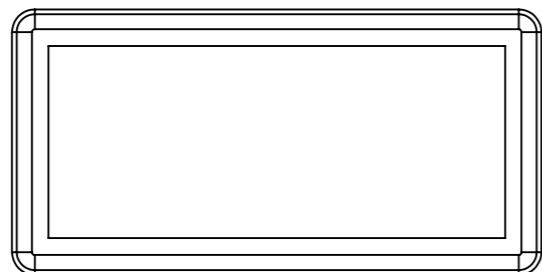

SURFACE-5

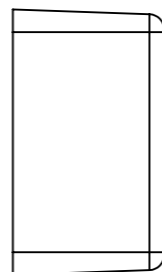

SURFACE-4

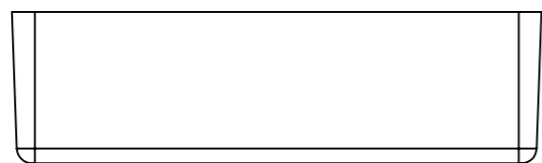

SURFACE-2

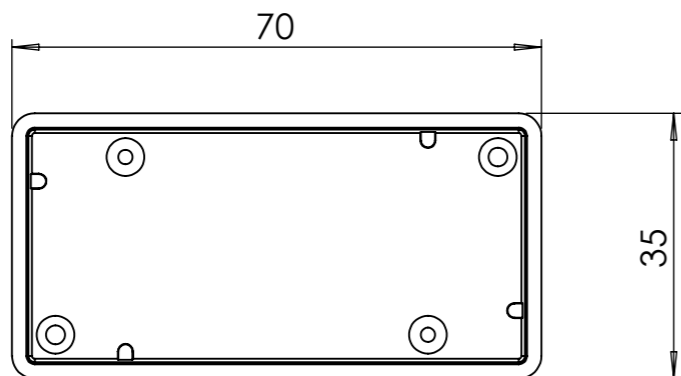

SURFACE-6 (INSIDE)

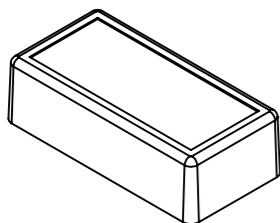

# COVER: 6 SURFACE

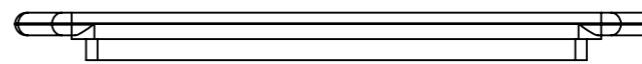

SURFACE-7

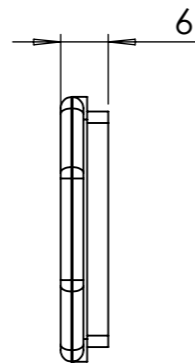

SURFACE-9

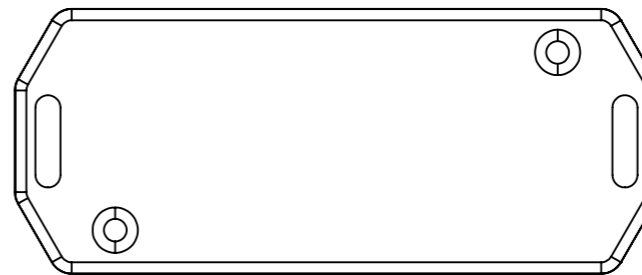

SURFACE-11



SURFACE-10

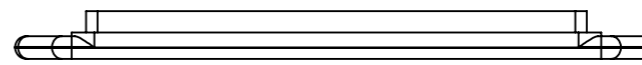

SURFACE-8

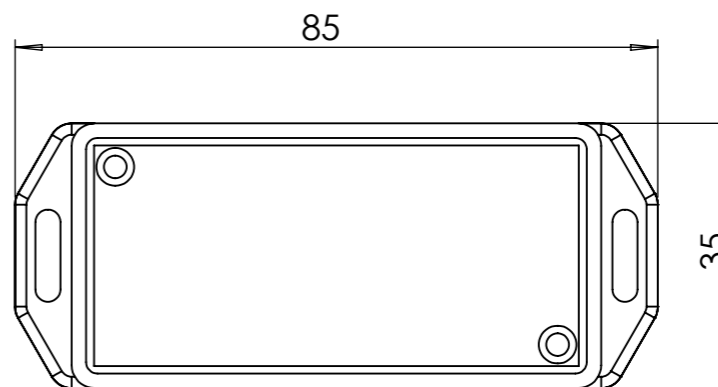

SURFACE-12 (INSIDE)

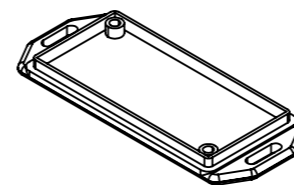

REV. NO	DATE	REVISED BY	DESCRIPTION OF CHANGE					
			<b>ALTINKAYA</b> Electronic Enclosures & Components					
			<a href="http://www.altinkaya.com">www.altinkaya.com</a>					
Customer Name:			Customer Ref:					
Altinkaya Ref :			Part Name : DM-009					
NAME			DATE					
DRAWN S. YESILOZ			19.09.2024					
CHECKED Y. YEL			19.09.2024					
Material :			Weight: g					
DIMENSIONAL TOLERANCES UNLESS OTHERWISE SPECIFIED (DIN7168)			0,5-3mm	3-6 mm	6-30mm	30-120mm	120-400mm	Dimension (mm)
			±0,1	±0,1	±0,2	±0,3	±0,5	m (medium)
			SCALE:1:1			SHEET 1 OF 2		

A3

# DM-009 IF MACHINED TOGETHER

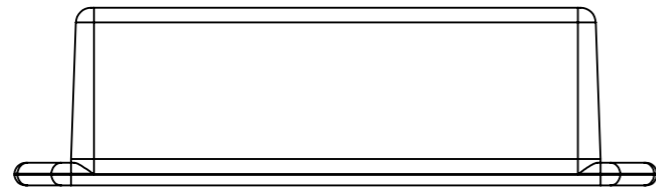

SURFACE-13

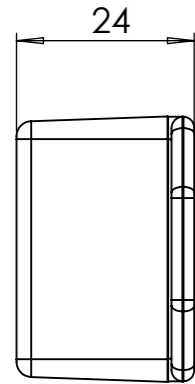

SURFACE-15

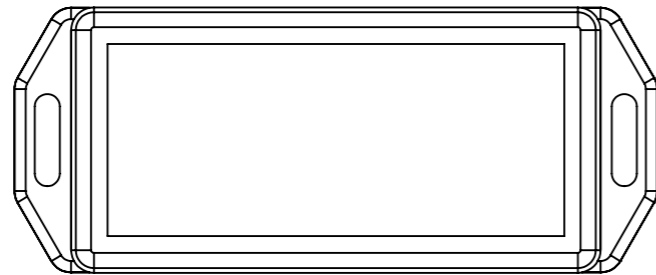

SURFACE-17

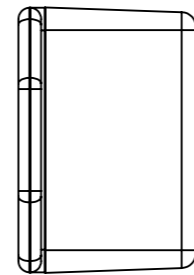

SURFACE-16

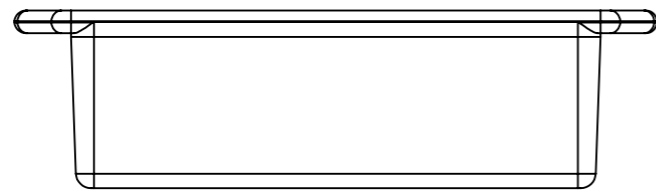
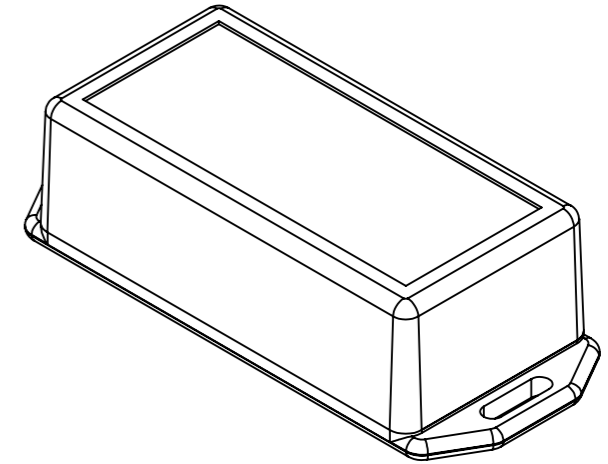

SURFACE-14

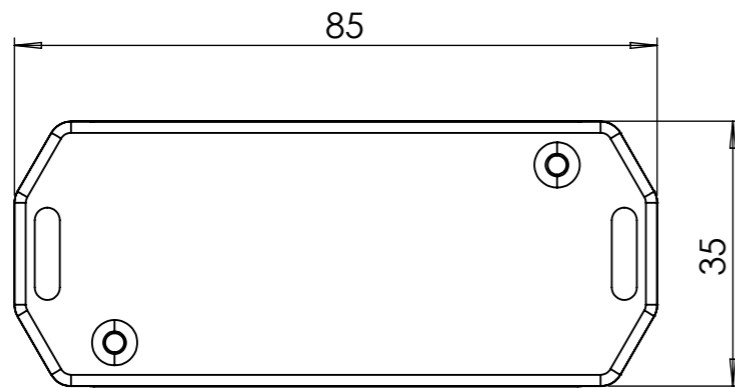

SURFACE-18

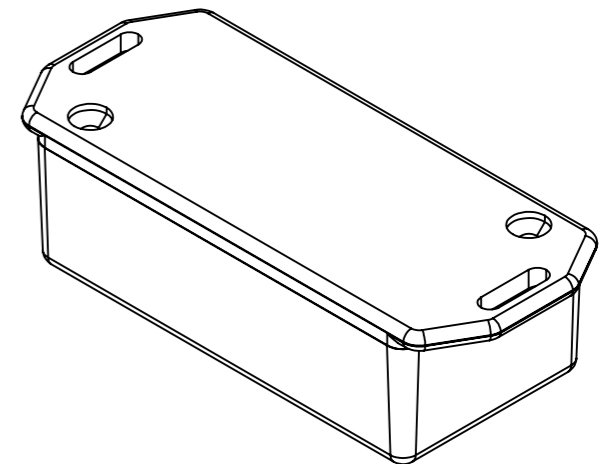

REV. NO	DATE	REVISED BY	DESCRIPTION OF CHANGE					
<b>ALTINKAYA</b>			<a href="http://www.altinkaya.com">www.altinkaya.com</a>					
Electronic Enclosures & Components								
Customer Name:			Customer Ref:					
Altinkaya Ref :			Part Name : DM-009					
NAME		DATE	Drawn From:					
DRAWN	S. YESILOZ	19.09.2024	Material :					
CHECKED	Y. YEL	19.09.2024	Weight:	g	UNIT : mm			
DIMENSIONAL TOLERANCES UNLESS OTHERWISE SPECIFIED (DIN7168)			0,5-3mm	3-6 mm	6-30mm	30-120mm	120-400mm	Dimension (mm)
			±0,1	±0,1	±0,2	±0,3	±0,5	m (medium)
SCALE:1:1 SHEET 2 OF 2								

A3