

BASE: 6 SURFACE

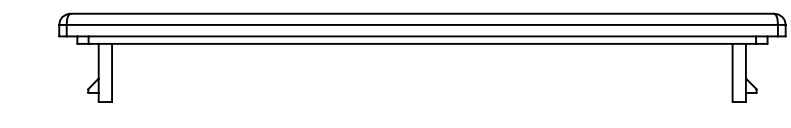

SURFACE-1

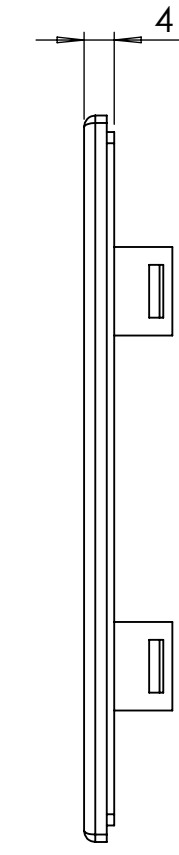

SURFACE-3

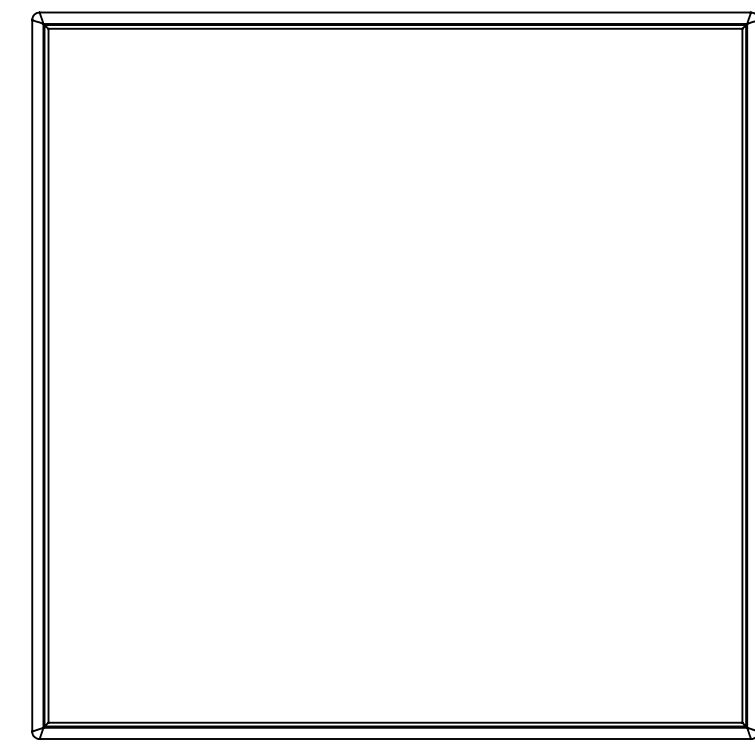

SURFACE-5



SURFACE-4

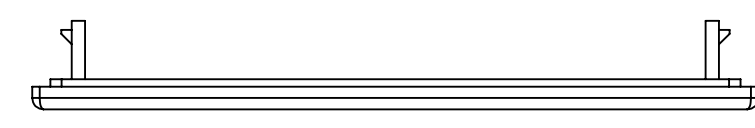

SURFACE-2

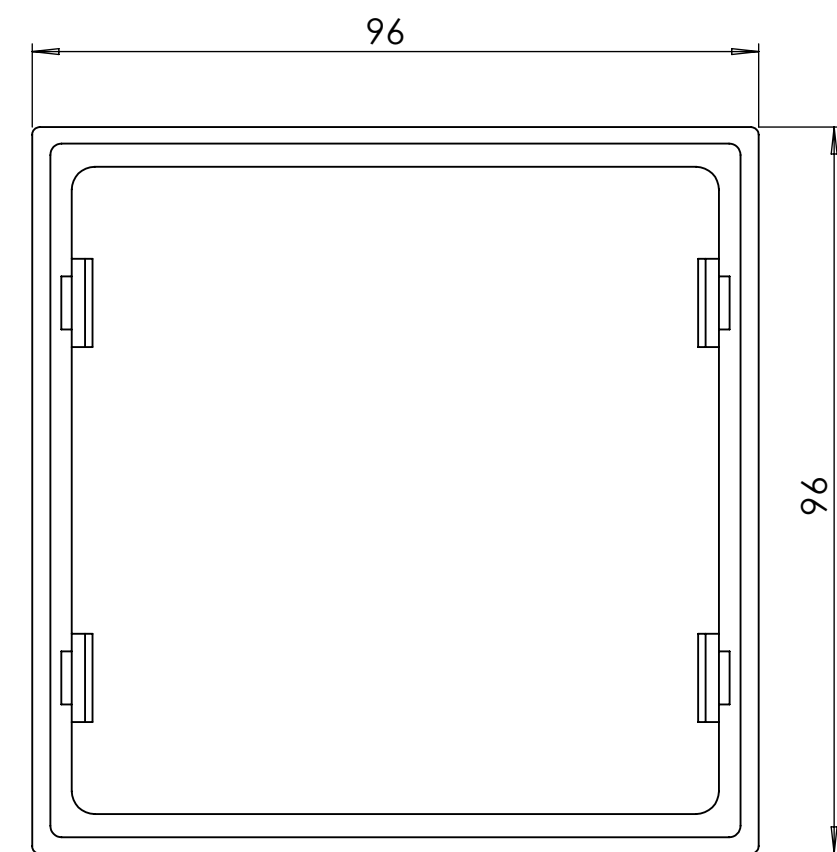

SURFACE-6 (INSIDE)

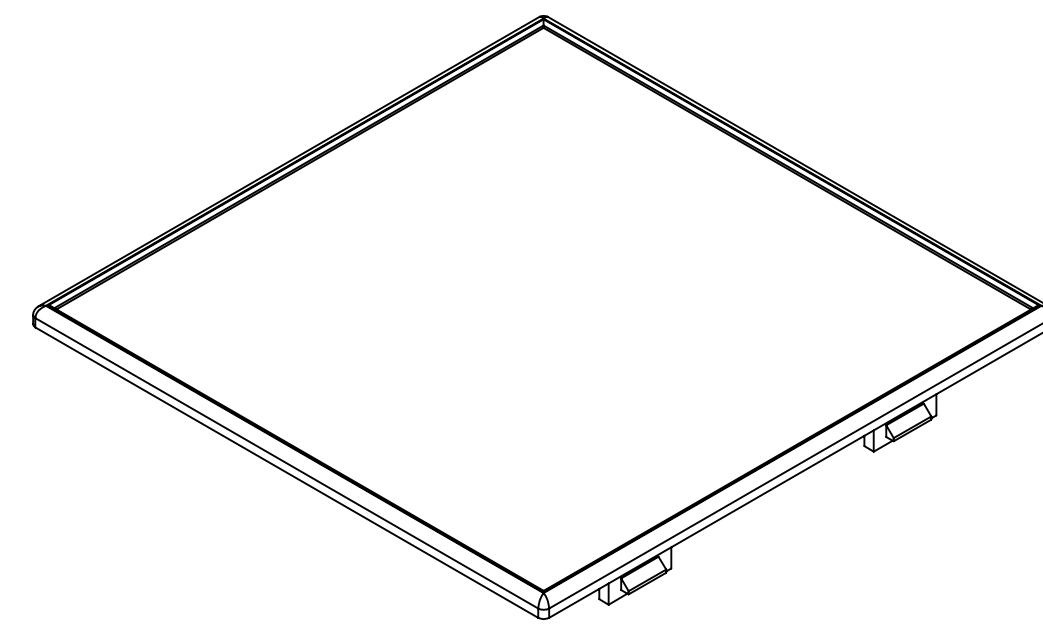

COVER: 6 SURFACE

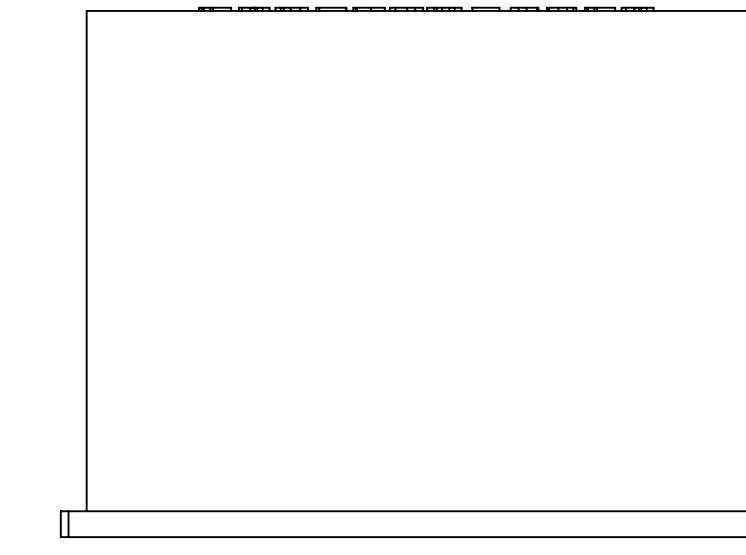

SURFACE-7

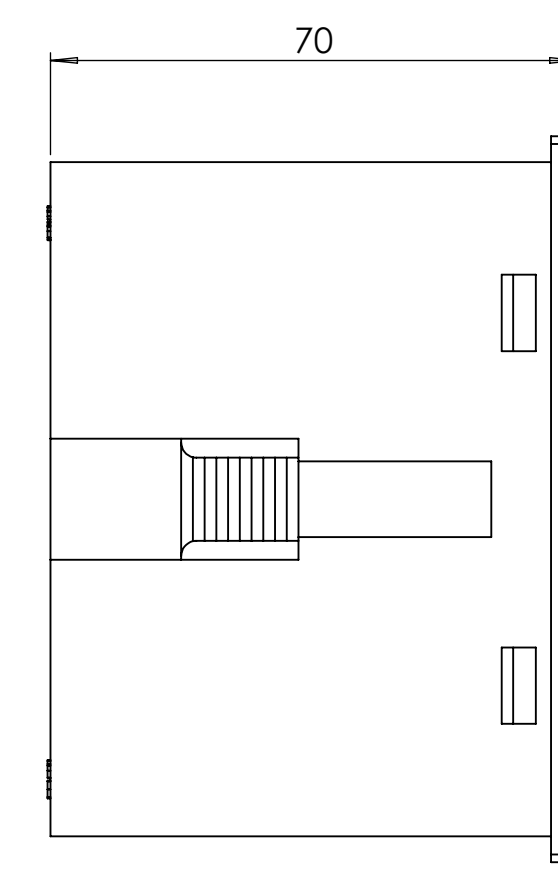

SURFACE-9

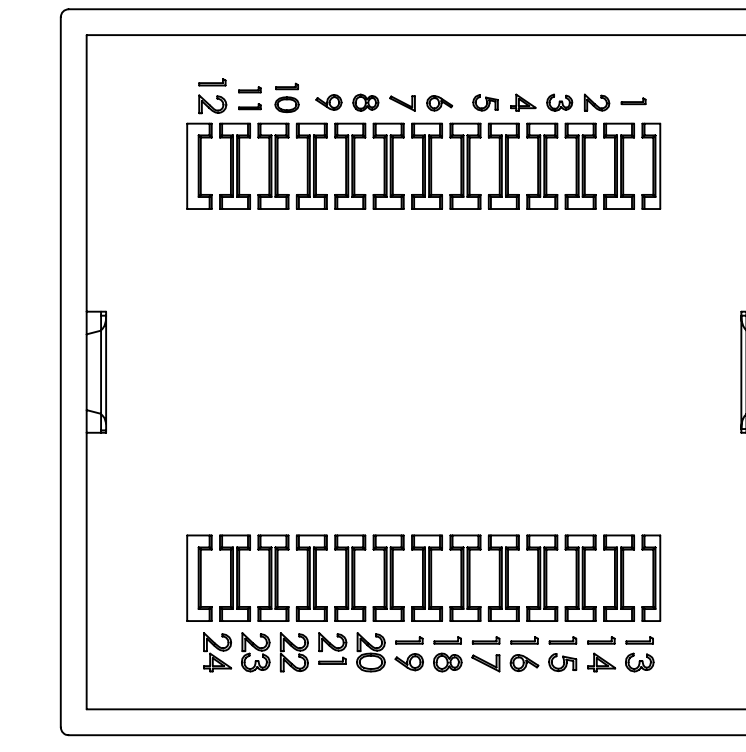

SURFACE-11

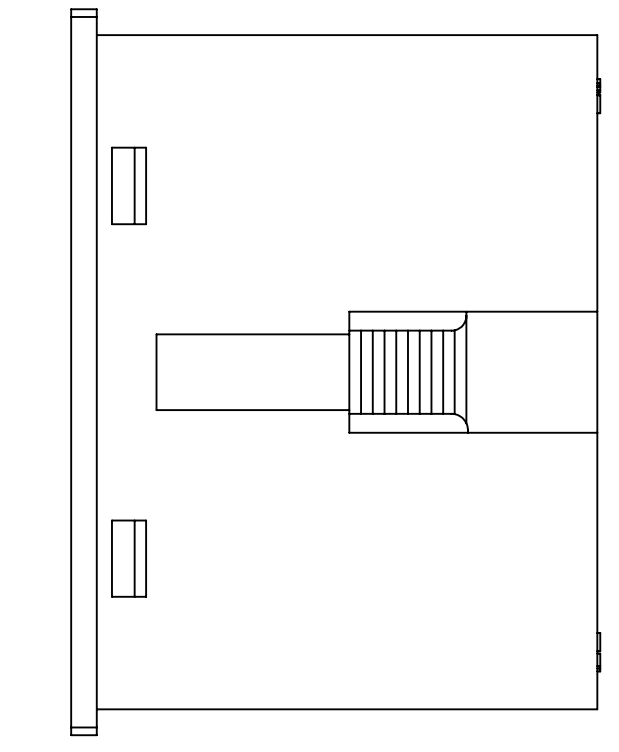

SURFACE-10

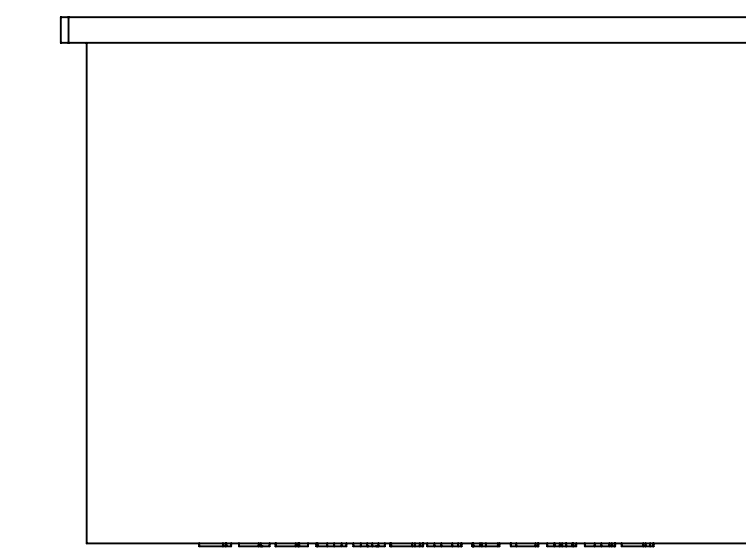

SURFACE-8

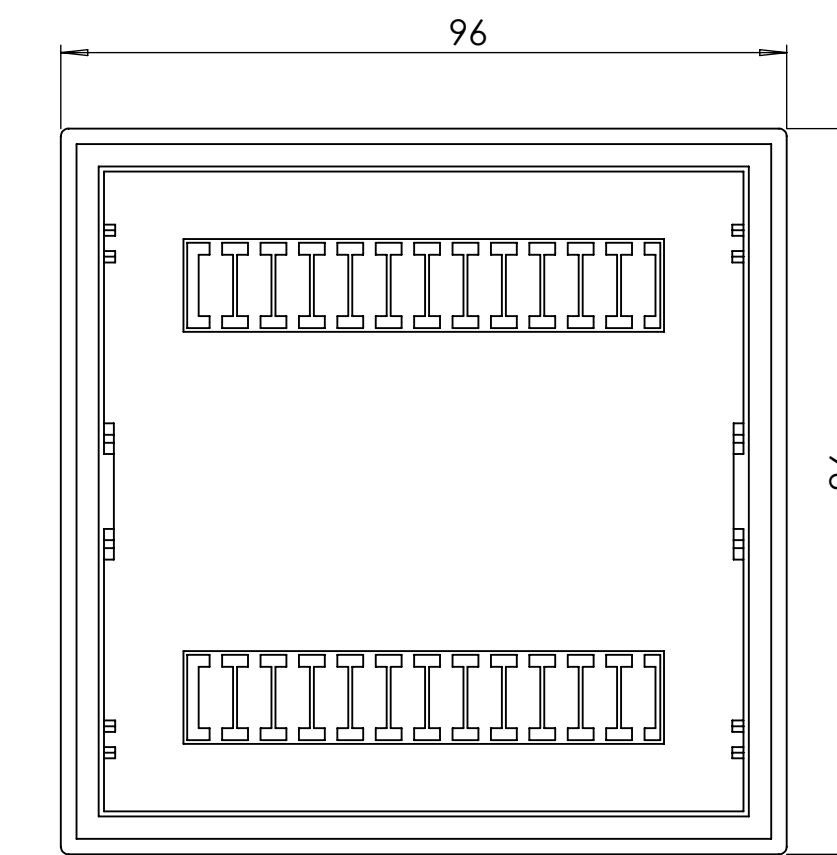

SURFACE-12 (INSIDE)

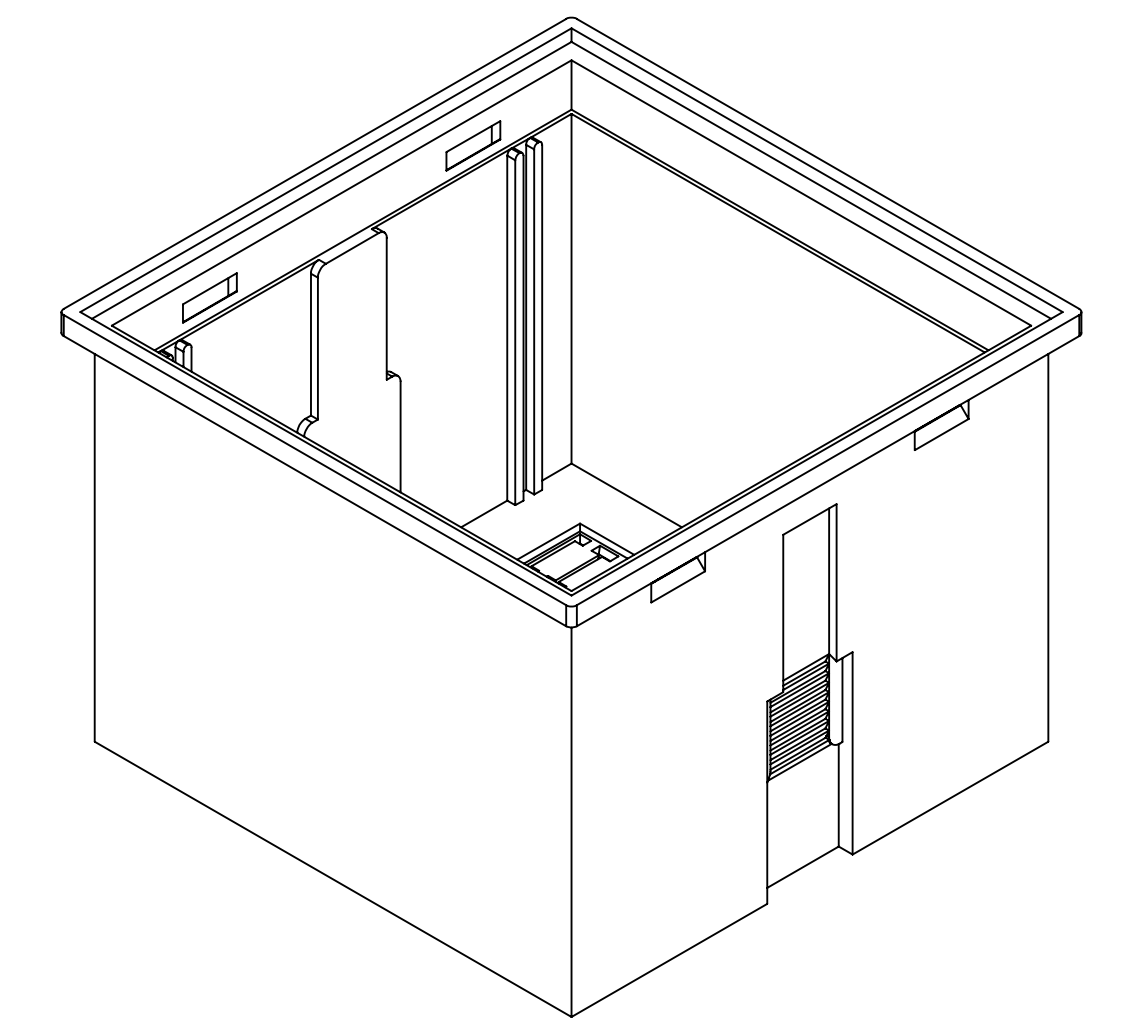

REV. NO	DATE	REVISED BY	DESCRIPTION OF CHANGE
ALTINKAYA Electronic Enclosures & Components			www.altinkaya.com
Customer Name:		Customer Ref.:	
Altinkaya Ref.:		Part Name: PT-220-01	
DRAWN	NAME	DATE	Drawn From:
CHECKED	Y.YEL	7.10.2024	Weight:
DIMENSIONAL TOLERANCES UNLESS OTHERWISE SPECIFIED (DIN7168)			
	0.5-3mm	3-6mm	6-30mm
	±0.1	±0.1	±0.2
			±0.3
			±0.5
			m (Medium)
SCALE 1:1			SHEET 1 OF 2
UNIT: mm			A0

PT-220 IF MACHINED TOGETHER



SURFACE-13

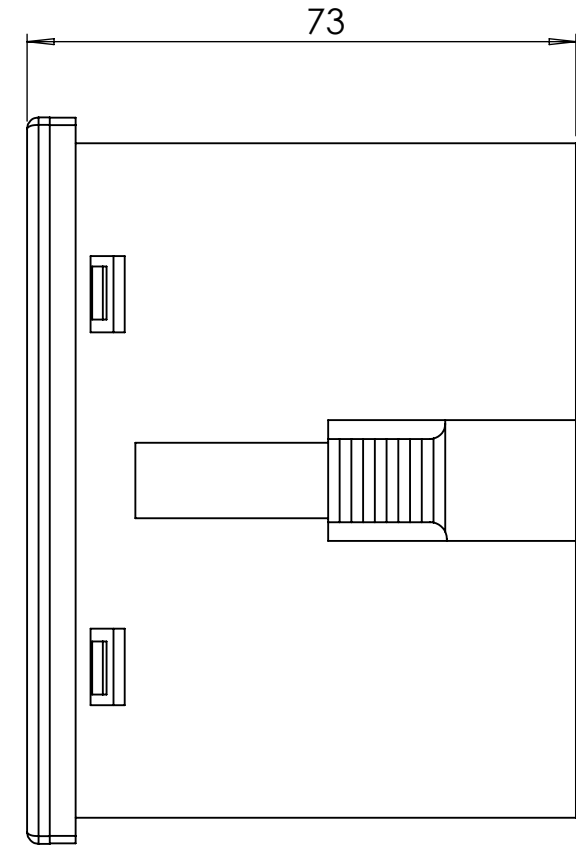

SURFACE-15

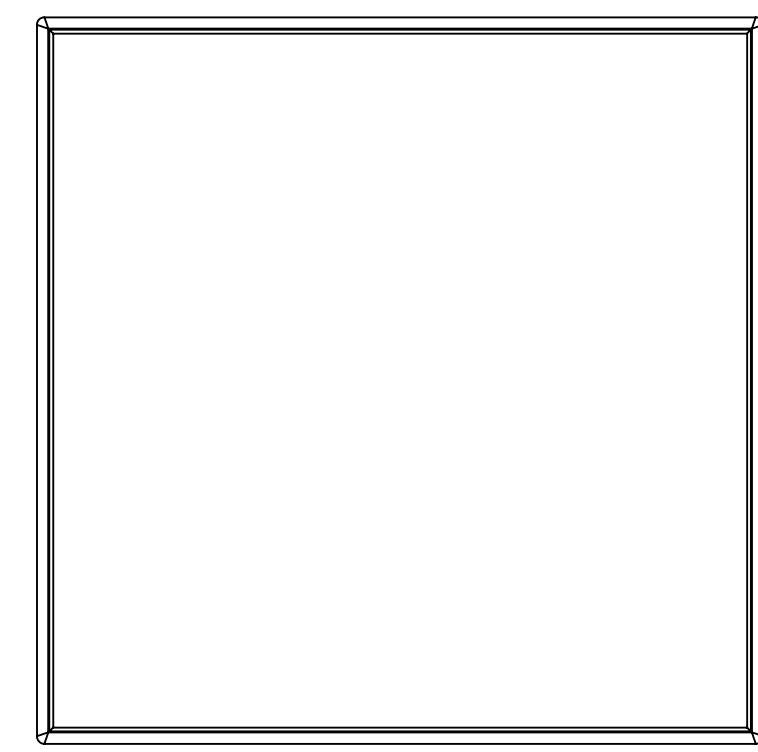

SURFACE-17

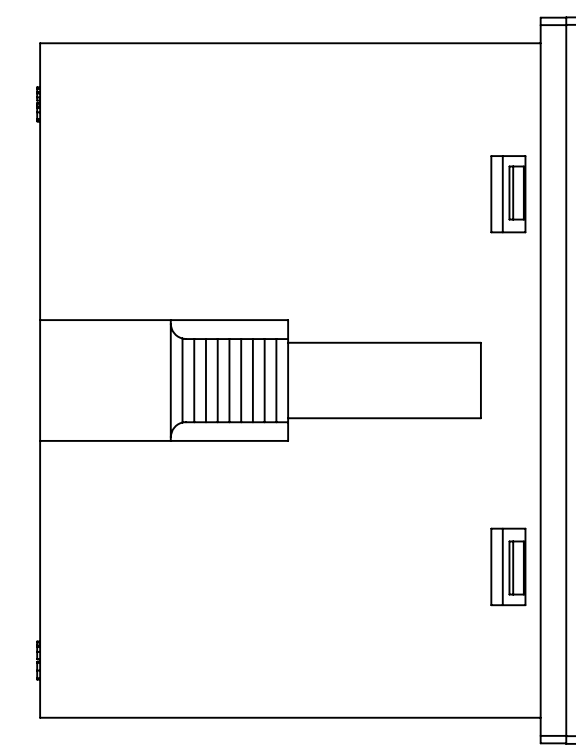

SURFACE-16

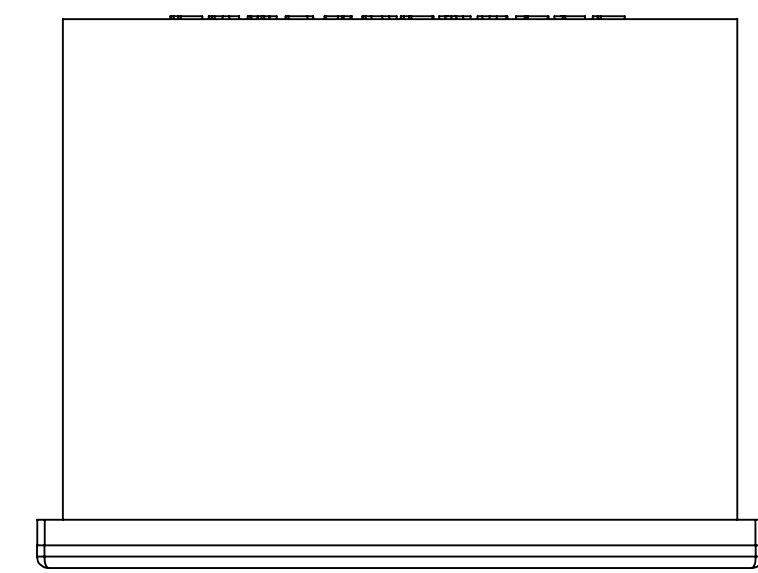

SURFACE-14

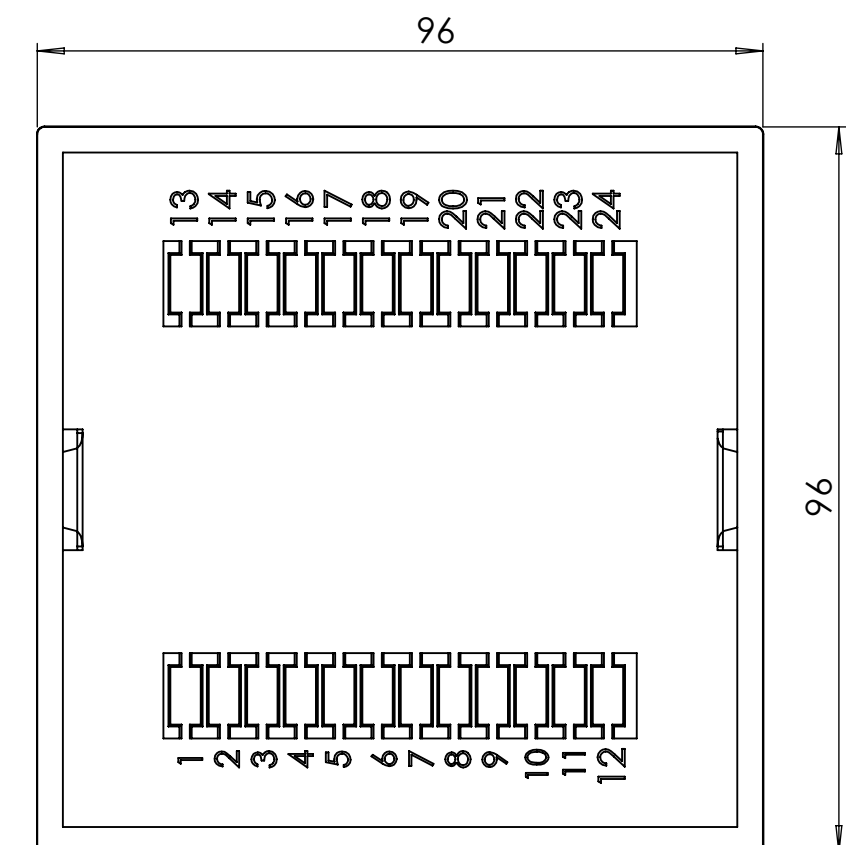

SURFACE-18

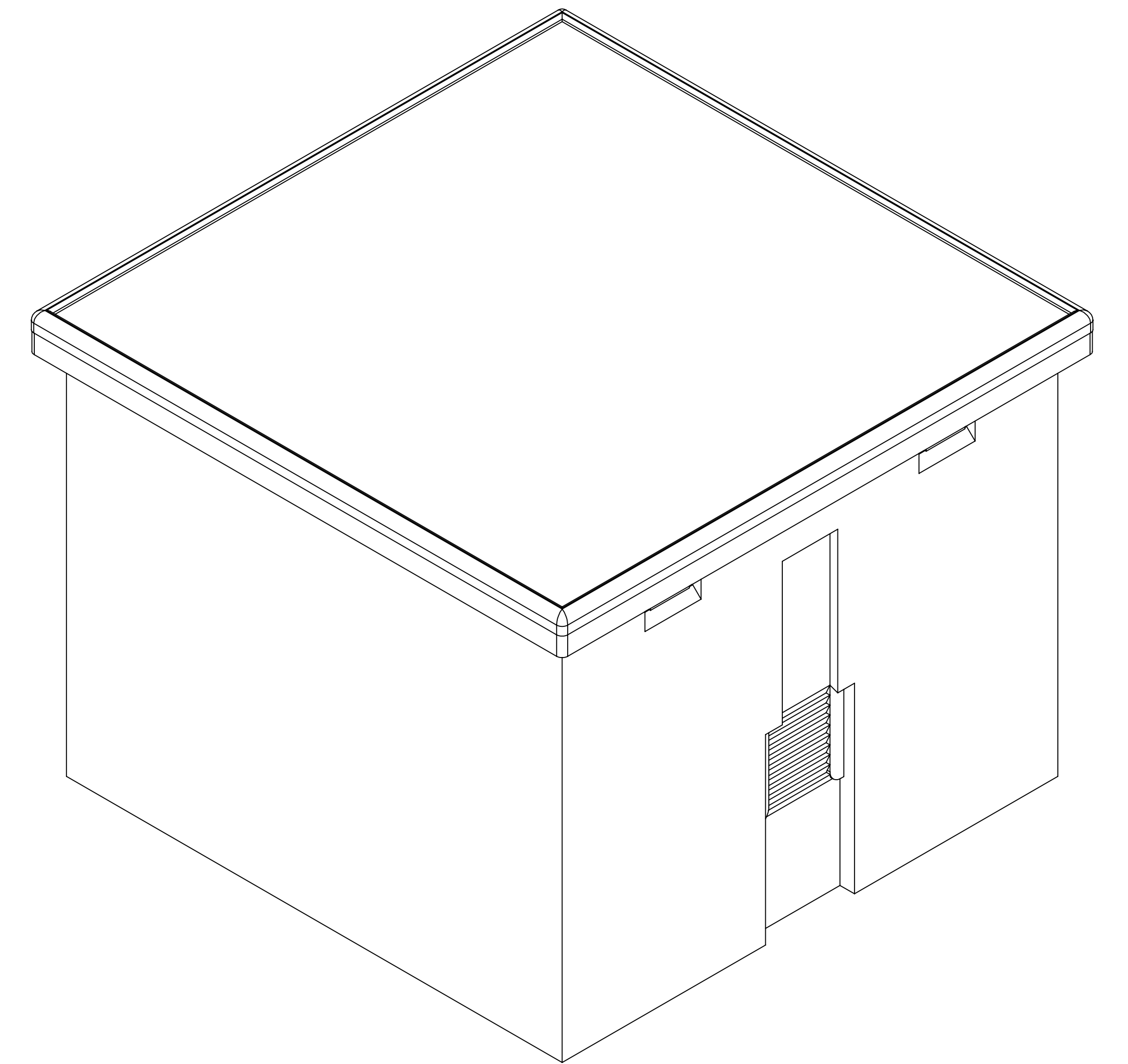
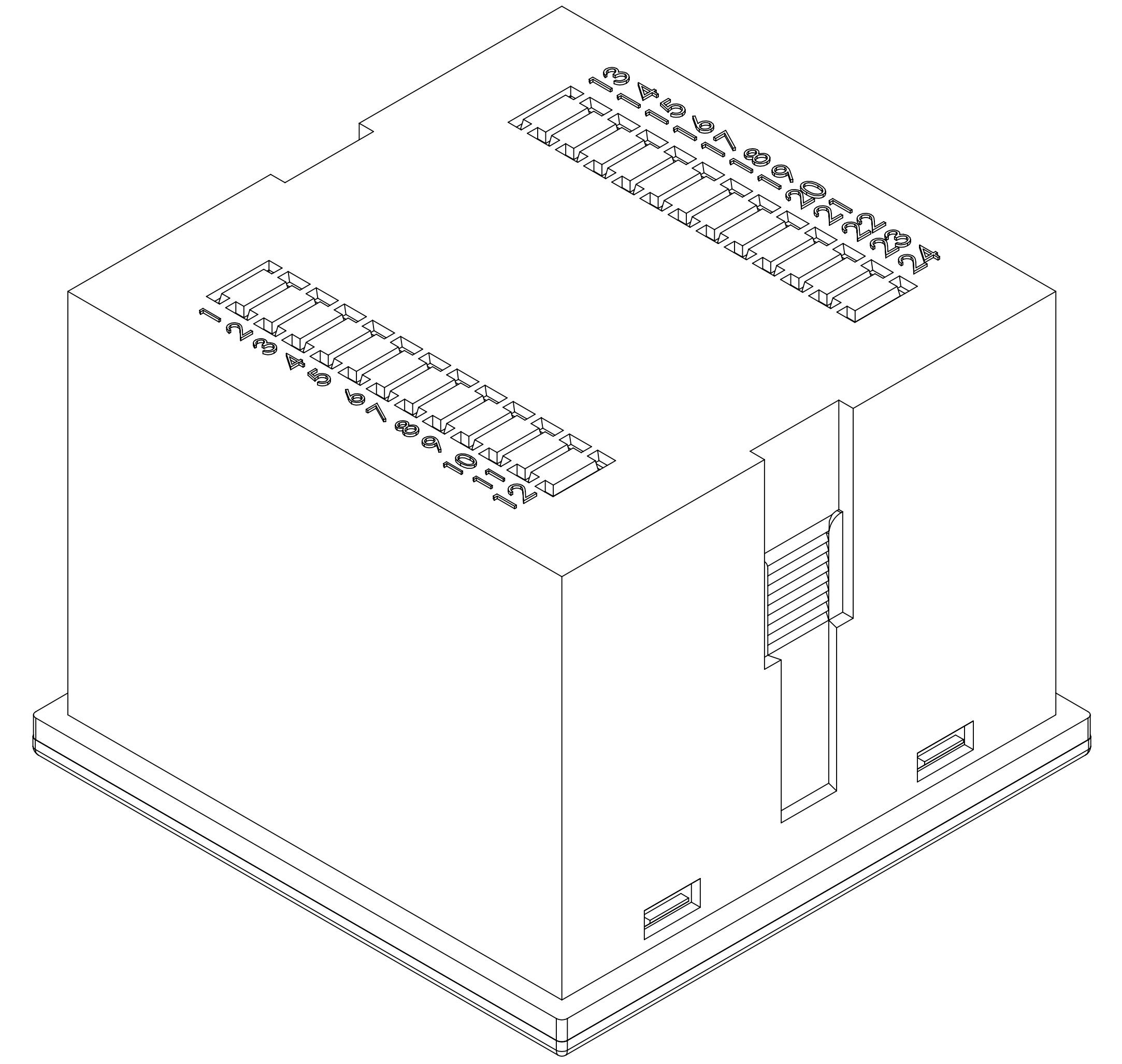

REV. NO	DATE	REVISED BY	DESCRIPTION OF CHANGE	
ALTINKAYA Electronic Enclosures & Components			www.altinkaya.com	
Customer Name:		Customer Ref.:		
Altinkaya Ref.:		Part Name: PT-220-01		
DRAWN	NAME	DATE	Drawn From:	SCALE 1:1
CHECKED	Y.YEL	7.10.2024	Weight:	SHEET 2 OF 2
DIMENSIONAL TOLERANCES UNLESS OTHERWISE SPECIFIED (DIN7168)		0.5-3mm	3-6mm	6-30mm
		±0.1	±0.1	±0.2
			±0.3	±0.5
				Dimension (mm)
				UNIT: mm
				A0