

# BASE: 6 SURFACE

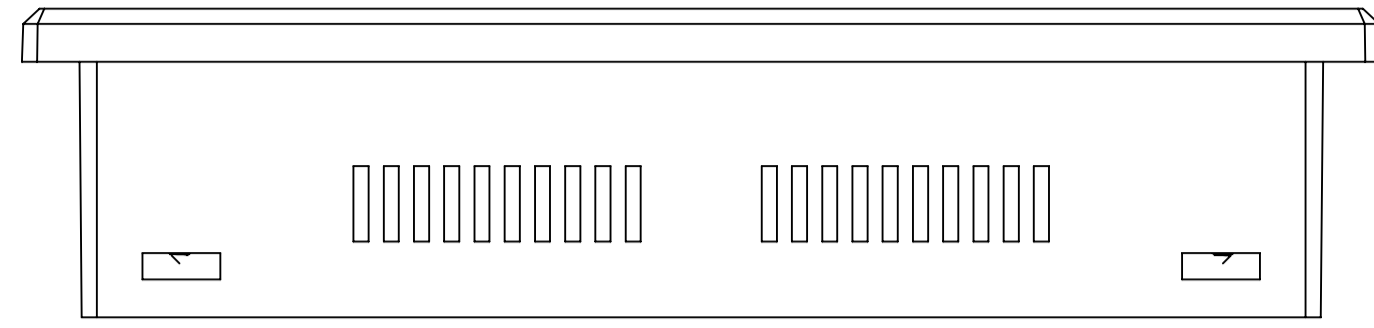

SURFACE-1

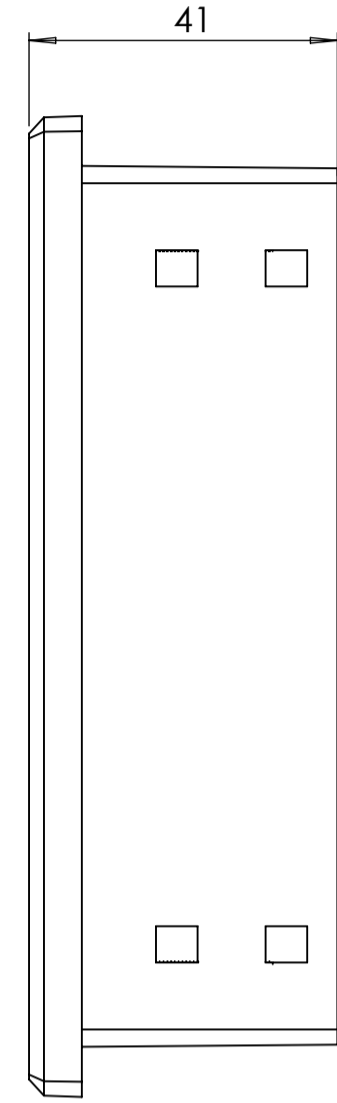

SURFACE-3

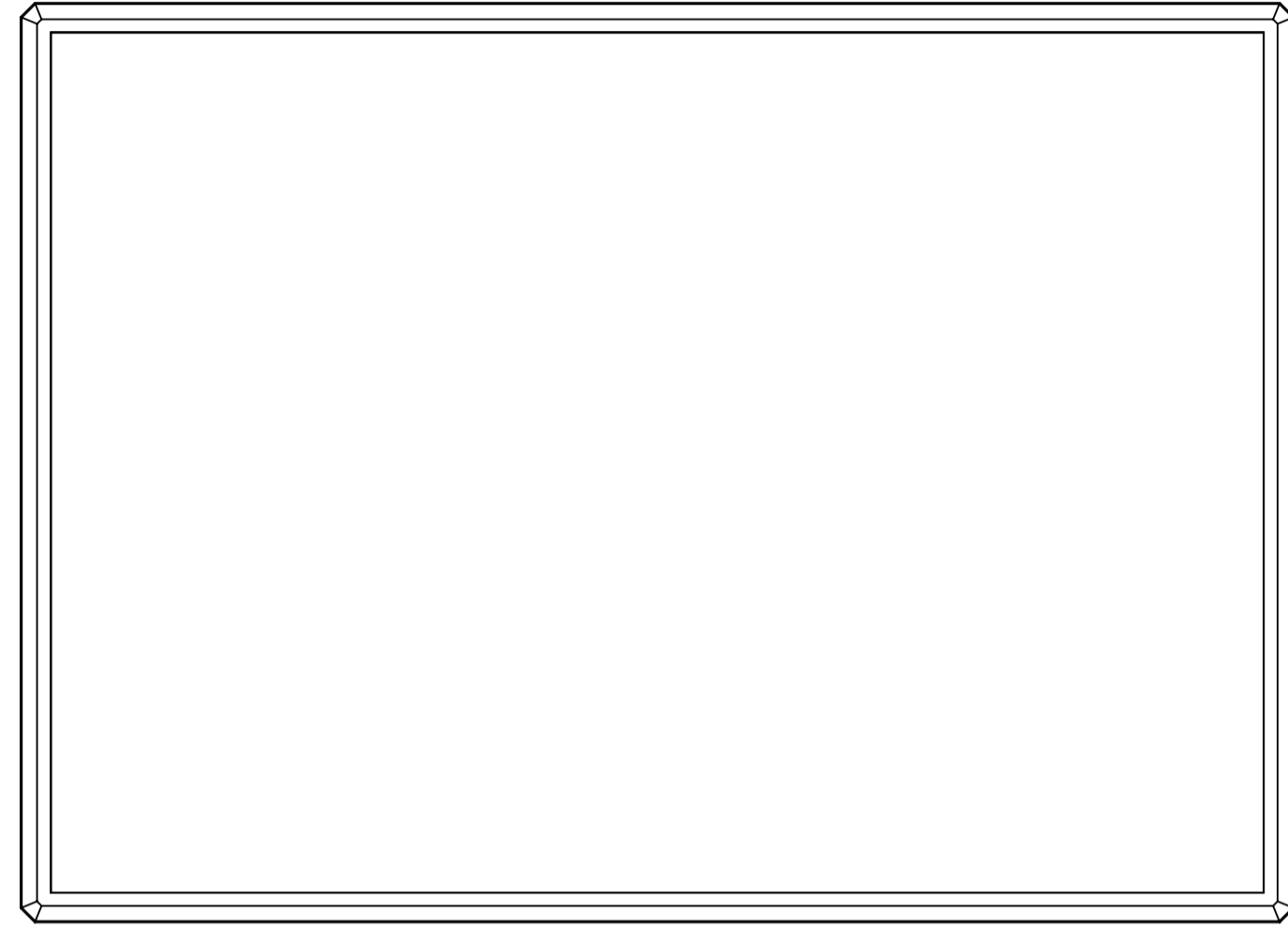

SURFACE-5

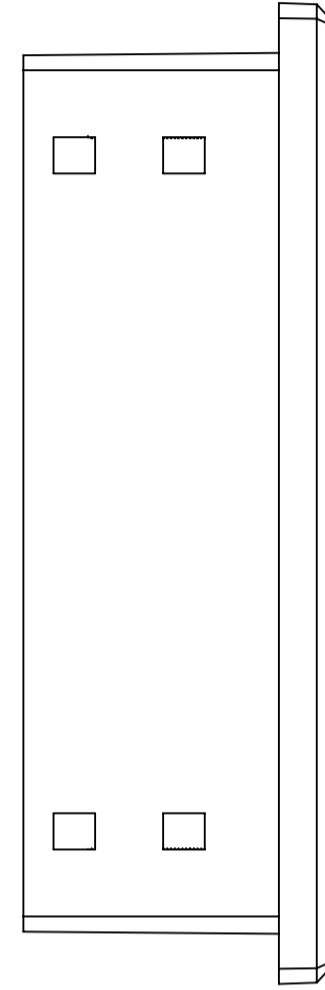

SURFACE-4

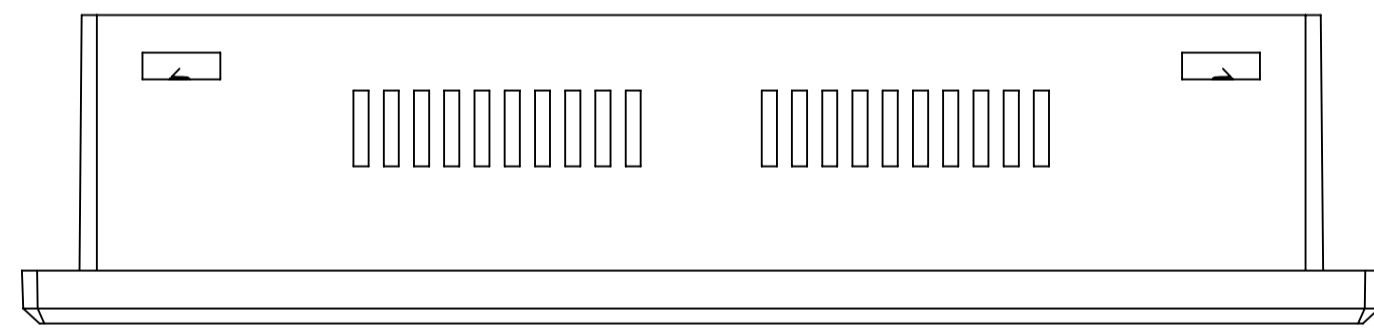

SURFACE-2

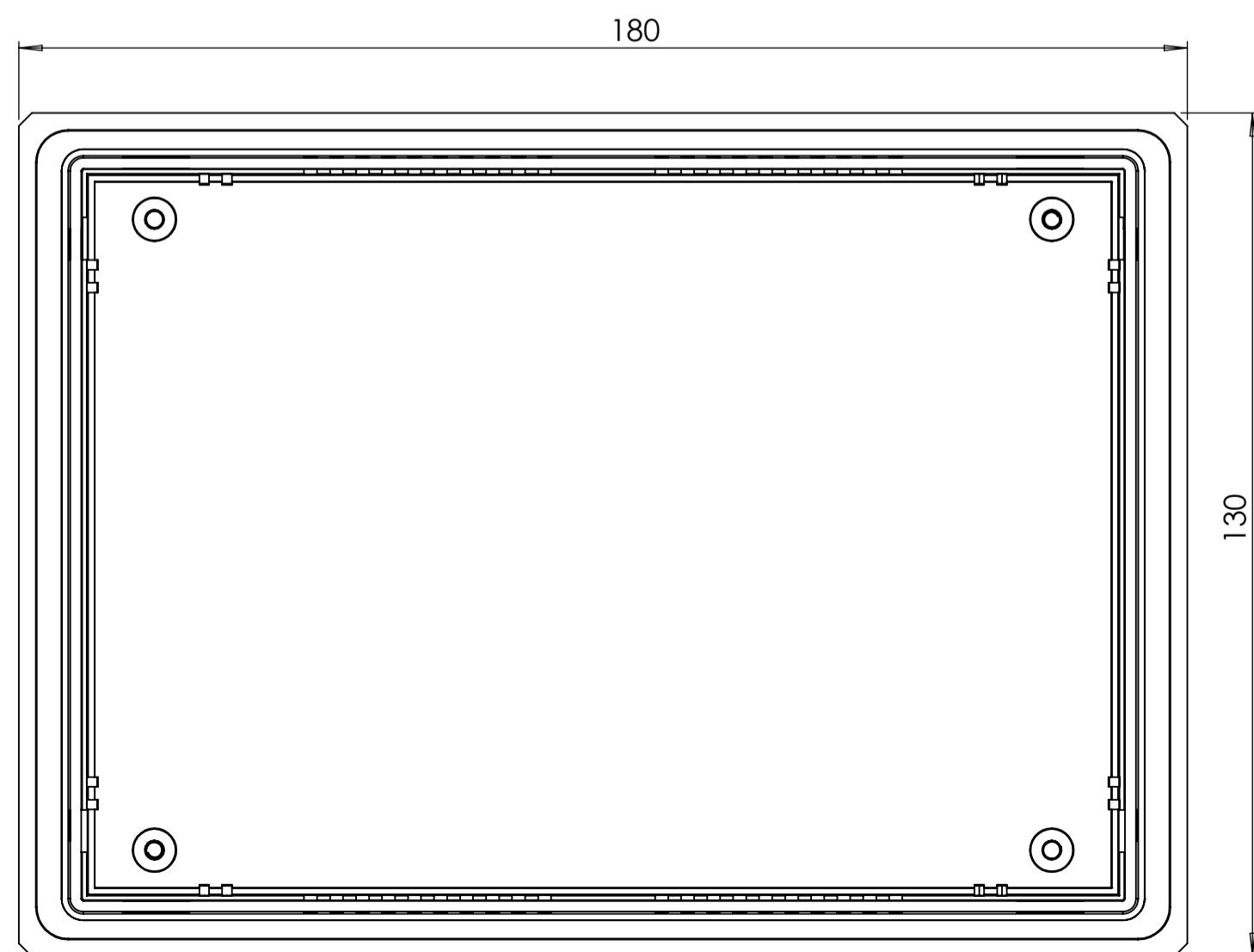

SURFACE-6 (INSIDE)

# COVER: 6 SURFACE

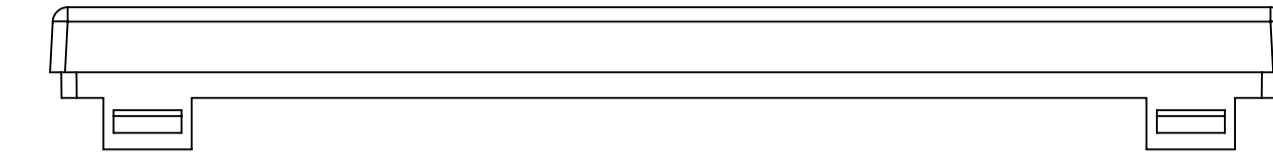

SURFACE-7

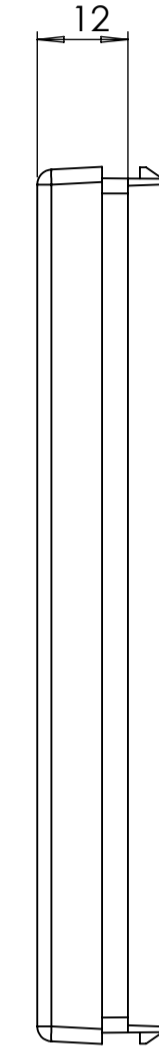

SURFACE-9

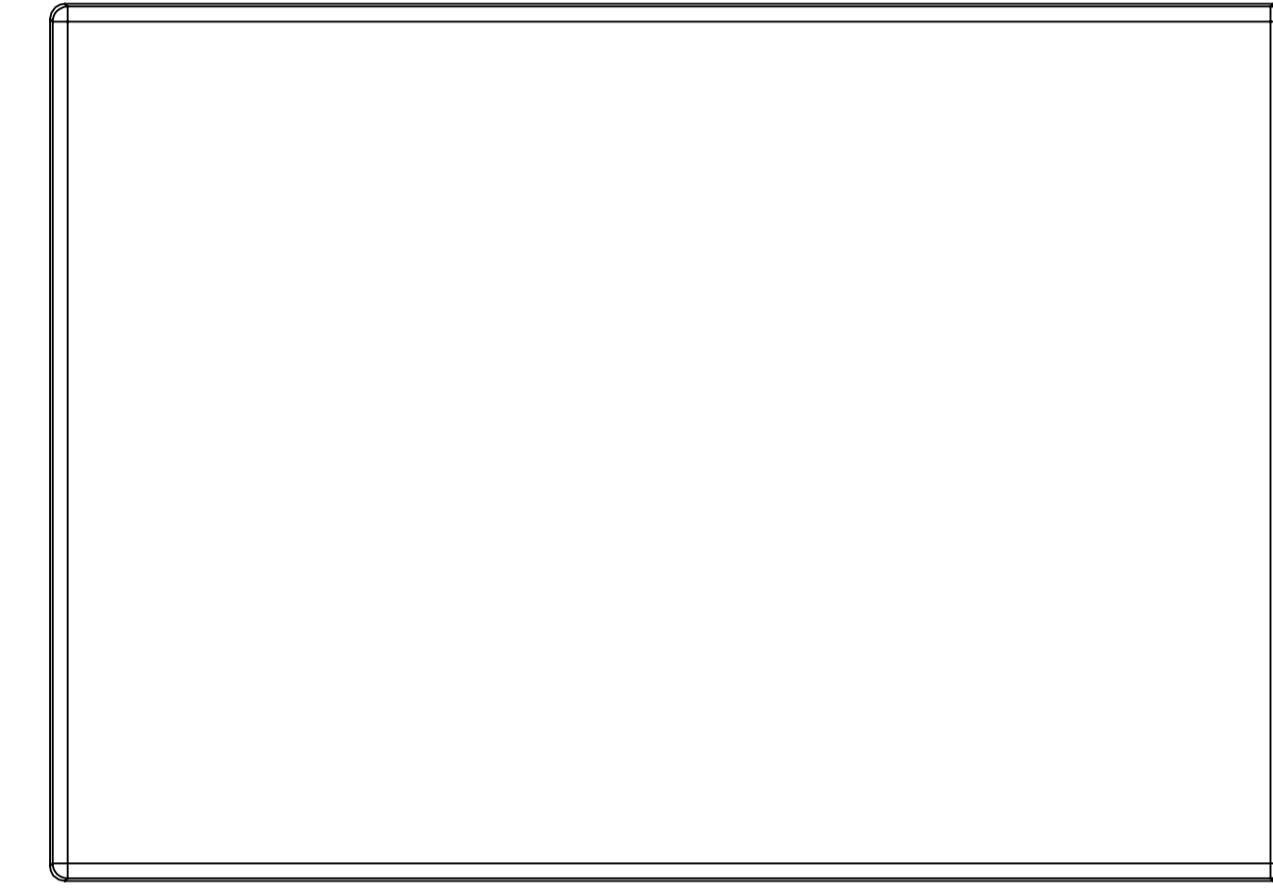

SURFACE-11

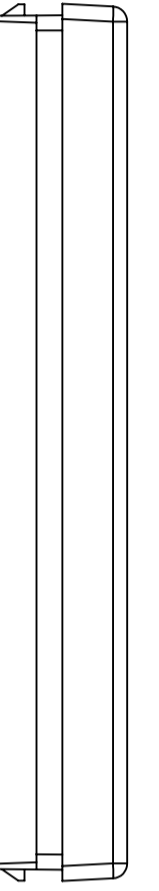

SURFACE-10

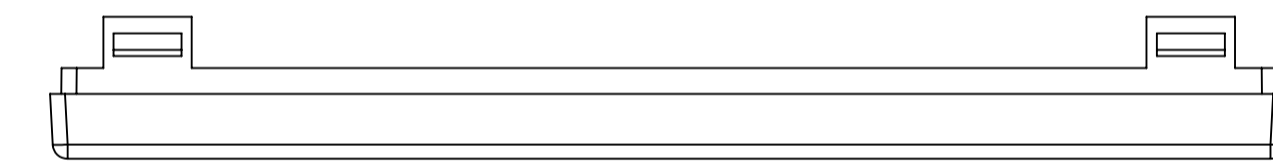

SURFACE-8

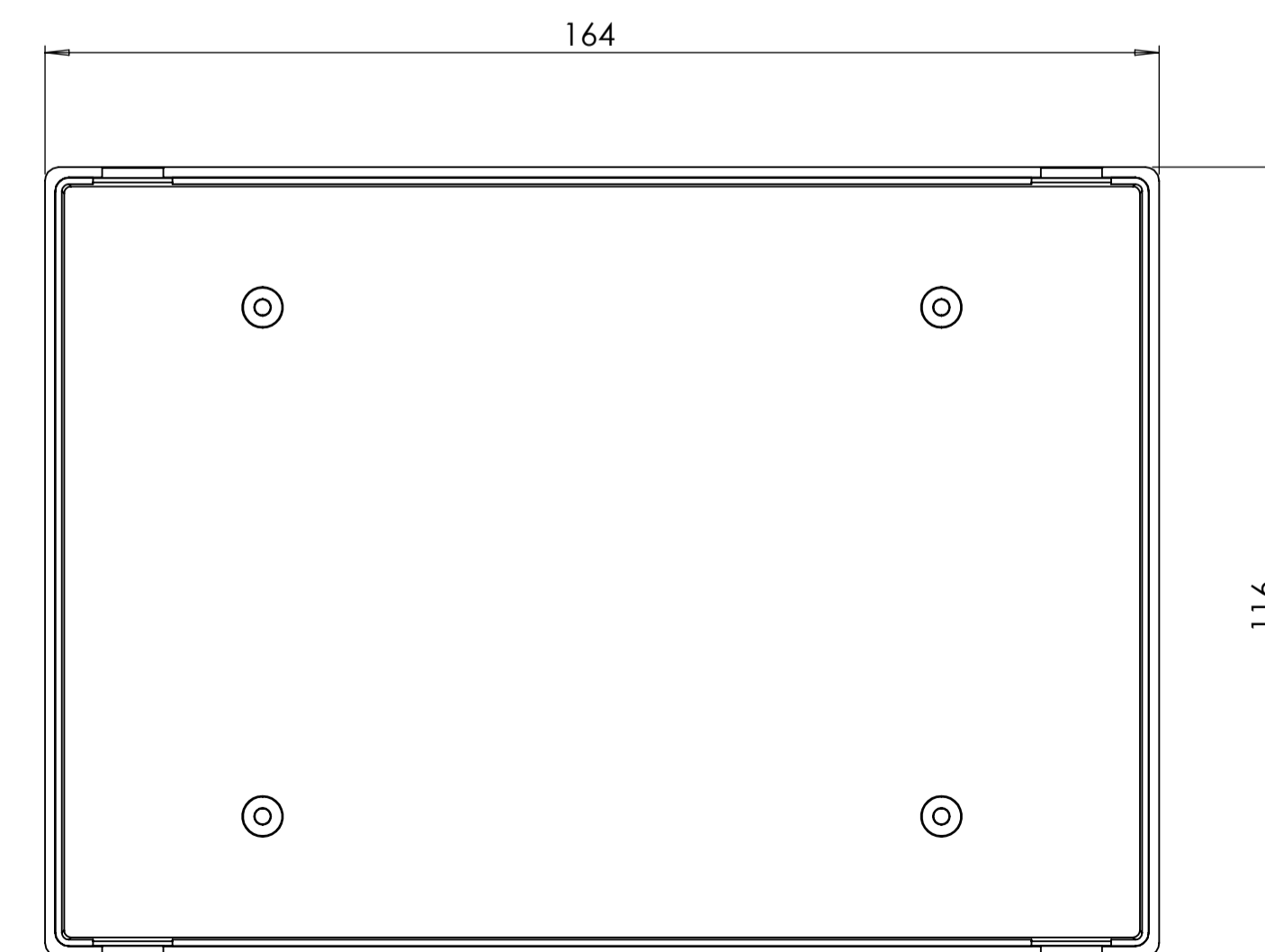

SURFACE-12 (INSIDE)

REV. NO.	DATE	REVISED BY	DESCRIPTION OF CHANGE
 <b>ALTINKAYA</b> Electronic Enclosures & Components			<a href="http://www.altinkaya.com">www.altinkaya.com</a>
Customer Name:		Customer Ref.:	
Altinkaya Ref.:		Part Name: OP-300-K	
DRAWN	NAME	DATE	Material:
CHECKED	Y. YESILOZ	23.09.2024	Weight:
DIMENSIONAL TOLERANCES UNLESS OTHERWISE SPECIFIED:		SCALE 1:1	UNIT : mm
±0.1	±0.1	±0.2	±0.3
±0.5			
Dimension(mm)			A1
m(medium)			SHEET 1 OF 2

# OP-300-K IF MACHINED TOGETHER

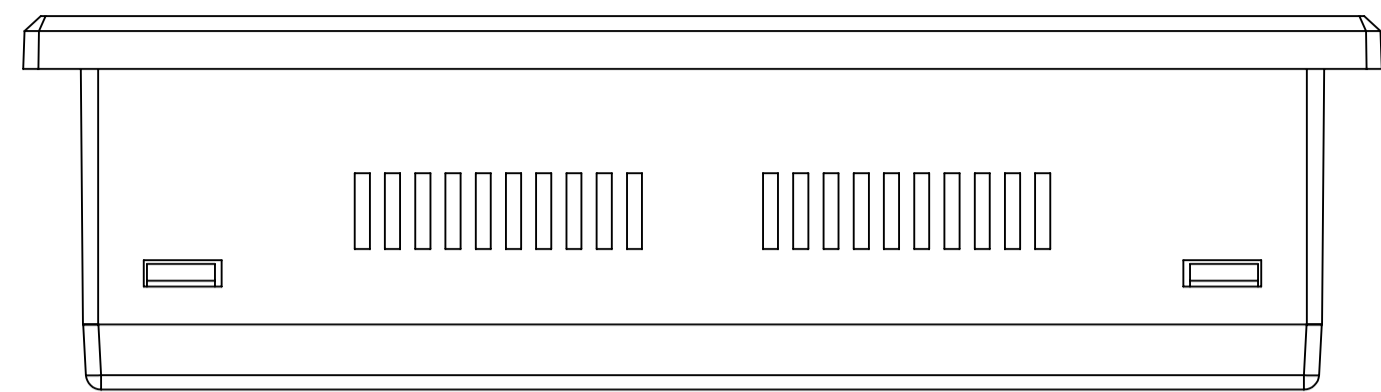

SURFACE-13

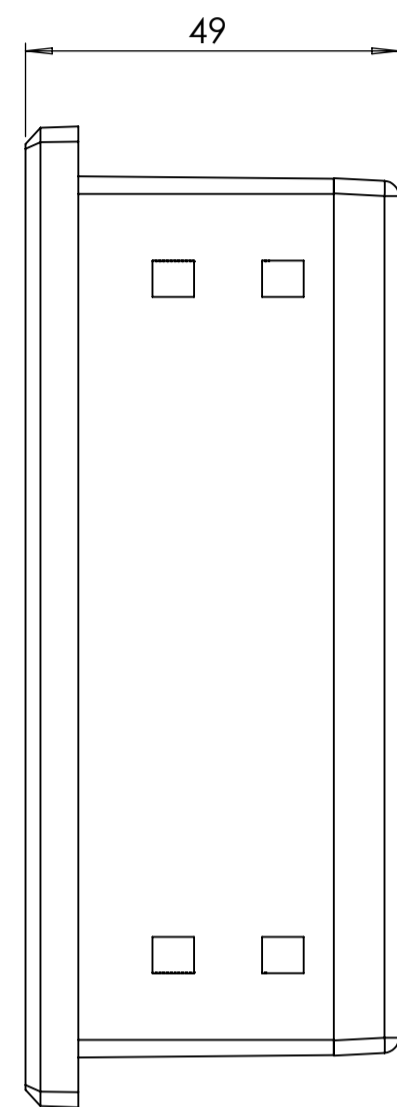
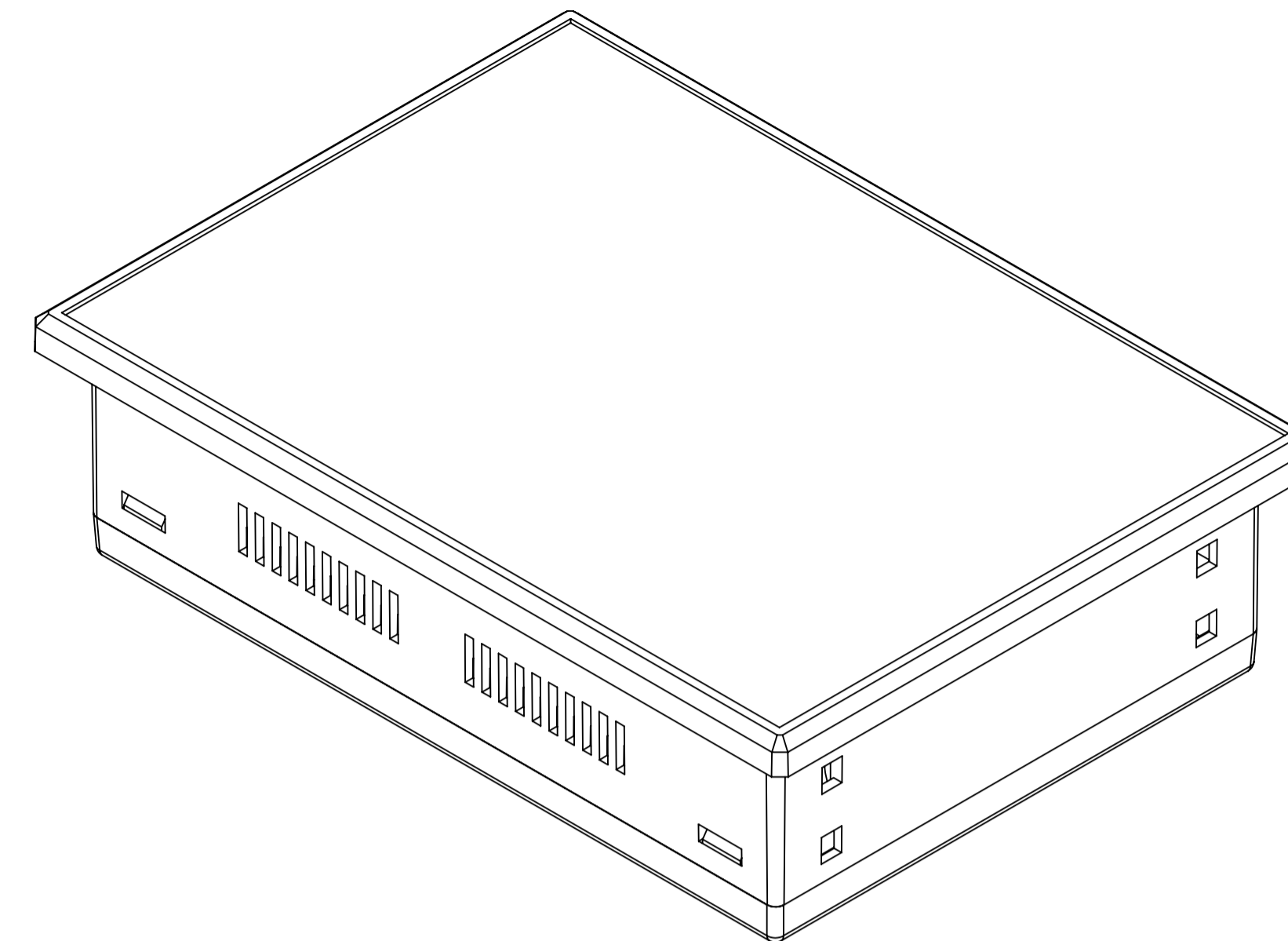

SURFACE-15

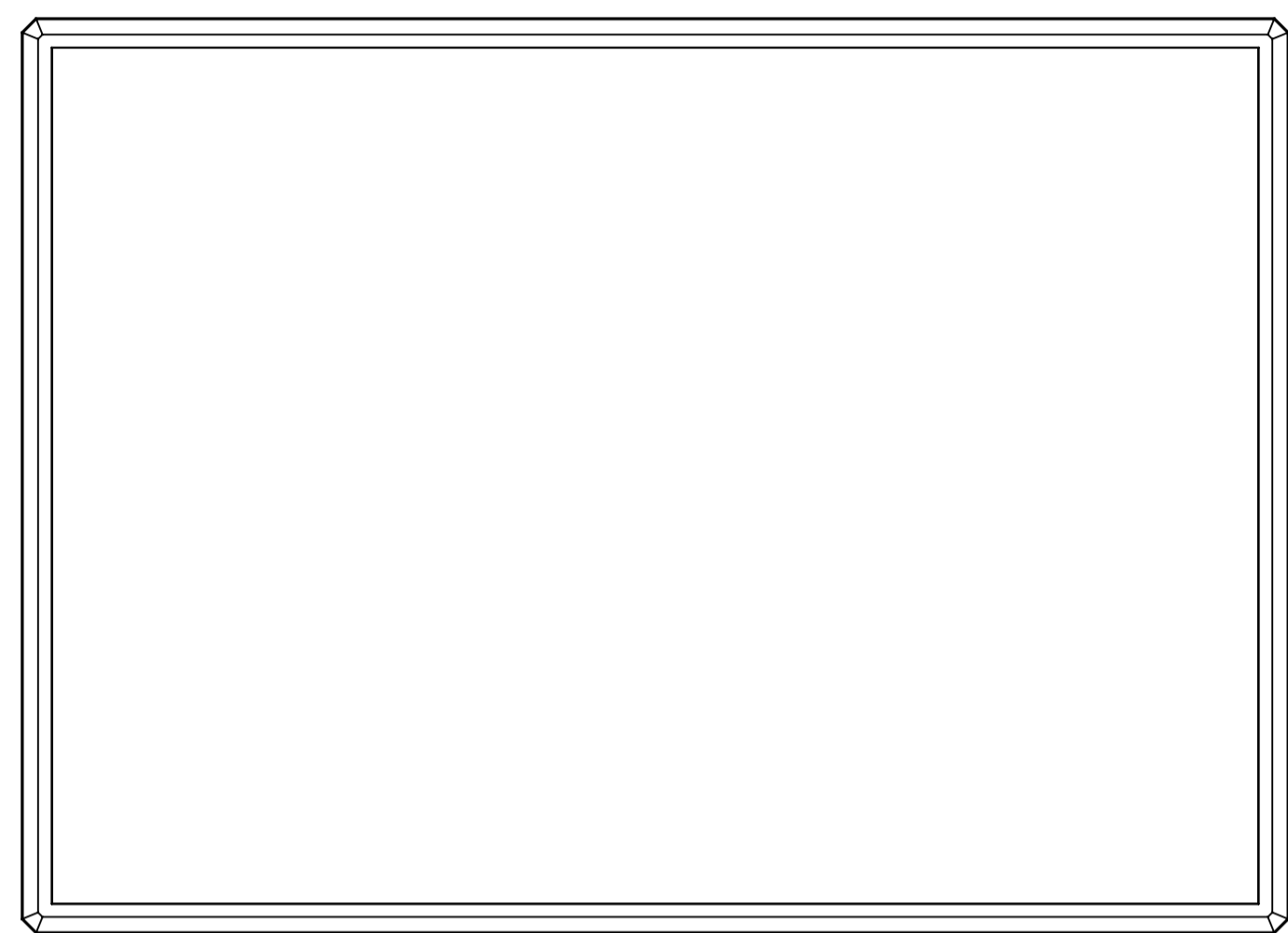

SURFACE-17

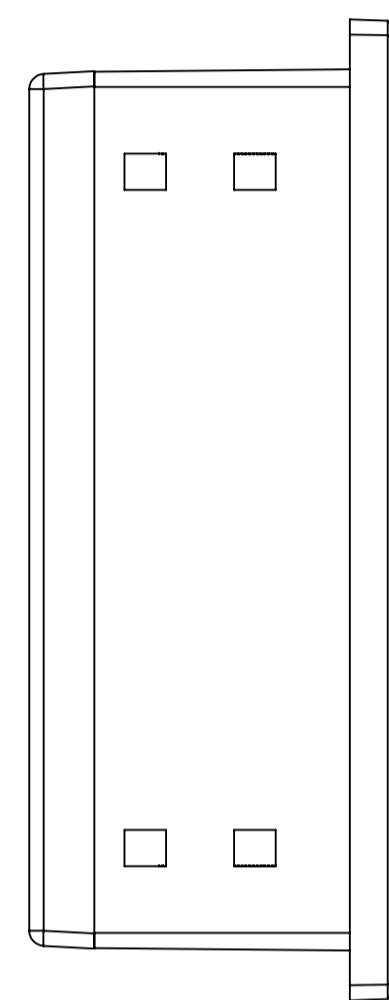

SURFACE-16

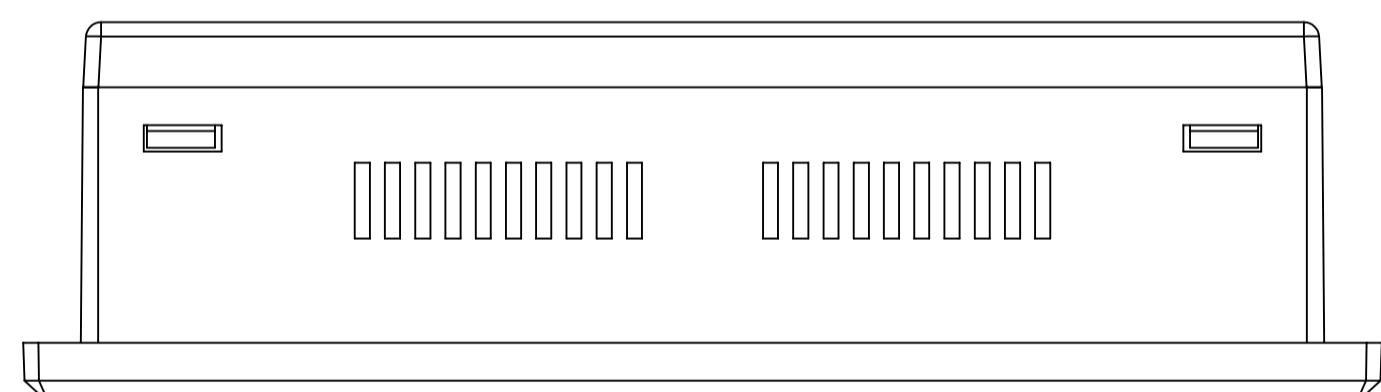

SURFACE-14

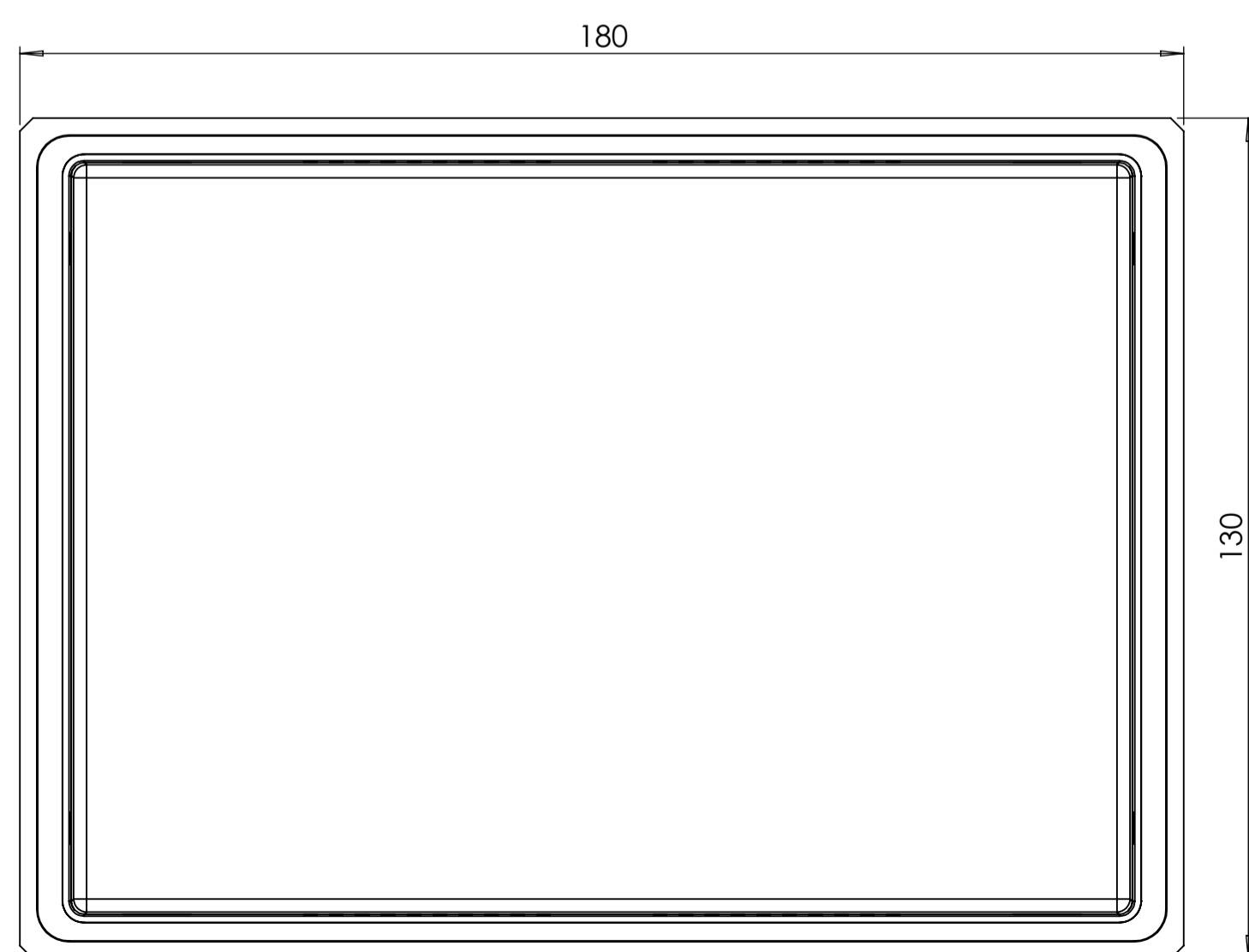
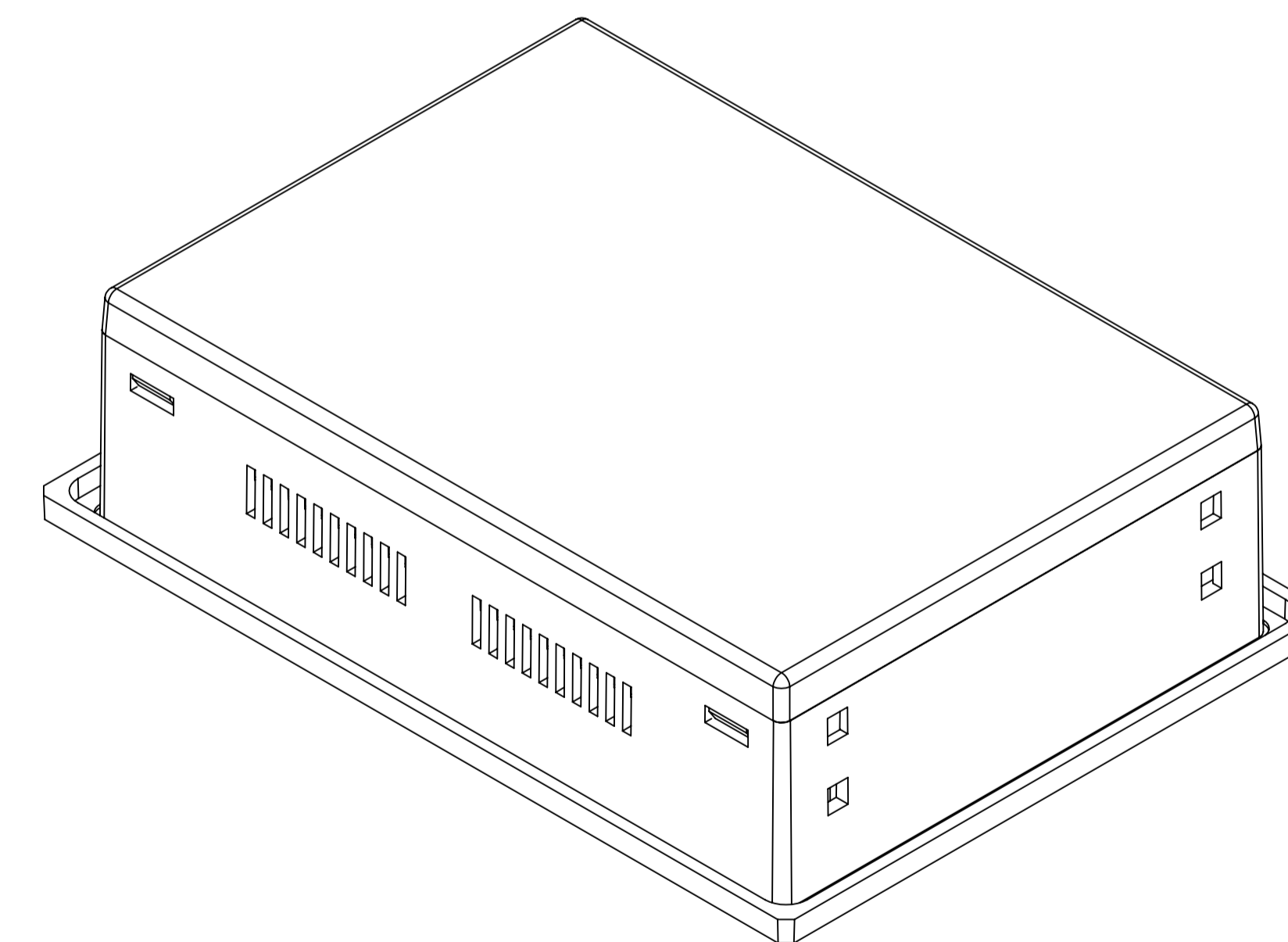

SURFACE-18

REV. NO.	DATE	REVISED BY	DESCRIPTION OF CHANGE
<span style="float: right;"><b>www.altinkaya.com</b></span>			
Customer Name:		Customer Ref.:	
Altinkaya Ref.:		Part Name: OP-300-K	
DRAWN	NAME	DATE	Material:
CHECKED	Y. YESILOZ	23.09.2024	Weight:
DIMENSIONAL TOLERANCES UNLESS OTHERWISE SPECIFIED:			SCALE 1:1 UNIT : mm
(R&T/148)	±0.1	±0.1	±0.3 ±0.5