

**BASE: 6 SURFACE**

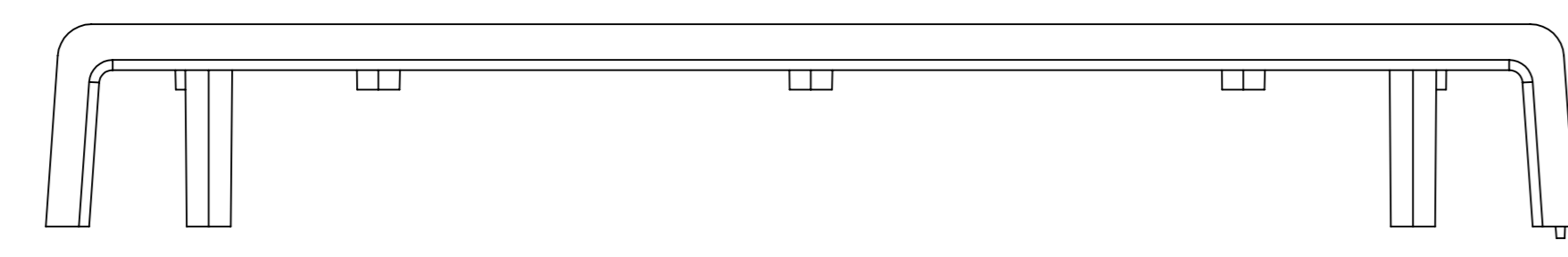

SURFACE-1

30

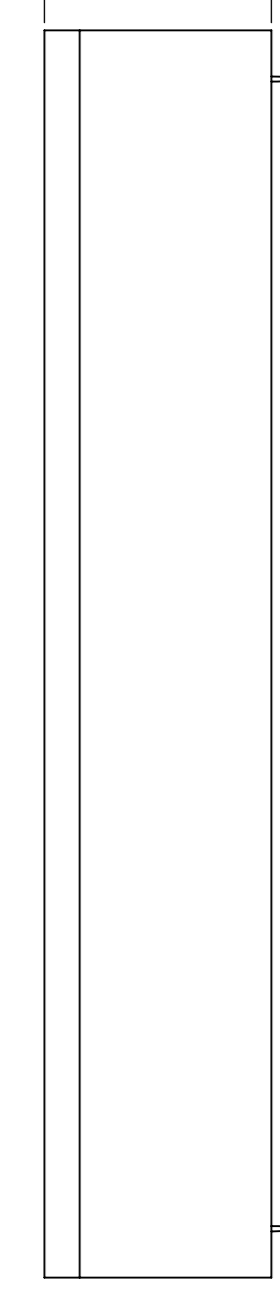

SURFACE-3



SURFACE-5

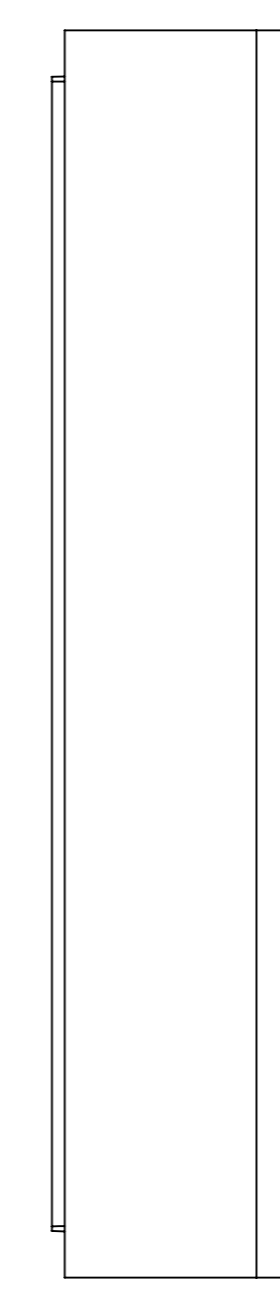

SURFACE-4

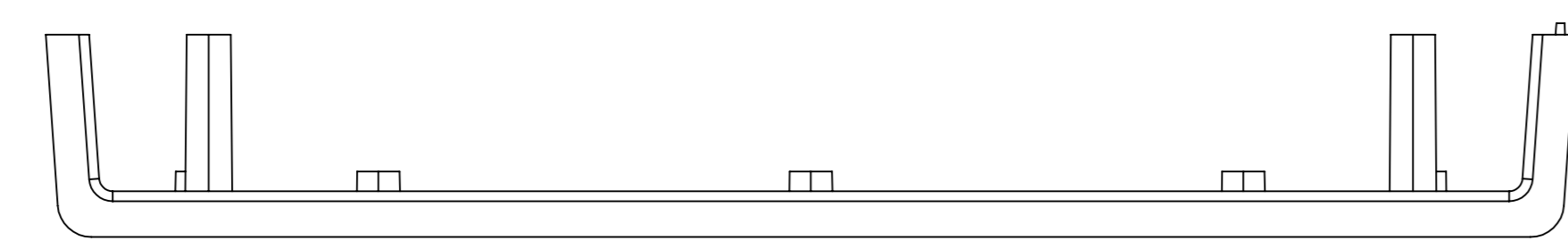

SURFACE-2

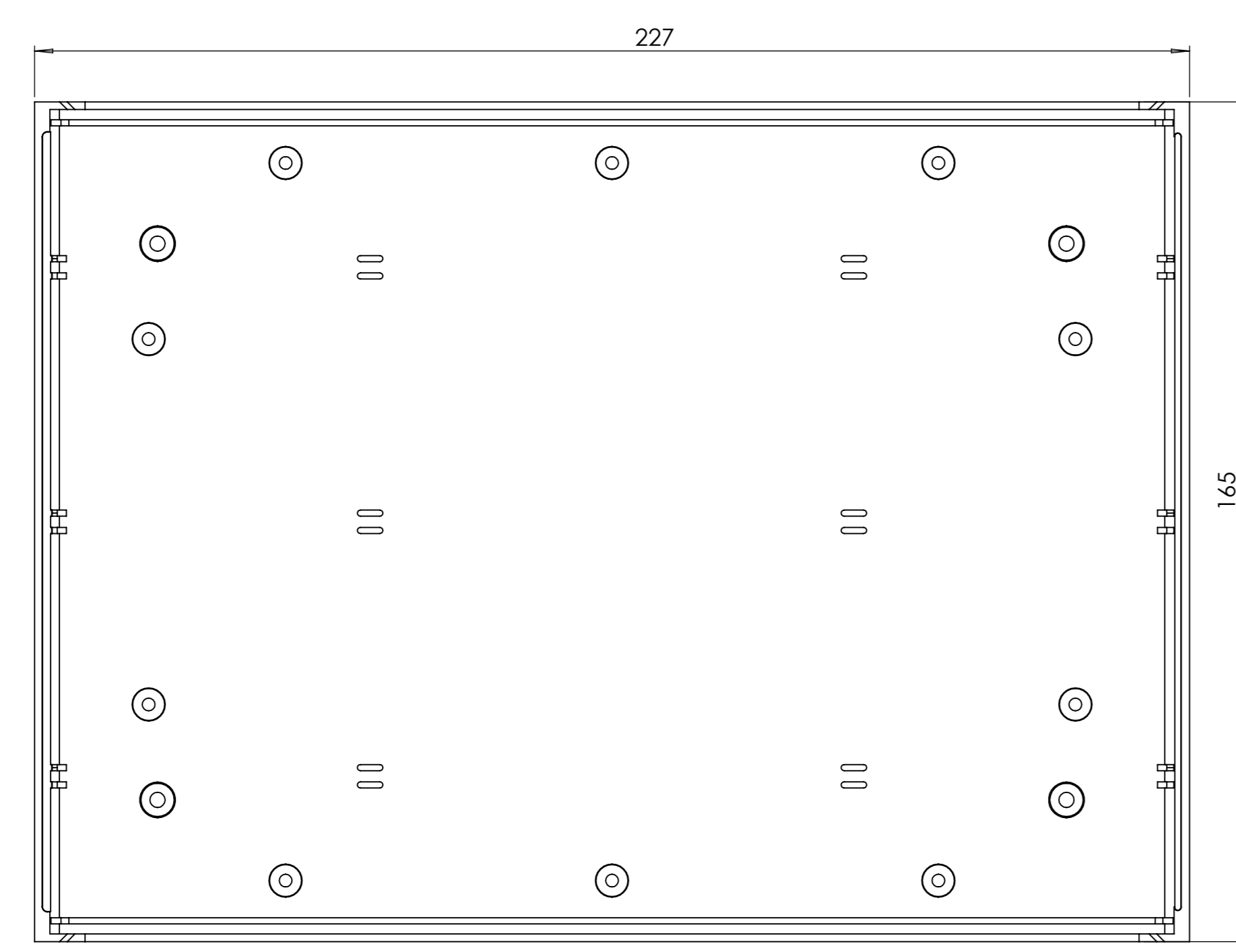
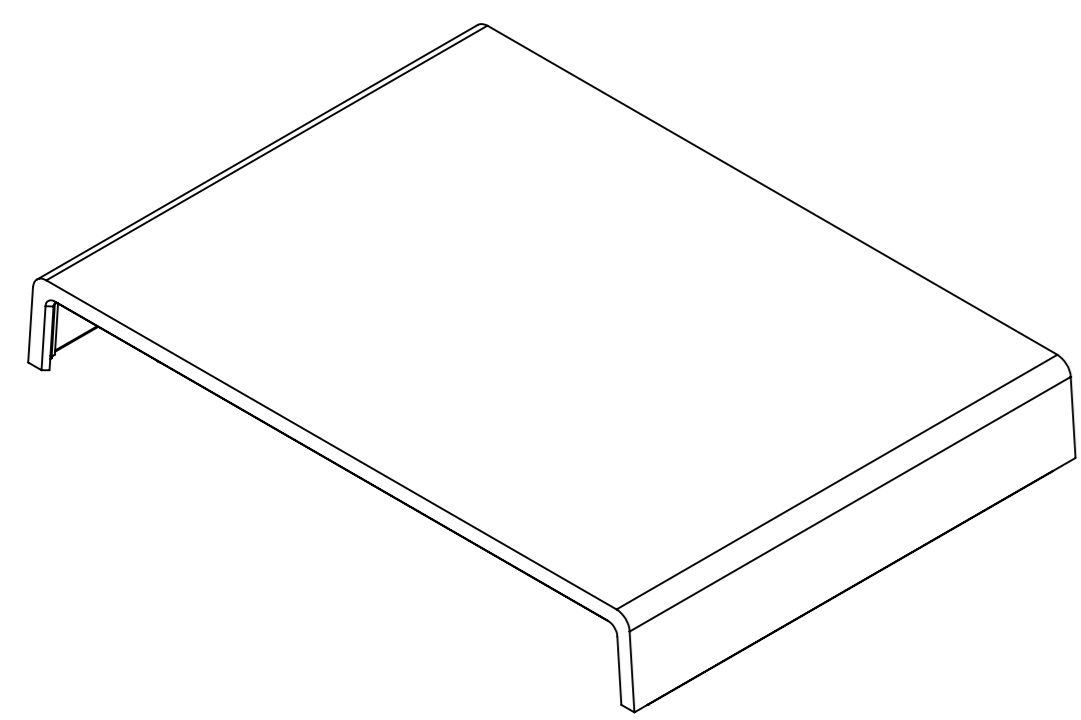

SURFACE-6 (INSIDE)

**COVER: 6 SURFACE**

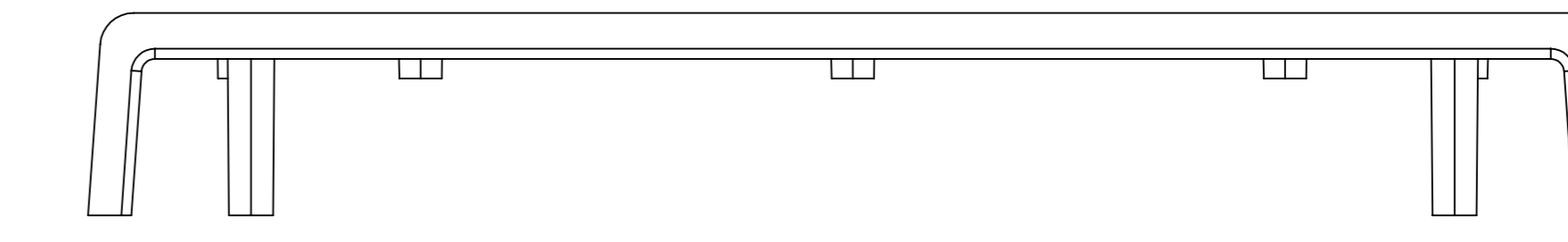

SURFACE-7

30

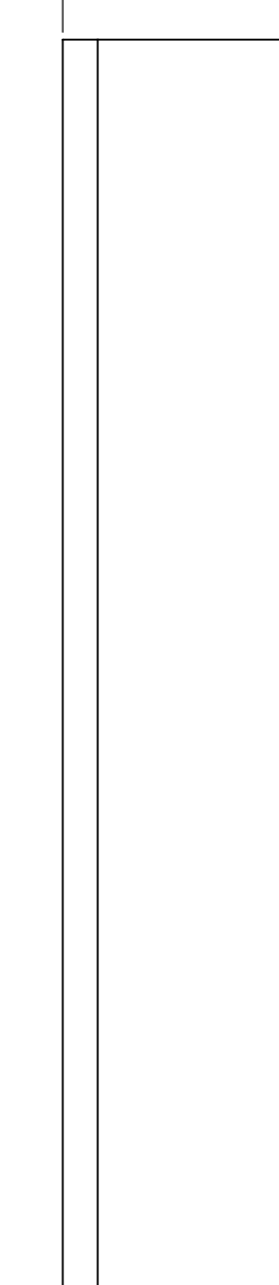

SURFACE-9

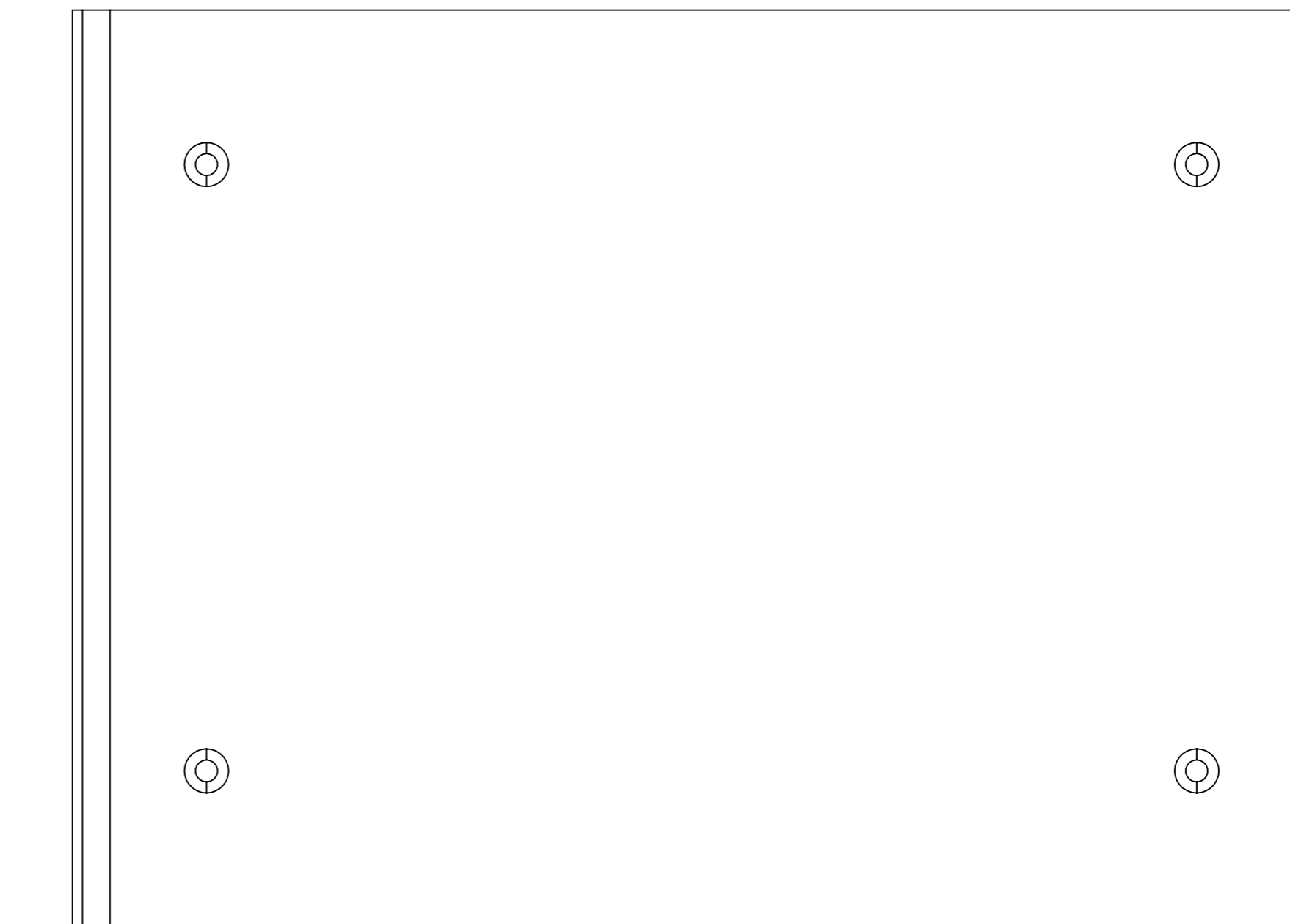

SURFACE-11

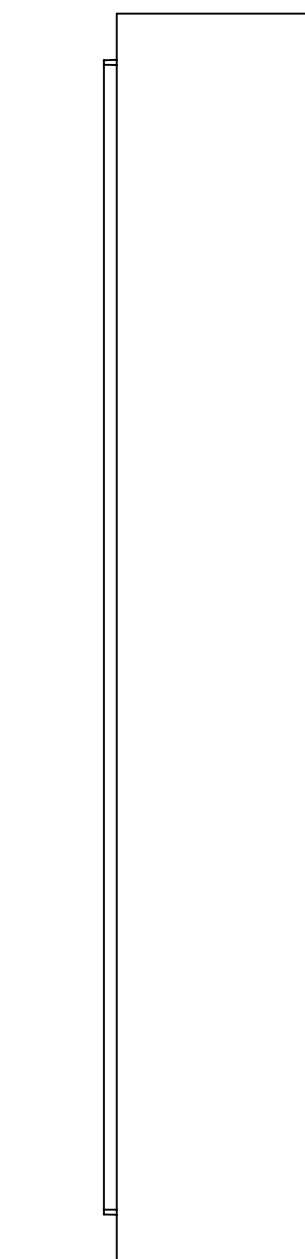

SURFACE-10

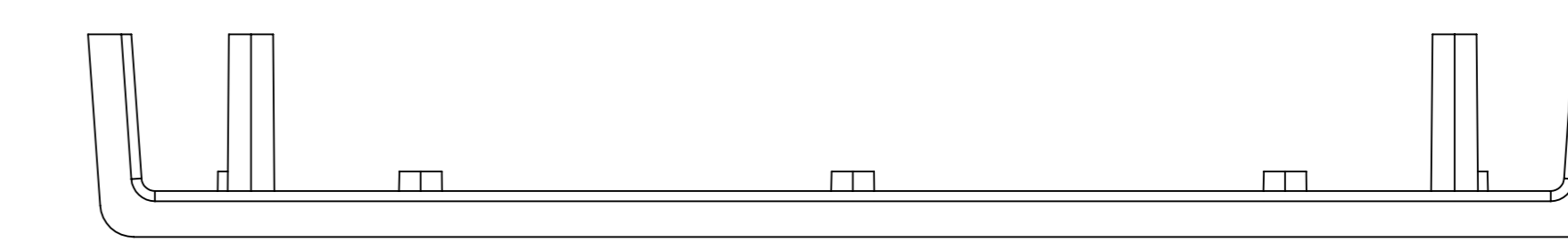

SURFACE-8

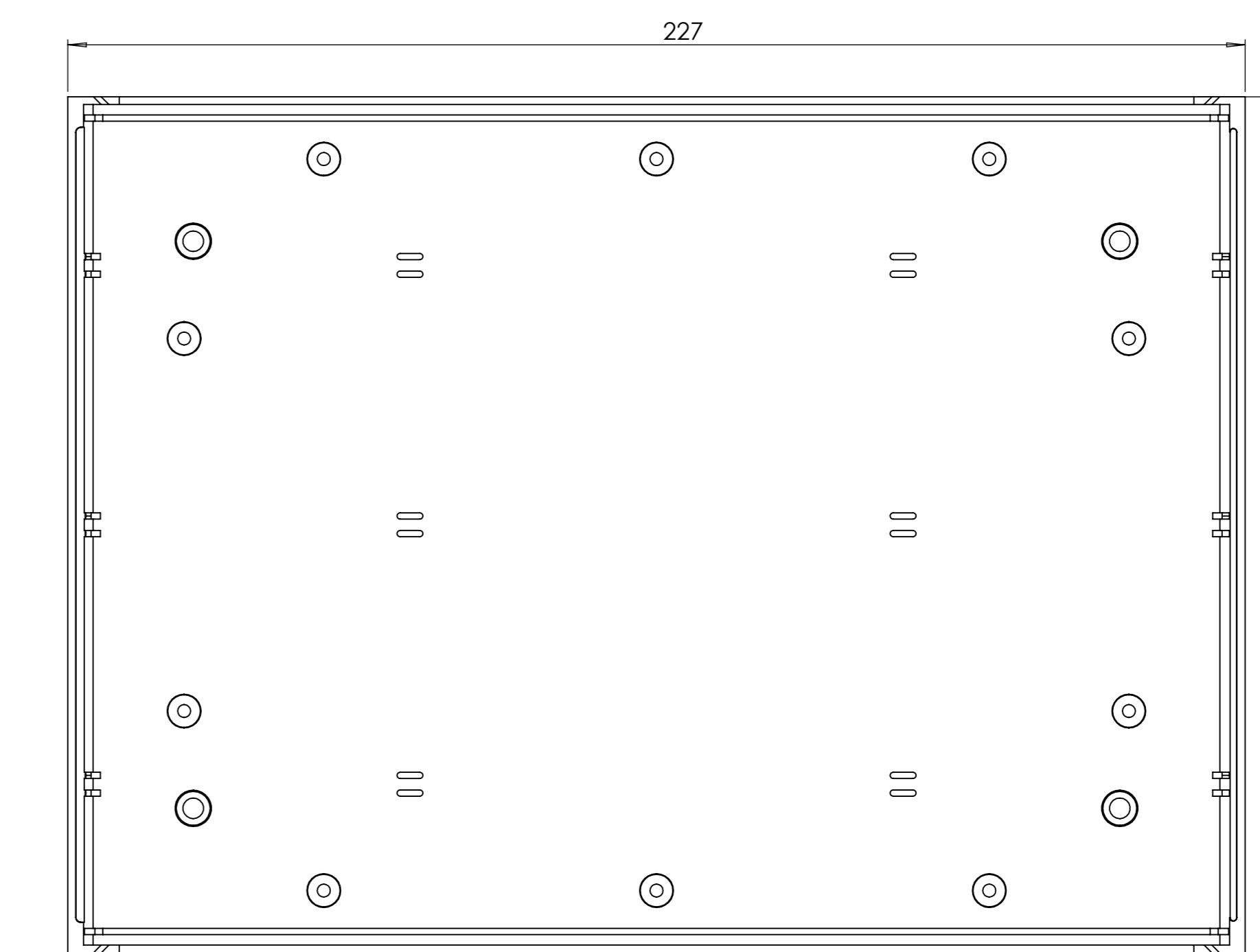
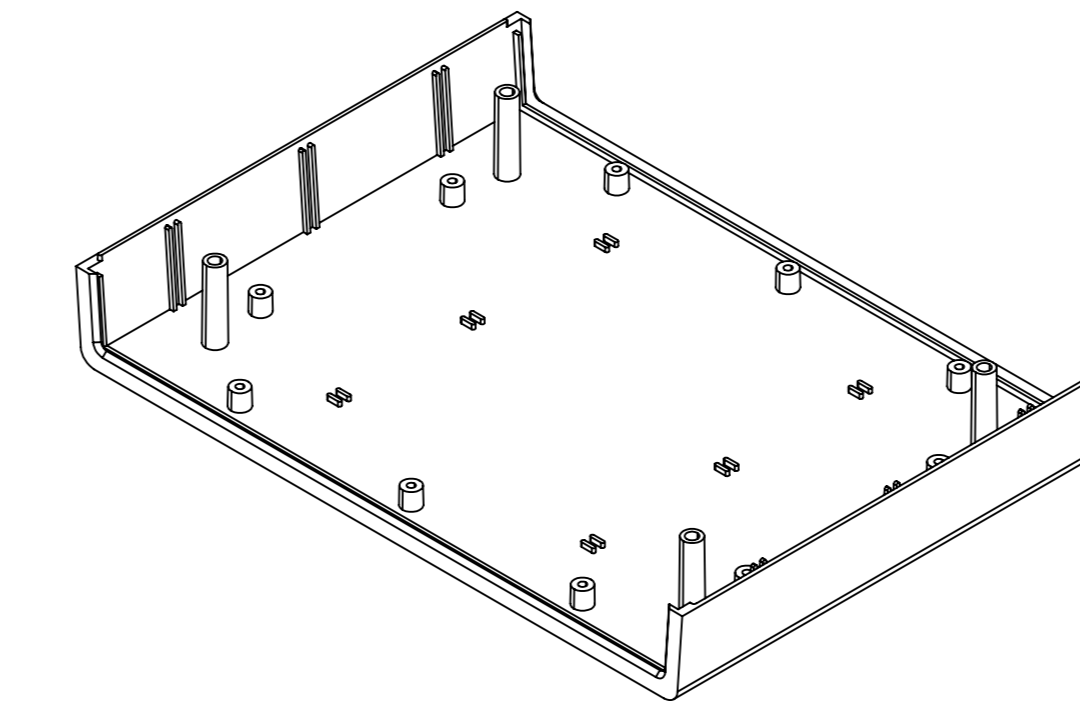

SURFACE-12 (INSIDE)

**PANEL-1: 2 SURFACE**

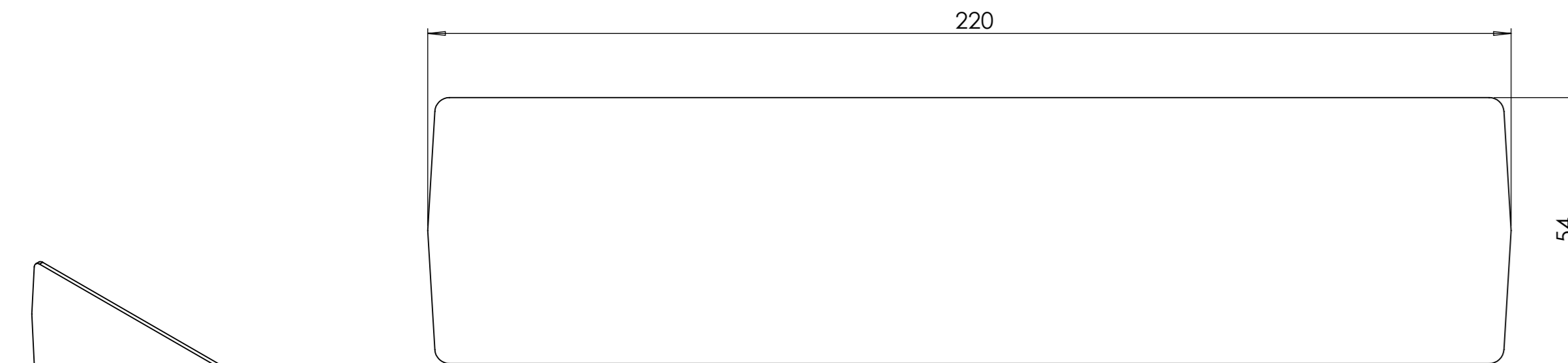

SURFACE-13



SURFACE-14

**PANEL-2: 2 SURFACE**

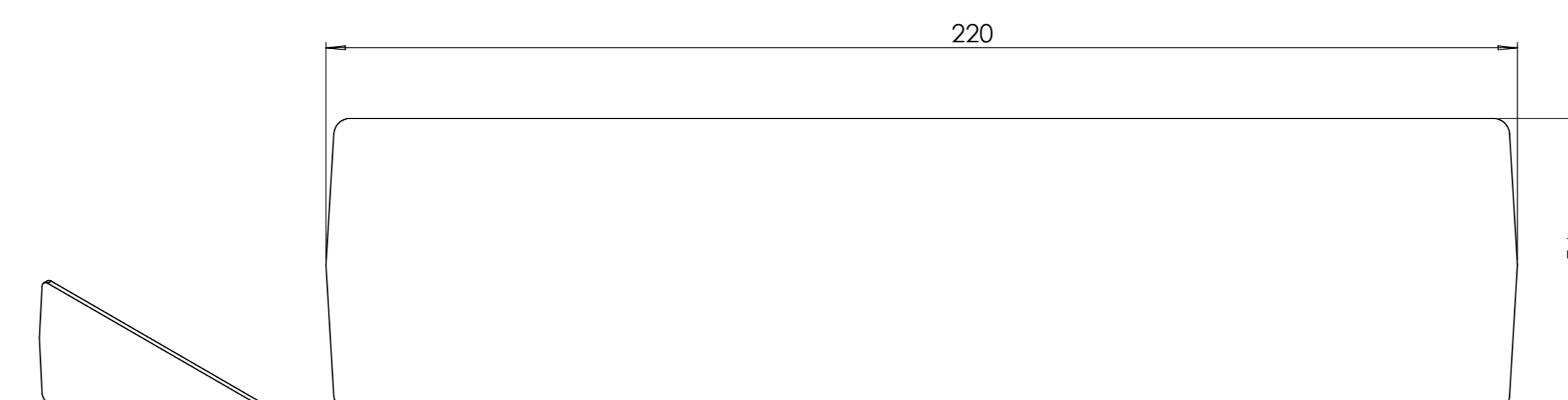

SURFACE-15



SURFACE-16

REV. NO	DATE	REVISED BY	DESCRIPTION OF CHANGE
			<b>ALTINKAYA</b> Electronic Enclosures & Components
Customer Name :		Customer Ref. :	
Altinkaya Ref :		Part Name: DT-220-0-0	
DRAWN	NAME	DATE	Drawn From:
CHECKED	Y.YEL	15.10.2024	Material:
DIMENSIONAL TOLERANCES UNLESS OTHERWISE SPECIFIED (DIN7168)			Weight:
±0,1	±0,1	±0,2	±0,3
±0,5	±0,5	±0,5	±0,5
			UNIT: mm
			Dimension(mm)
			m (medium)

**DT-220 IF MACHINED TOGETHER**

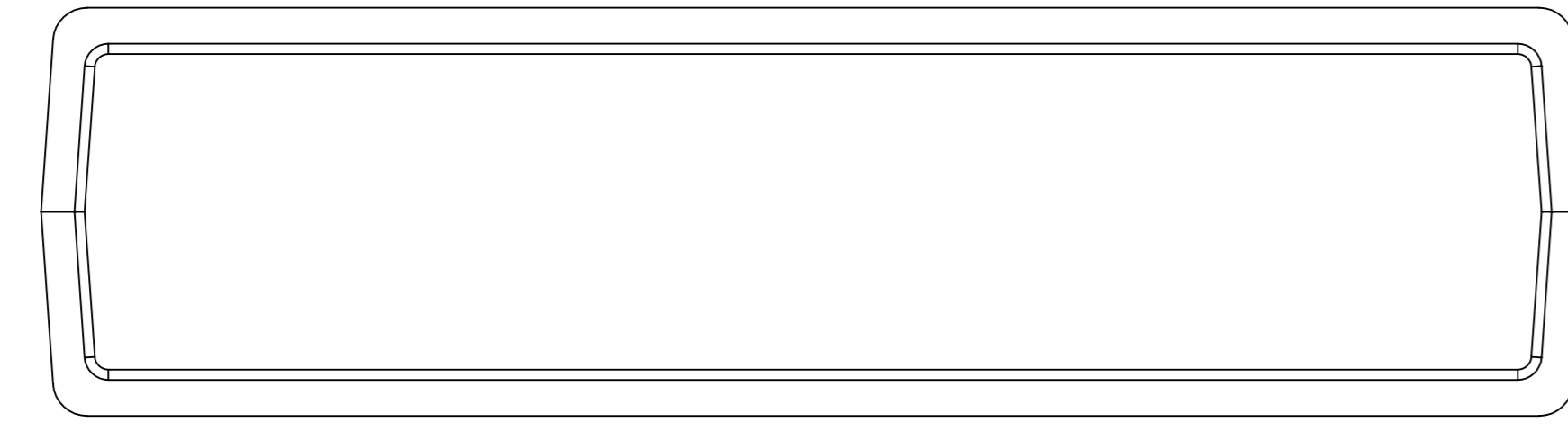

SURFACE-17

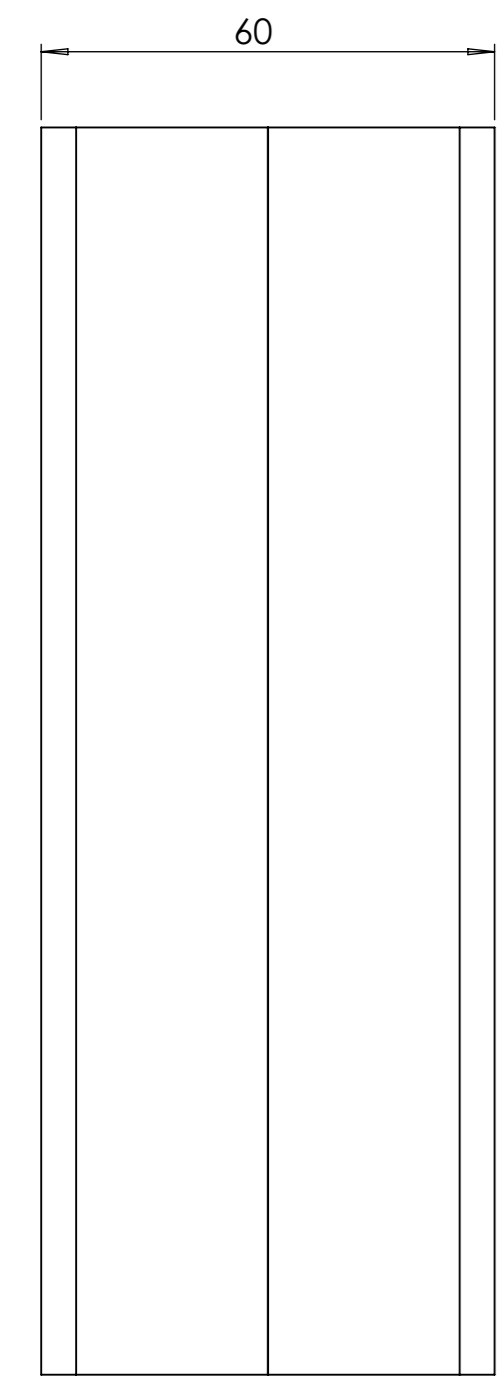

SURFACE-19



SURFACE-21

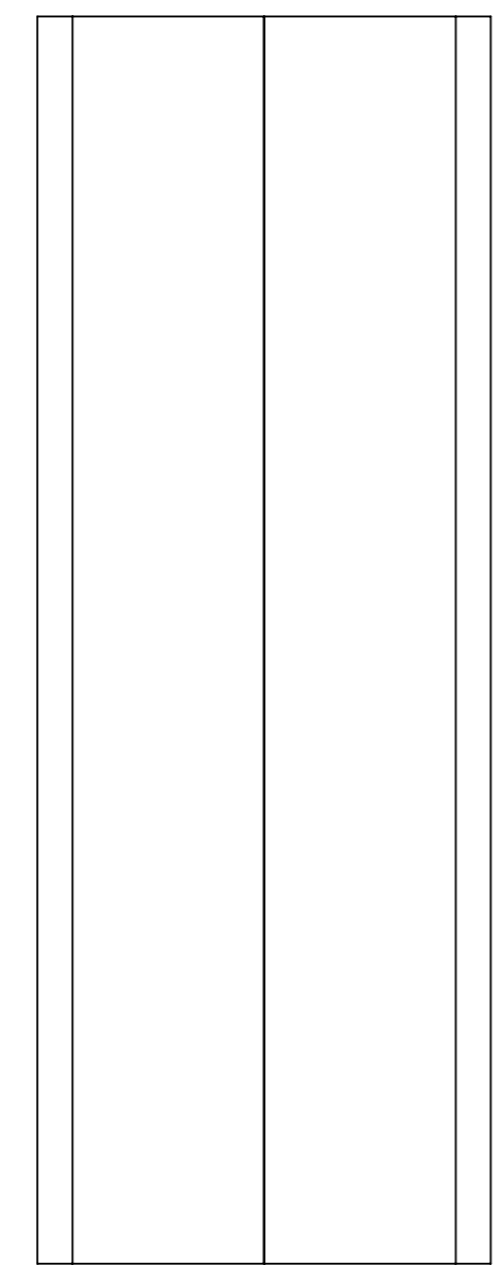

SURFACE-20

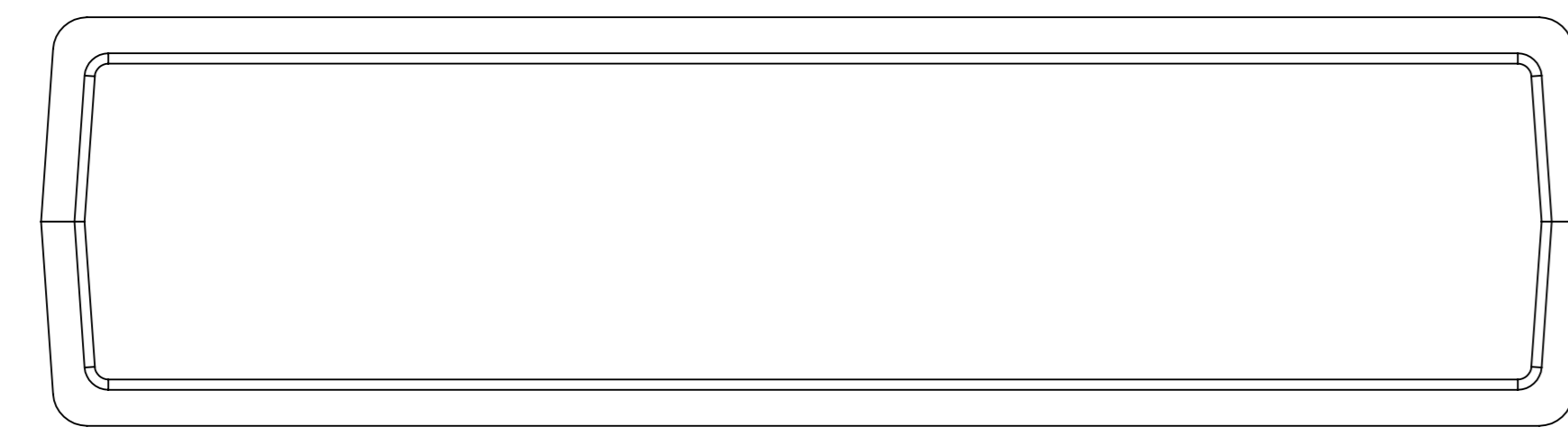

SURFACE-18

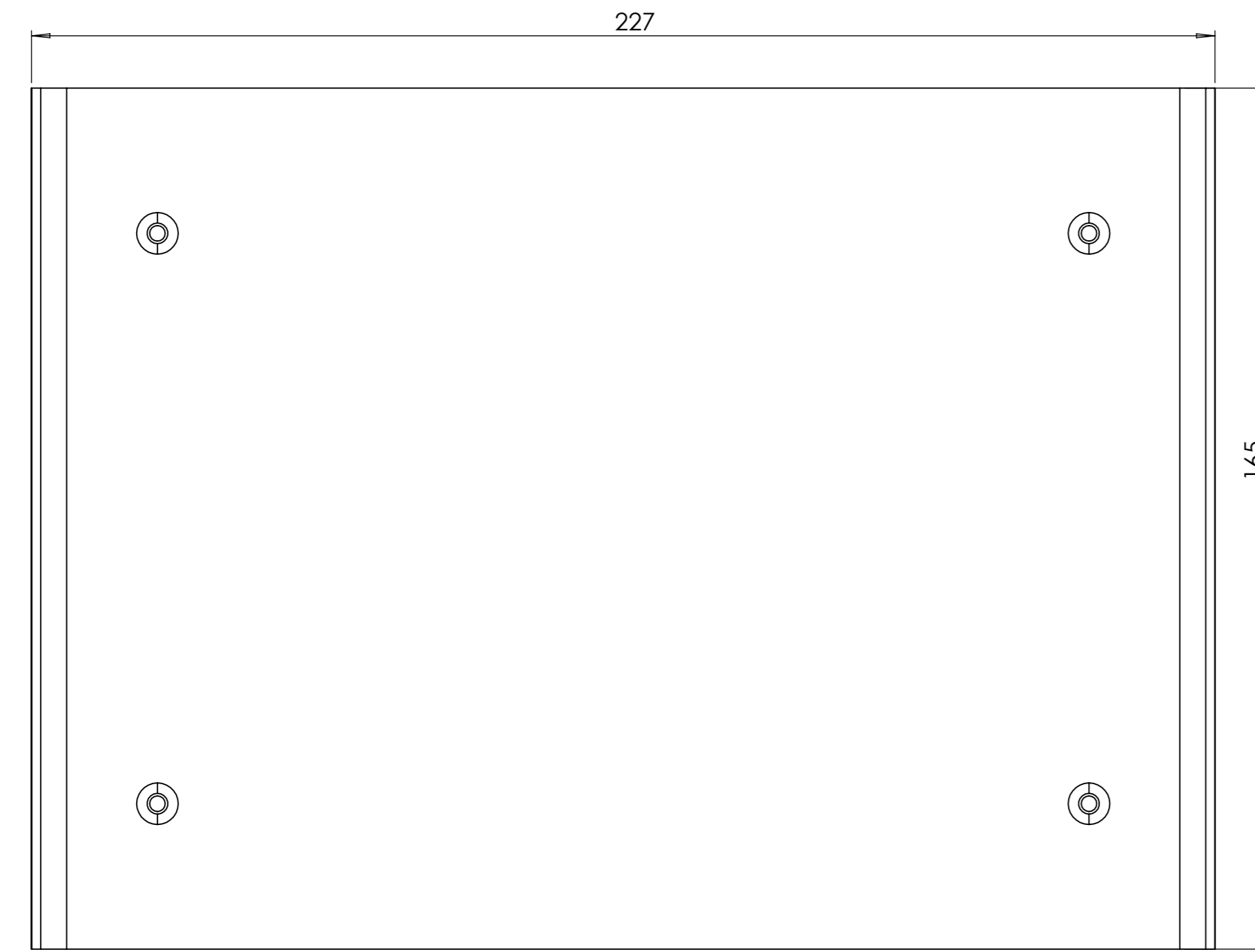

SURFACE-22

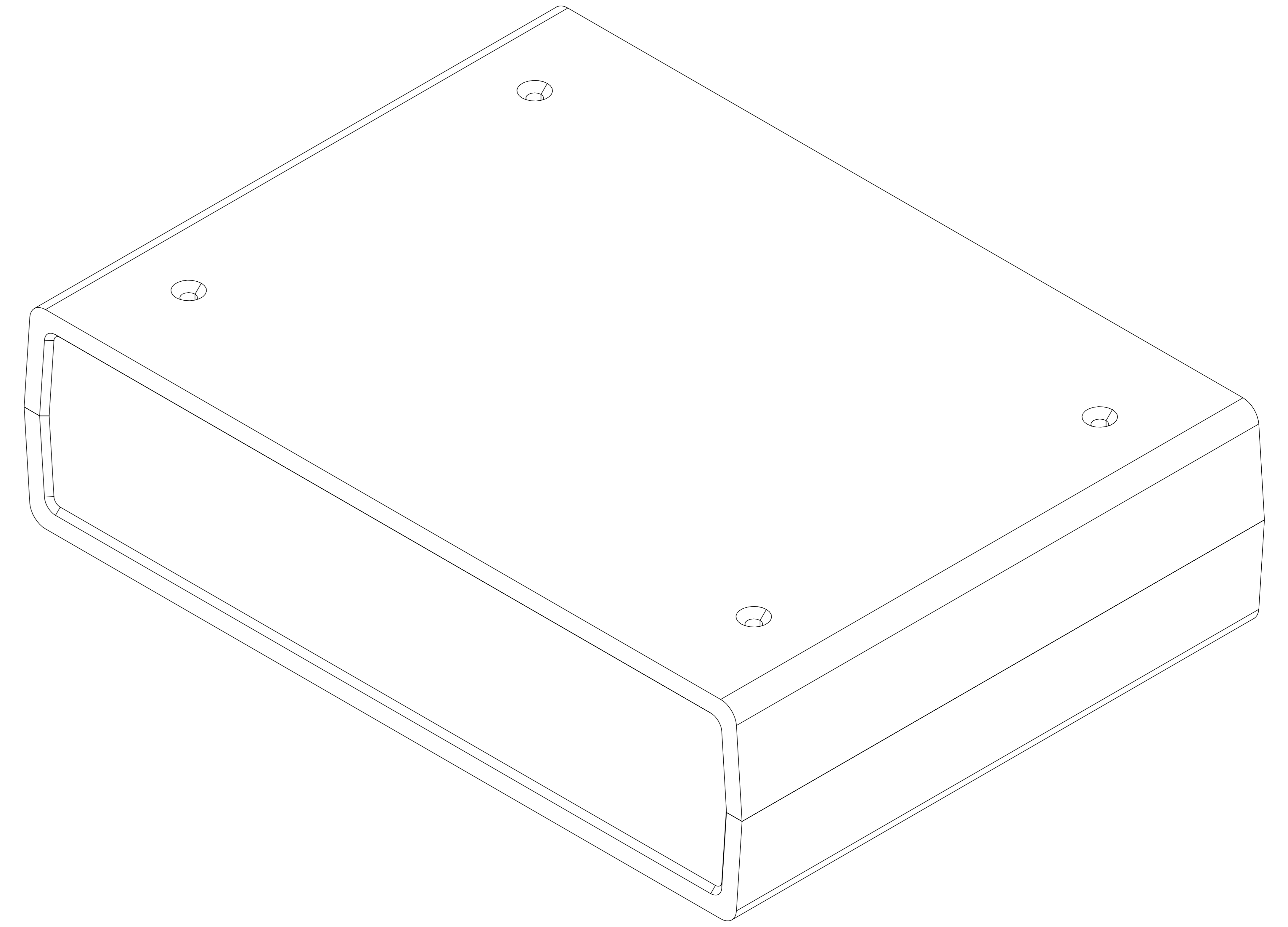
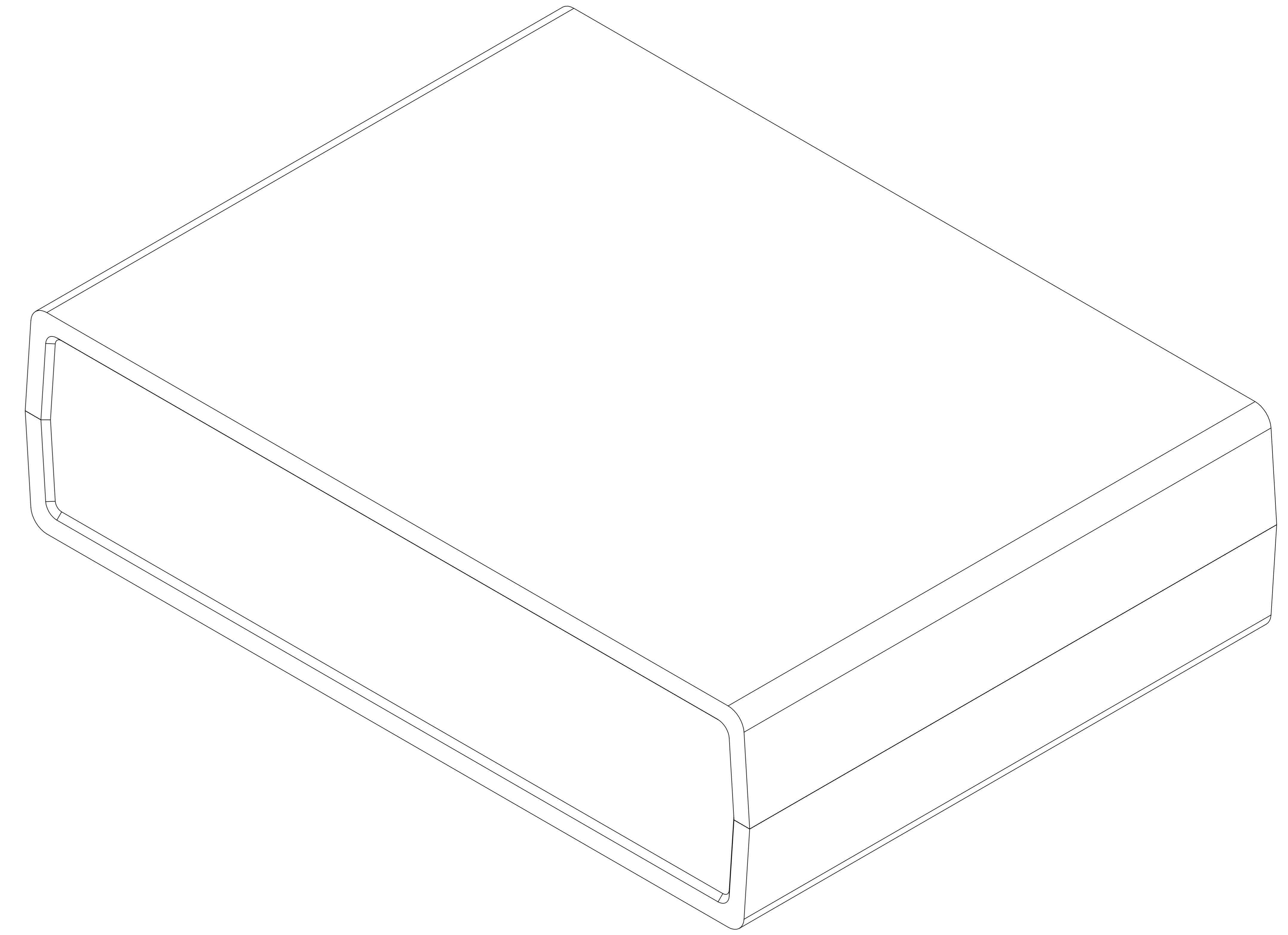

REV. NO	DATE	REVISED BY	DESCRIPTION OF CHANGE
 <b>ALTINKAYA</b> Electronic Enclosures & Components			www.altinkaya.com
			Customer Name :
Altinkaya Ref :		Customer Ref. : DT-220-0-0	
DRAWN	NAME	DATE	Drawn From:
CHECKED	Y.YEL	15.10.2024	Material:
DIMENSIONAL TOLERANCES UNLESS OTHERWISE SPECIFIED (DIN7168)			Weight:
±0,1	±0,1	±0,2	±0,3
0,5-3mm	3-6mm	6-30mm	30-120mm
UNITS: mm			Dimension(mm)
m (medium)			