

KESIT A-A

PROPRIETARY AND CONFIDENTIAL THE INFORMATION CONTAINED IN THIS DRAWING IS THE SOLE PROPERTY OF ALTINKAYA ENCLOSURES. ANY REPRODUCTION IN PART OR AS A WHOLE WITHOUT THE WRITTEN PERMISSION OF ALTINKAYA ENCLOSURES IS PROHIBITED.			ARTICLE NO:	REVISION:
DİKKAT: BU RESİM VE ÜRÜN ÖNCEDEN HABER VERİLMEKSİZİN DEĞİŞTİRİLEBİLİR RESİM ÇİZİLMİŞ HATASIZ OLMASINA ÇALIŞILMASINA RAĞMEN RESİMDE HATALAR BULUNABİLİR. RESİMDEKİ HATALARDAN DOLAYI OLUŞABİLECEK ZARARLAR İÇİN ALTINKAYA HIÇ BİR SORUMLULUK KABUL ETMEZ. BÜTÜN ÖLÇÜLER KULLANILMADAN ÖNCE ÜRETİLMİŞ GERÇEK NUMUNEDEN KONTROL EDİLMELİDİR.			CONTACT: www.altinkaya.com	
DRAWN	Dursun Dağdemir	31.10.24		
CHECKED	Ali Altınşik	31.10.24	COMMENTS: This drawing is subject to technical modification without prior notice. Typographical and other errors do not justify any claims for damages. All dimensions should be verified using an actual produced part.	
MATERIAL: ABS UL94 V0			DWG NO:	A2
WEIGHT:			SCALE: 1:1	SHEET 1 OF 1
TITLE:			HH-2020 Handheld Enclosure	
			HH-2020-0-0	

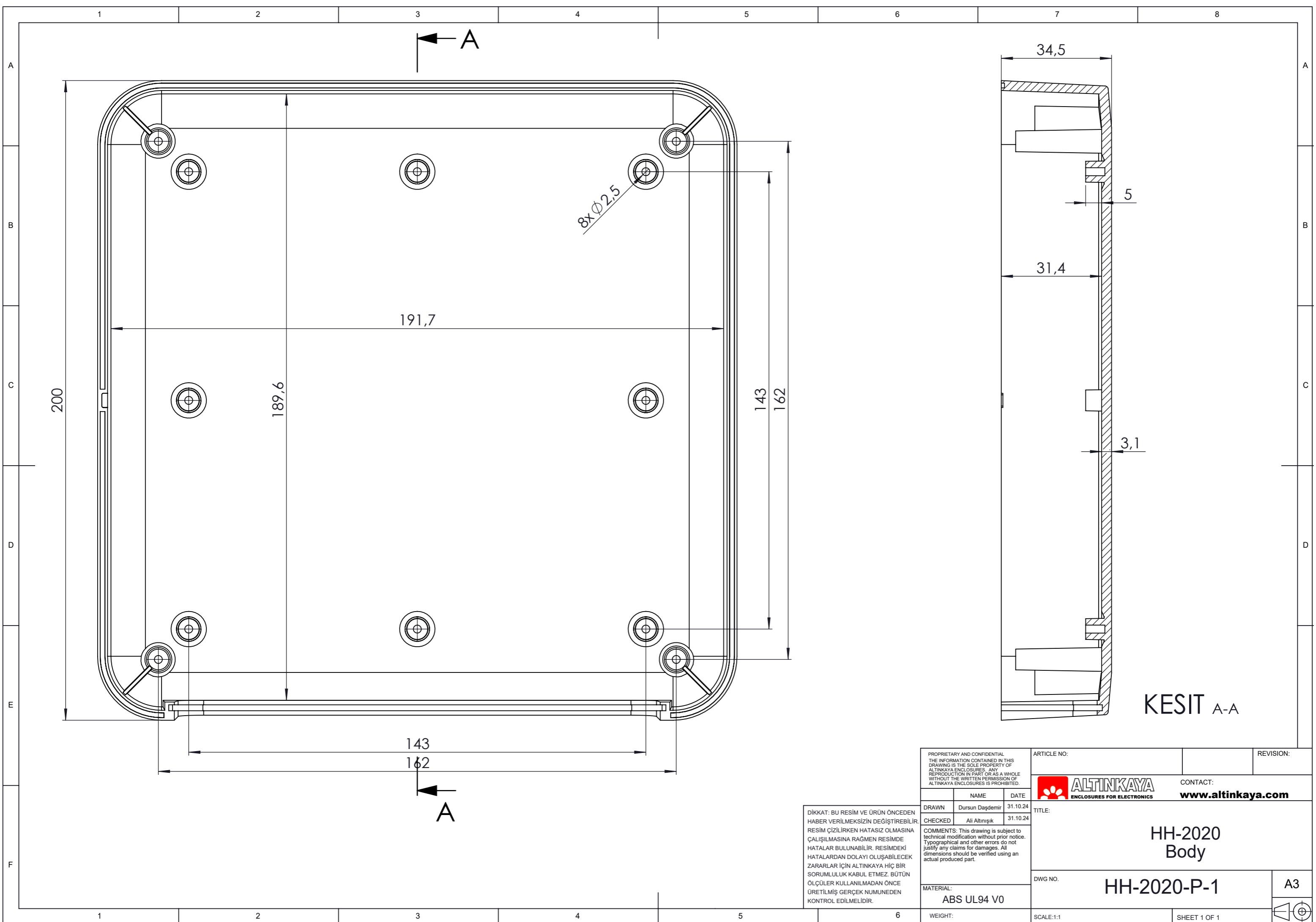

8xØ2.5

34,5

5

31,4

3,1

KESIT A-A

PROPRIETARY AND CONFIDENTIAL THE INFORMATION CONTAINED IN THIS DRAWING IS THE SOLE PROPERTY OF ALTINKAYA ENCLOSURES. ANY REPRODUCTION IN PART OR AS A WHOLE WITHOUT THE WRITTEN PERMISSION OF ALTINKAYA ENCLOSURES IS PROHIBITED.		ARTICLE NO:	REVISION:
DRAWN Dursun Daşdemir 31.10.24 CHECKED Ali Altınışık 31.10.24		 CONTACT: www.altinkaya.com	
DİKKAT: BU RESİM VE ÜRÜN ÖNCEDEN HABER VERİLMEKSİZİN DEĞİŞTİREBİLİR. RESİM ÇİZİLİRKEN HATASIZ OLMASINA ÇALIŞILMASINA RAĞMEN RESİMDE HATALARDAN DOLAYI OLUŞABİLECEK ZARARLAR İÇİN ALTINKAYA HiÇ BİR SORUMLULUK KABUL ETMEZ. BÜTÜN ÖLÇÜLER KULLANILMADAN ÖNCE ÜRETİLMİŞ GERÇEK NUMUNEDEN KONTROL EDİLMELİDİR.		TITLE: <h2 style="text-align: center;">HH-2020 Body</h2>	
MATERIAL: ABS UL94 V0		DWG NO:	A3
WEIGHT:		SCALE:1:1	SHEET 1 OF 1

DİKKAT: BU RESİM VE ÜRÜN ÖNCEDEN
 HABER VERİLMEKSİZİN DEĞİŞTİREBİLİR.
 RESİM ÇİZİLİRKEN HATASIZ OLMASINA
 ÇALIŞILMASINA RAĞMEN RESİMDE
 HATALARDAN DOLAYI OLUŞABİLECEK
 ZARARLAR İÇİN ALTINKAYA HiÇ BİR
 SORUMLULUK KABUL ETMEZ. BÜTÜN
 ÖLÇÜLER KULLANILMADAN ÖNCE
 ÜRETİLMİŞ GERÇEK NUMUNEDEN
 KONTROL EDİLMELİDİR.

HH-2020
Body

HH-2020-P-1

A3



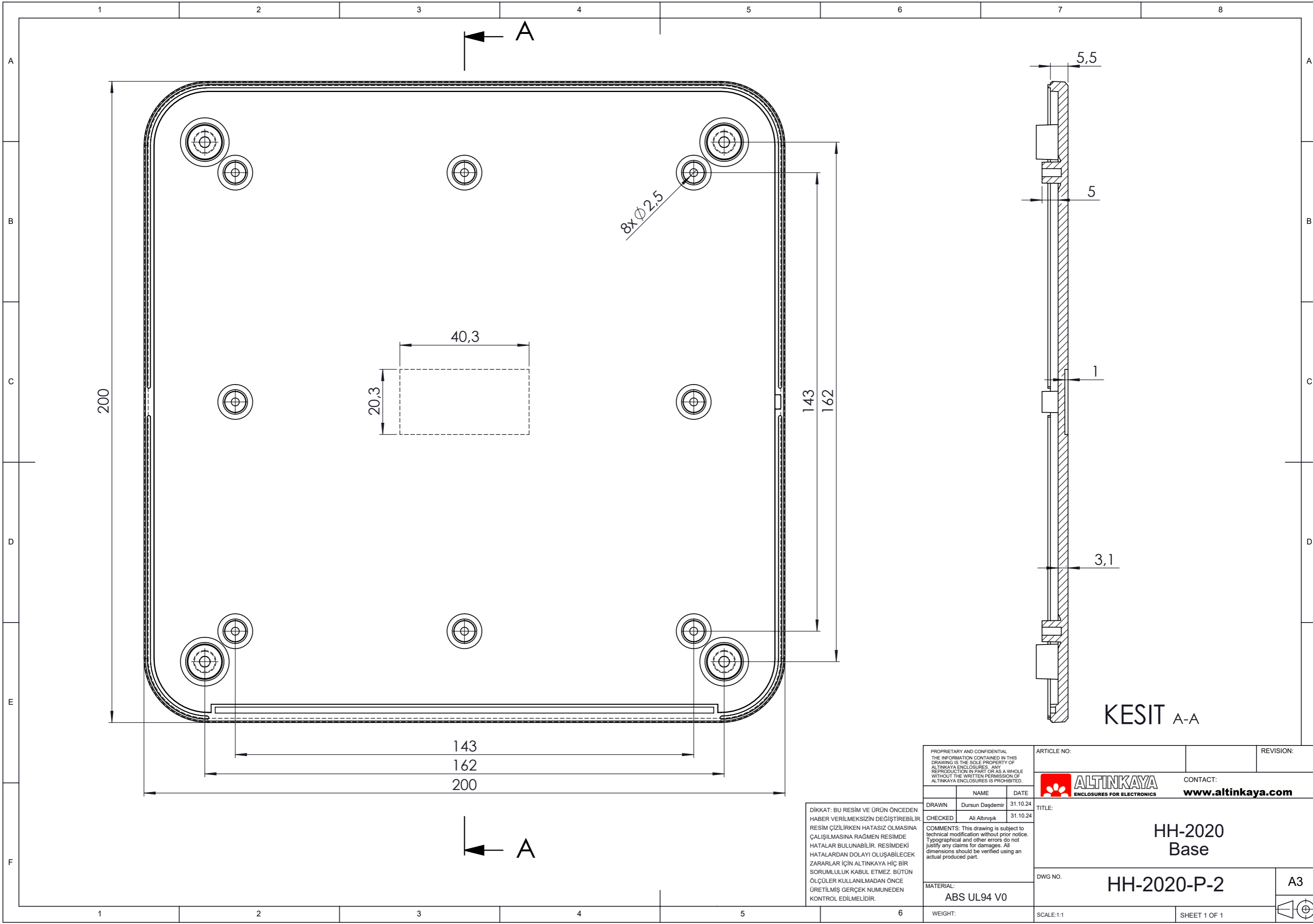

8xØ2.5

200

40,3
20,3

143
162

143
162
200

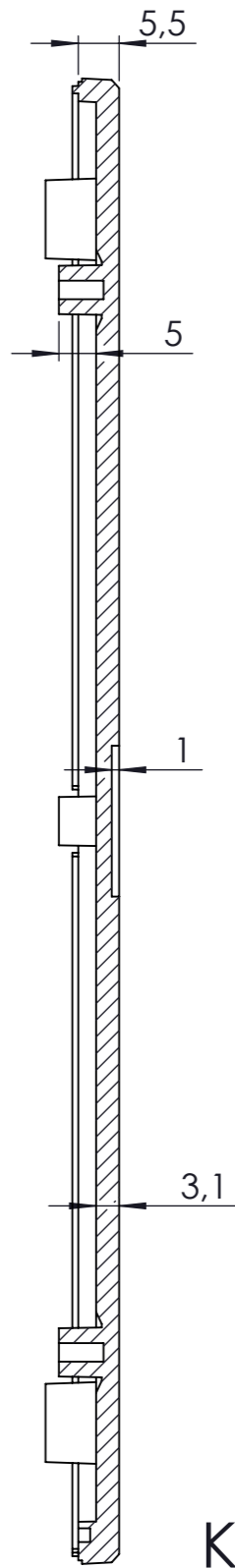

KESIT A-A

DİKKAT: BU RESİM VE ÜRÜN ÖNCEDEN HABER VERİLMEKSİZİN DEĞİŞTİREBİLİR. RESİM ÇİZİLİRKEN HATASIZ OLMASINA ÇALIŞILMASINA RAĞMEN RESİMDEKİ HATALARDAN DOLAYI OLUŞABİLECEK ZARARLAR İÇİN ALTINKAYA HiÇ BİR SORUMLULUK KABUL ETMEZ. BÜTÜN ÖLÇÜLER KULLANILMADAN ÖNCE ÜRETİLMİŞ GERÇEK NUMUNEDEN KONTROL EDİLMELİDİR.

<small>PROPRIETARY AND CONFIDENTIAL. THE INFORMATION CONTAINED IN THIS DRAWING IS THE SOLE PROPERTY OF ALTINKAYA ENCLOSURES. ANY REPRODUCTION IN PART OR AS A WHOLE WITHOUT THE WRITTEN PERMISSION OF ALTINKAYA ENCLOSURES IS PROHIBITED.</small>		ARTICLE NO:	REVISION:						
<table border="1"> <tr> <th>NAME</th> <th>DATE</th> </tr> <tr> <td>DRAWN Dursun Daşdemir</td> <td>31.10.24</td> </tr> <tr> <td>CHECKED Ali Altınışık</td> <td>31.10.24</td> </tr> </table>	NAME	DATE	DRAWN Dursun Daşdemir	31.10.24	CHECKED Ali Altınışık	31.10.24		CONTACT: www.altinkaya.com	
NAME	DATE								
DRAWN Dursun Daşdemir	31.10.24								
CHECKED Ali Altınışık	31.10.24								
COMMENTS: This drawing is subject to technical modification without prior notice. Typographical and other errors do not justify any claims for damages. All dimensions should be verified using an actual produced part.		TITLE: HH-2020 Base							
MATERIAL: ABS UL94 V0		DWG NO:	A3						
WEIGHT:		SCALE:1:1	SHEET 1 OF 1						

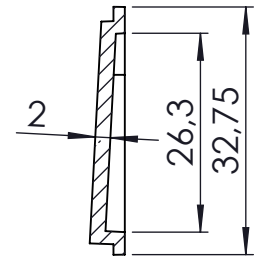
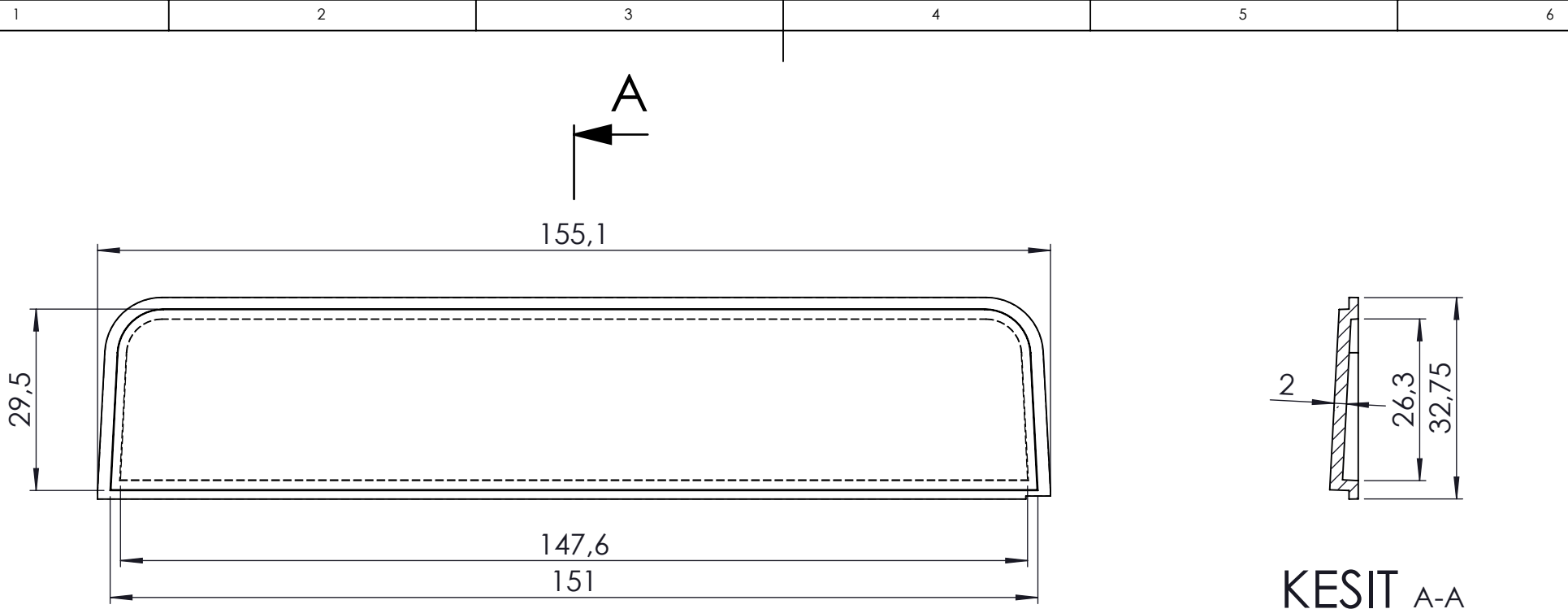

KESIT A-A

NAME	DATE	ARTICLE NO:	REVISION:	TITLE:
DRAWN	Dursun Daşdemir	31.10.24		HH-2020 Panel
CHECKED	Ali Altınışık	31.10.24		
 www.altinkaya.com		COMMENTS: This drawing is subject to technical modification without prior notice. Typographical and other errors do not justify any claims for damages. All dimensions should be verified using an actual produced part.		DWG NO.
PROPRIETARY AND CONFIDENTIAL THE INFORMATION CONTAINED IN THIS DRAWING IS THE SOLE PROPERTY OF ALTINKAYA ENCLOSURES. ANY REPRODUCTION IN PART OR AS A WHOLE WITHOUT THE WRITTEN PERMISSION OF ALTINKAYA ENCLOSURES IS PROHIBITED.		DİKKAT: BU RESİM VE ÜRÜN ÖNCEDEN HABER VERİLMEKSİZİN DEĞİŞTİRİLEBİLİR. RESİM ÇİZİLRKEN HATASIZ OLMASINA ÇALIŞILMASINA RAĞMEN RESİMDE HATALAR BULUNABİLİR. RESİMDEKİ HATALARDAN DOLAYI OLUŞABİLECEK ZARARLAR İÇİN ALTINKAYA HİÇ BİR SORUMLULUK KABUL ETMEZ. BÜTÜN ÖLÇÜLER KULLANILMADAN ÖNCE ÜRETİLMİŞ GERÇEK NUMUNEDEN KONTROL EDİLMELİDİR.		HH-2020-P-3
MATERIAL: ABS UL94 V0		WEIGHT:		A4
		SCALE:1:1		SHEET 1 OF 1

