

BASE: 6 SURFACE

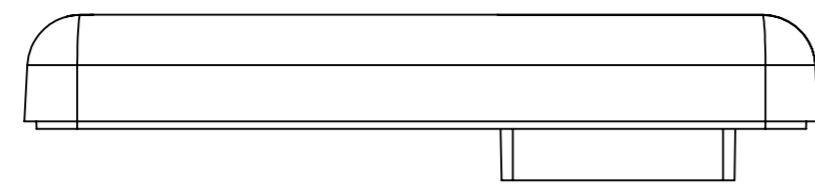

SURFACE-1

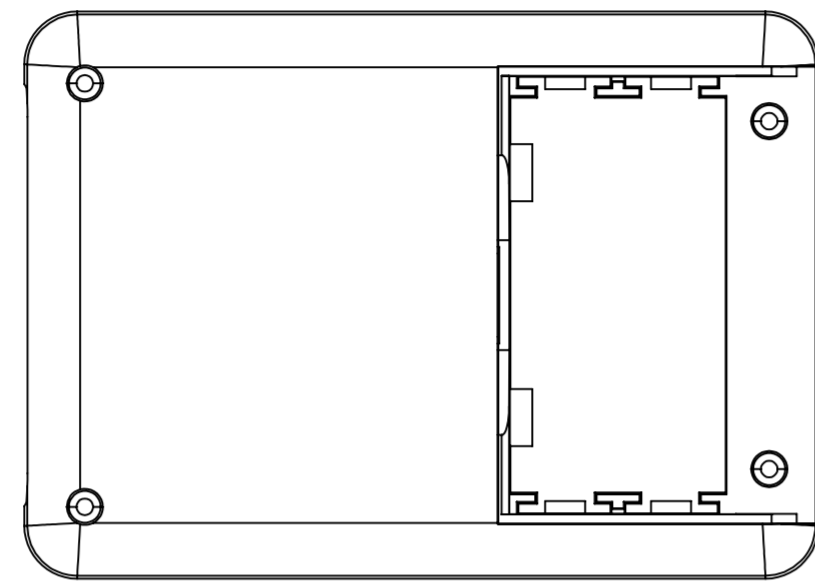

SURFACE-5

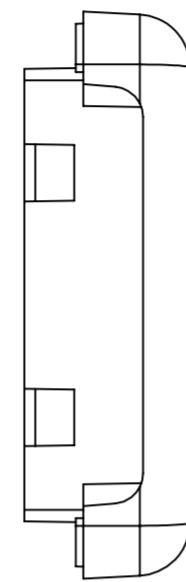

SURFACE-4

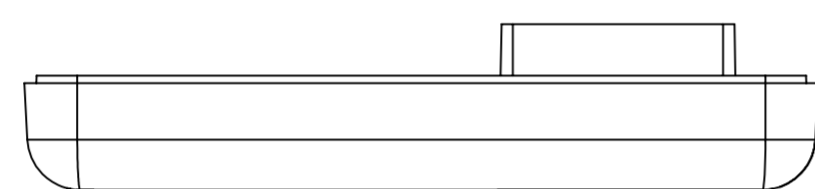

SURFACE-2

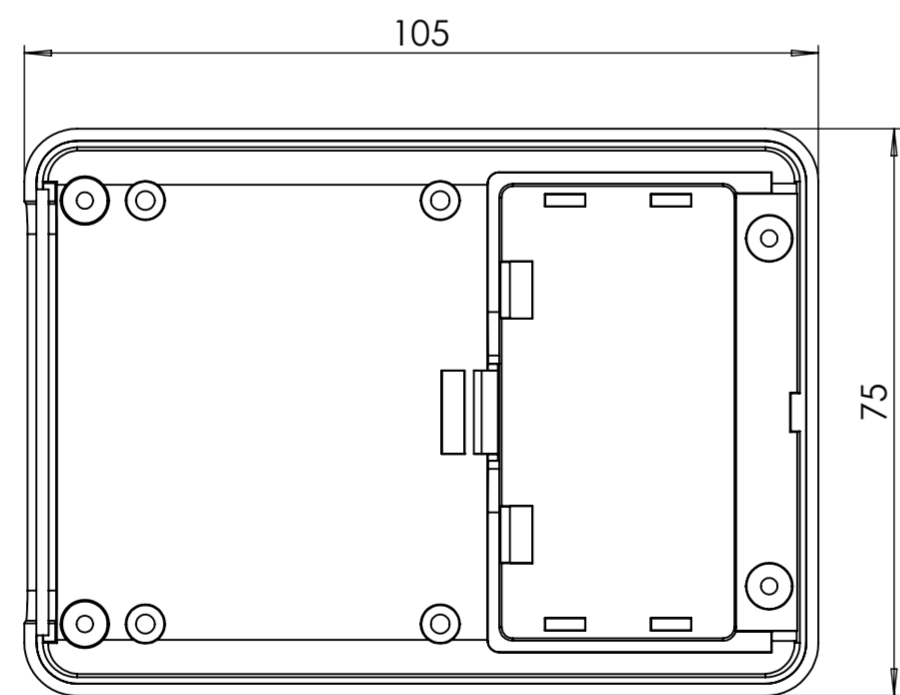

SURFACE-6 (INSIDE)

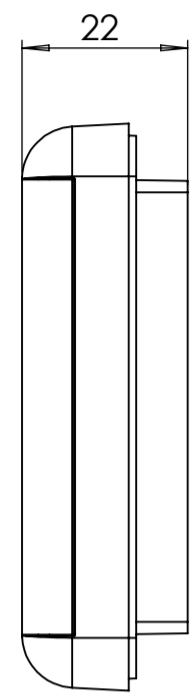

SURFACE-3

COVER: 6 SURFACE

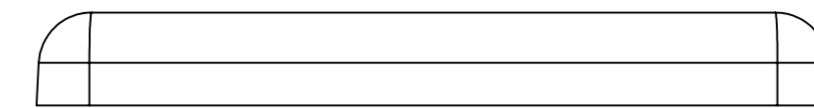

SURFACE-7

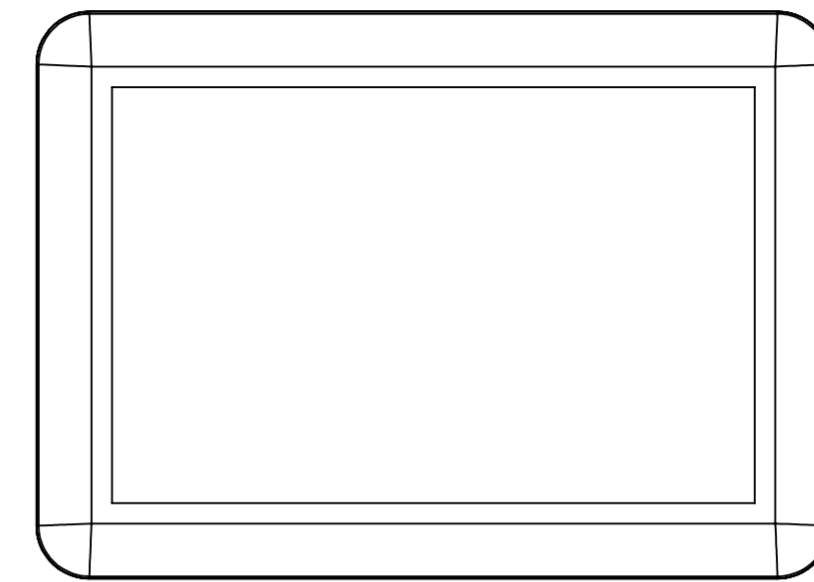

SURFACE-11



SURFACE-10

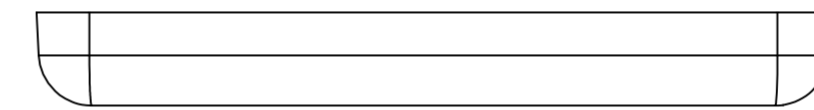

SURFACE-8

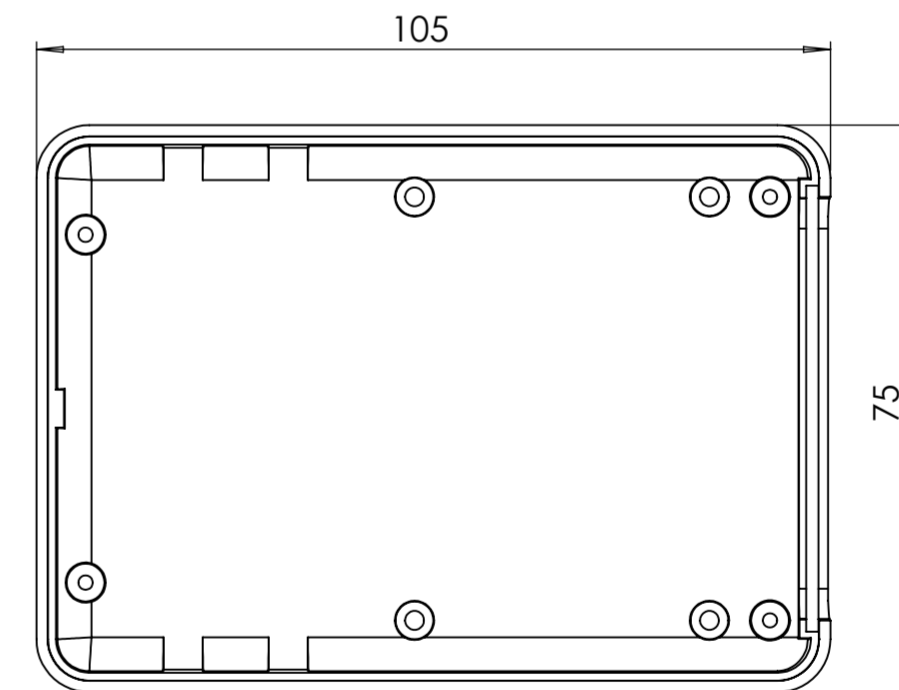

SURFACE-12 (INSIDE)



SURFACE-9

PANEL: 2 SURFACE

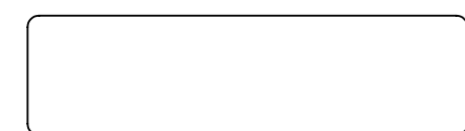
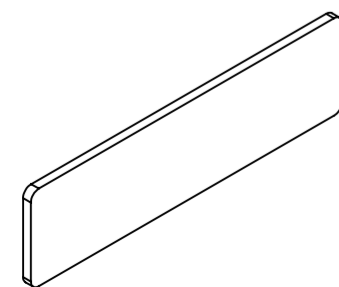

SURFACE-13

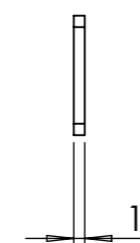

SURFACE-14 (INSIDE)

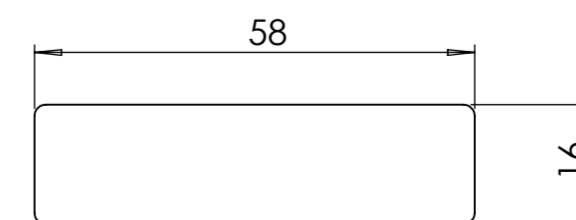

REV. NO	DATE	REVISED BY	DESCRIPTION OF CHANGE
ALTINKAYA Electronic Enclosures & Components			
Customer Name:		Customer Ref.:	
Allinkaya Ref.:		Part Name: HK-052-0-0	
DRAWN	NAME	DATE	Drawn From:
CHECKED	Y.YEL	18.09.2024	Weight:
DIMENSIONAL TOLERANCES (UNLESS OTHERWISE SPECIFIED) (EN 7148)			
	0,5-3mm	3-6mm	6-30mm
	±0,1	±0,1	±0,2
			±0,3
			±0,5
			mm (medium)

HH-052 MACHINED TOGETHER

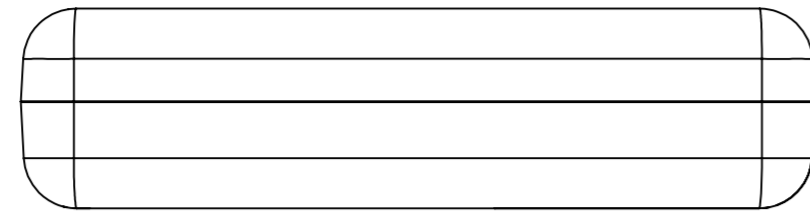

SURFACE-15

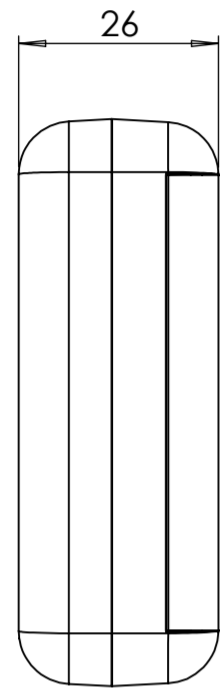

SURFACE-17

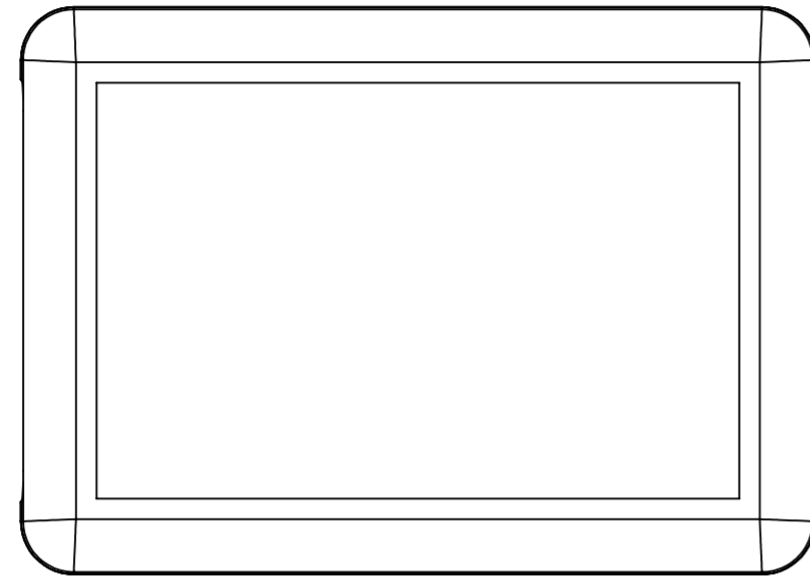

SURFACE-19

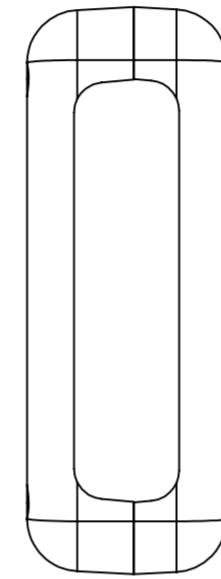

SURFACE-18

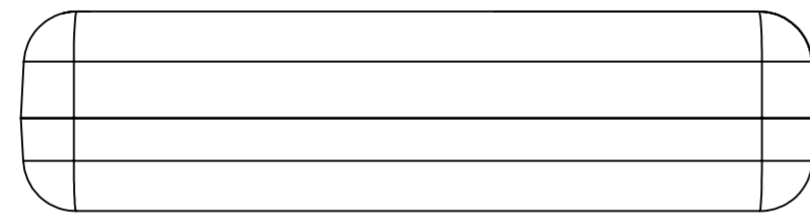
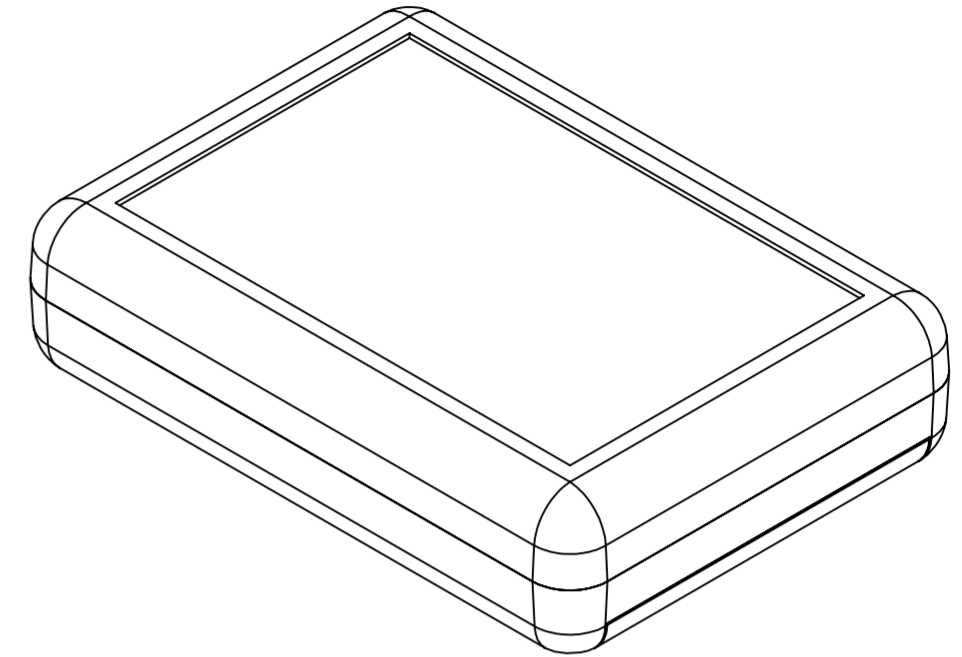

SURFACE-16

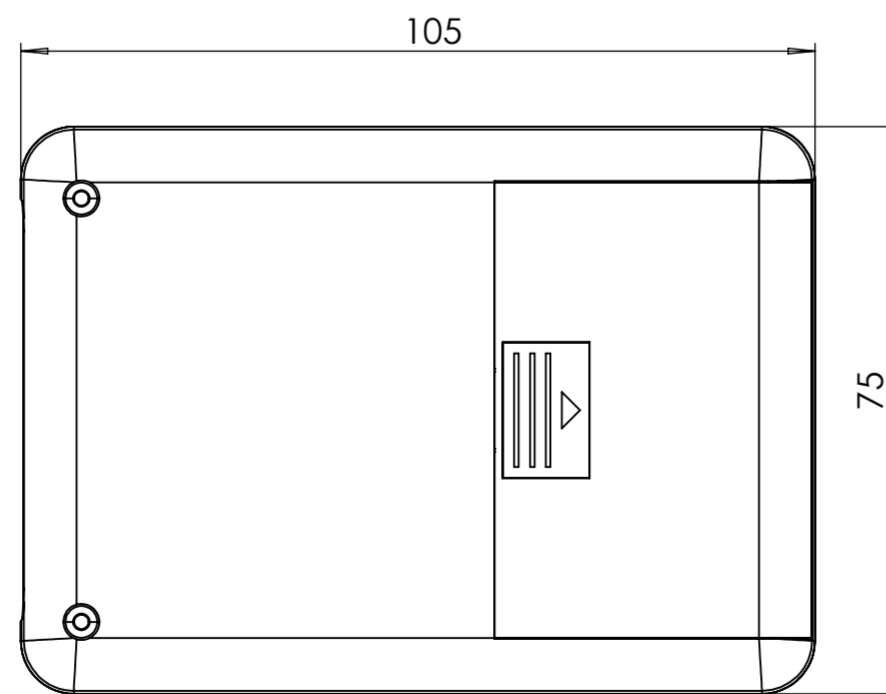

SURFACE-20

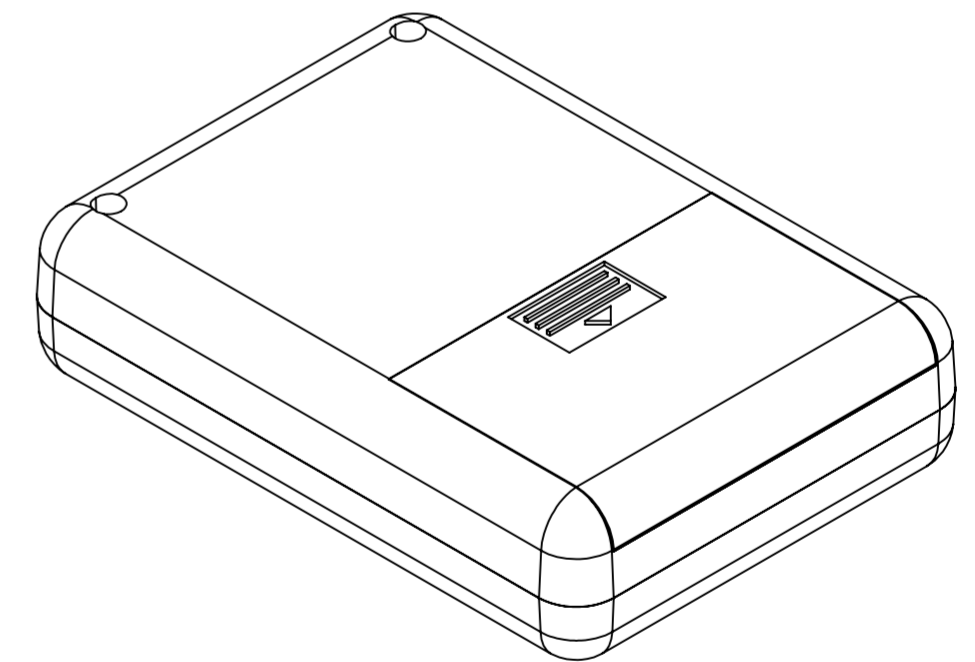

REV. NO	DATE	REVISED BY	DESCRIPTION OF CHANGE
 ALTINKAYA Electronic Enclosures & Components			www.altinkaya.com
Customer Name:		Customer Ref.:	
Allinkaya Ref.:		Part Name: HH-052-0-0	
DRAWN	NAME	DATE	Drawn From:
CHECKED	Y.YEL	18.09.2024	Weight:
DIMENSIONAL TOLERANCES UNLESS OTHERWISE SPECIFIED (DIN 7146)			
	0,5-3mm	3-6mm	6-30mm
	±0,1	±0,1	±0,2
			±0,3
			±0,5
			mm (medium)

SCALE: 1:1

SHEET 2 OF 2

A2