

BASE: 6 SURFACE

COVER: 6 SURFACE

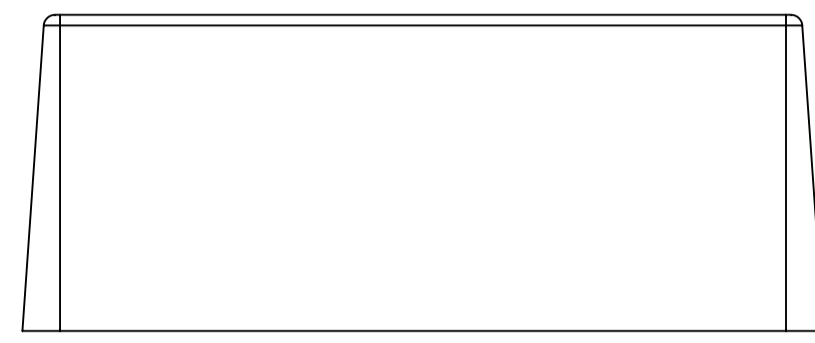

SURFACE-1

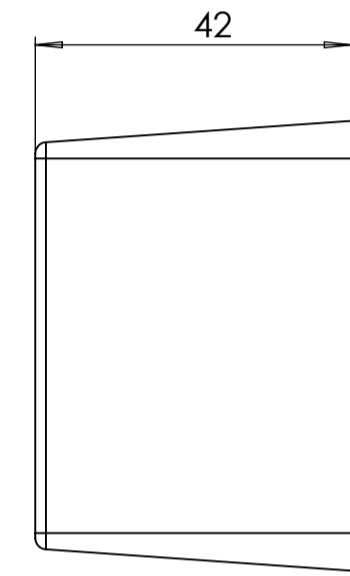

SURFACE-3

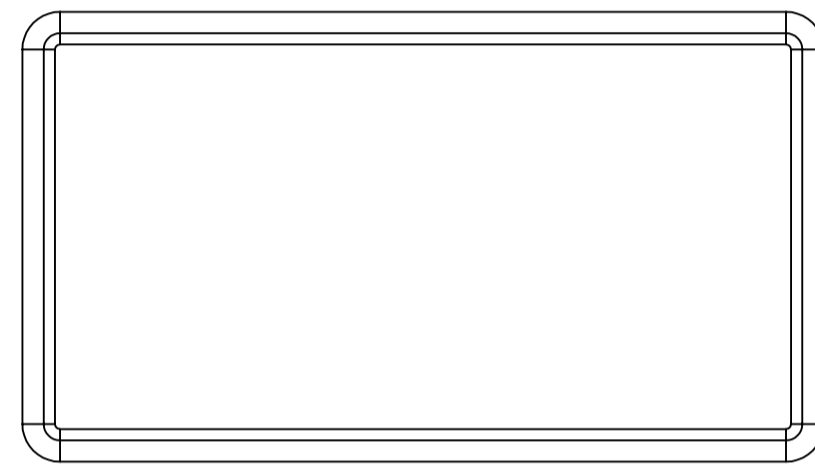

SURFACE-5

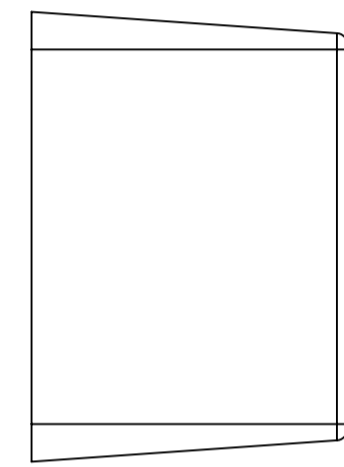

SURFACE-4

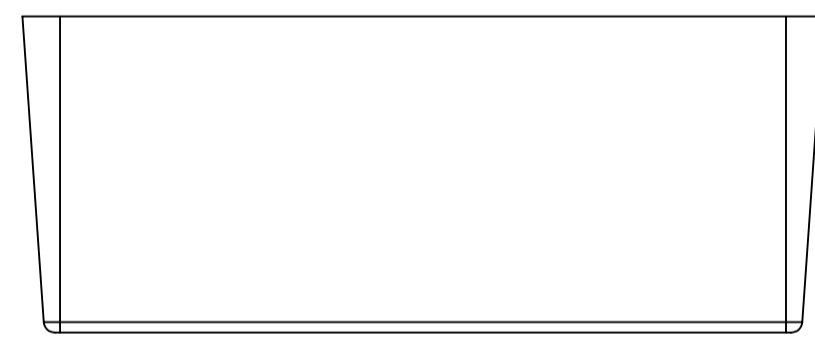

SURFACE-2

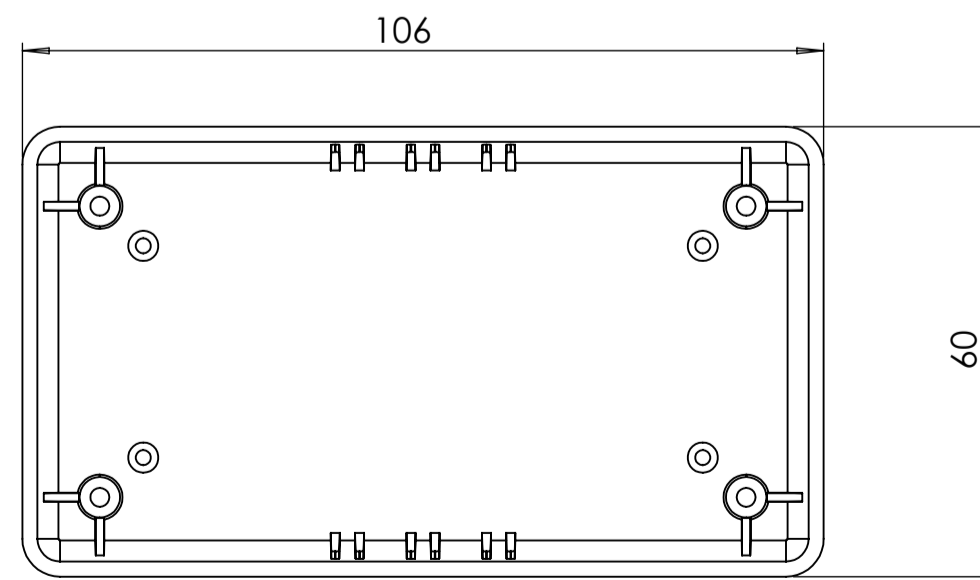
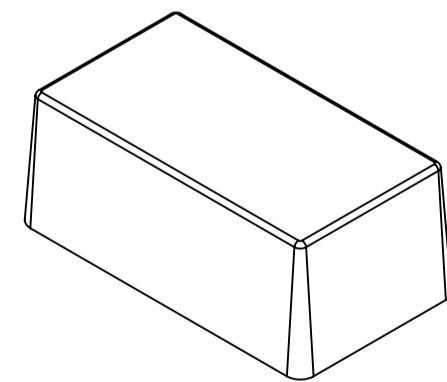

SURFACE-6 (INSIDE)

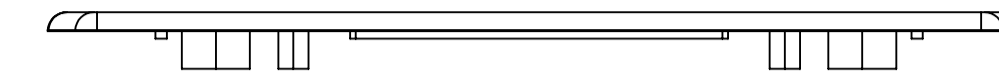

SURFACE-7

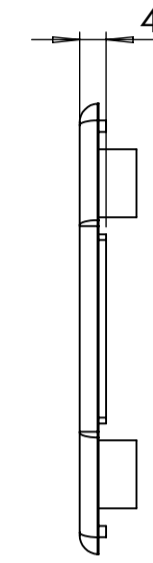

SURFACE-9

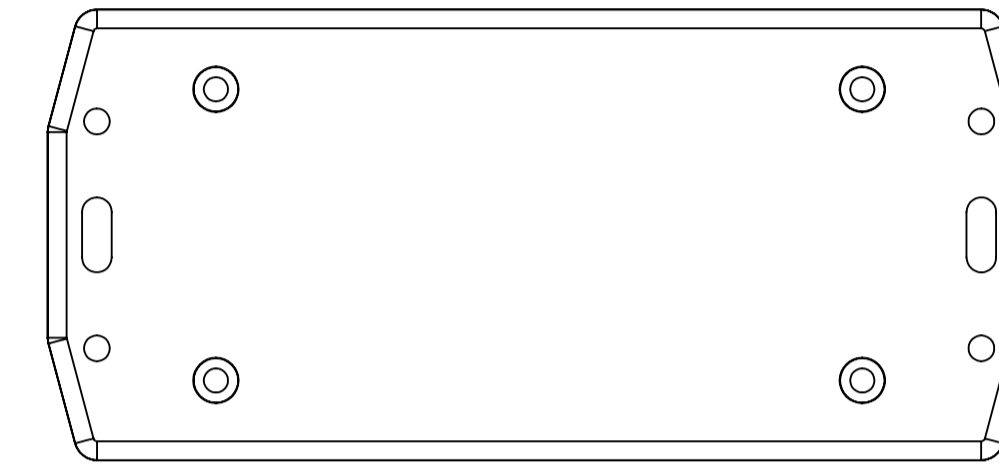

SURFACE-11

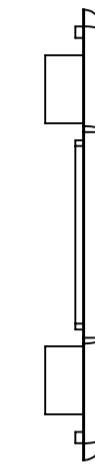

SURFACE-10

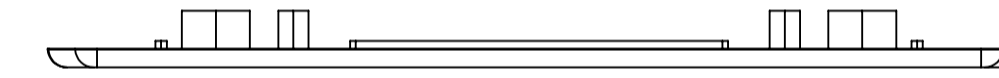

SURFACE-8

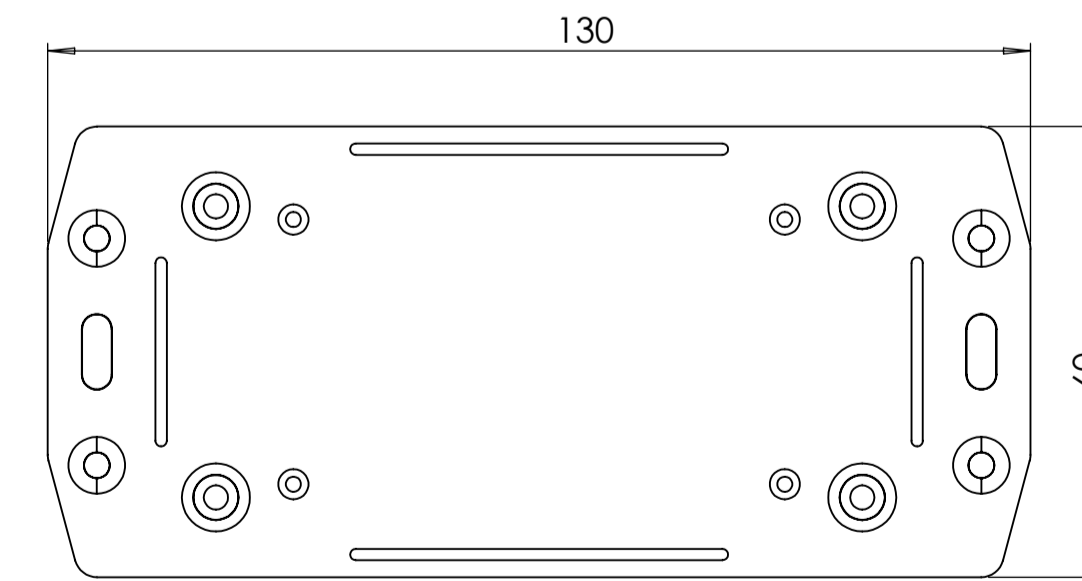
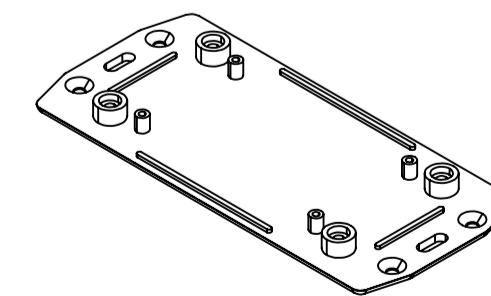

SURFACE-12 (INSIDE)

REV. NO.	DATE	REVISED BY	DESCRIPTION OF CHANGE
			www.altinkaya.com
Customer Name:		Customer Ref.:	
Altinkaya Ref.:		Part Name: PR-080-A	
DRAWN	NAME	DATE	Drawn From:
CHECKED	Y.YEL	21.09.2024	Material:
DIMENSIONAL TOLERANCES UNLESS OTHERWISE SPECIFIED:		Weight:	SCALE 1:1 UNIT : mm
[DIN7148]	±0.1	±0.1	±0.2
	±0.3	±0.3	±0.5
			Dimension(mm) m(medium)
			120-400mm
			A1
			SHEET 1 OF 2

PR-080-A IF MACHINED TOGETHER

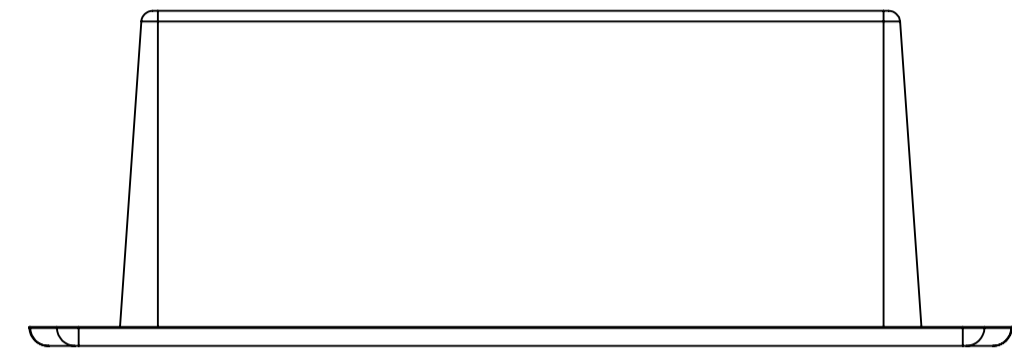

SURFACE-13

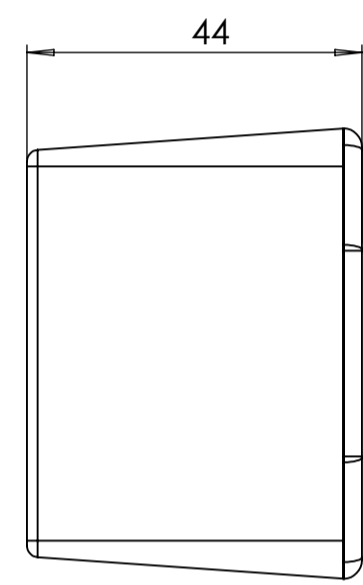

SURFACE-15

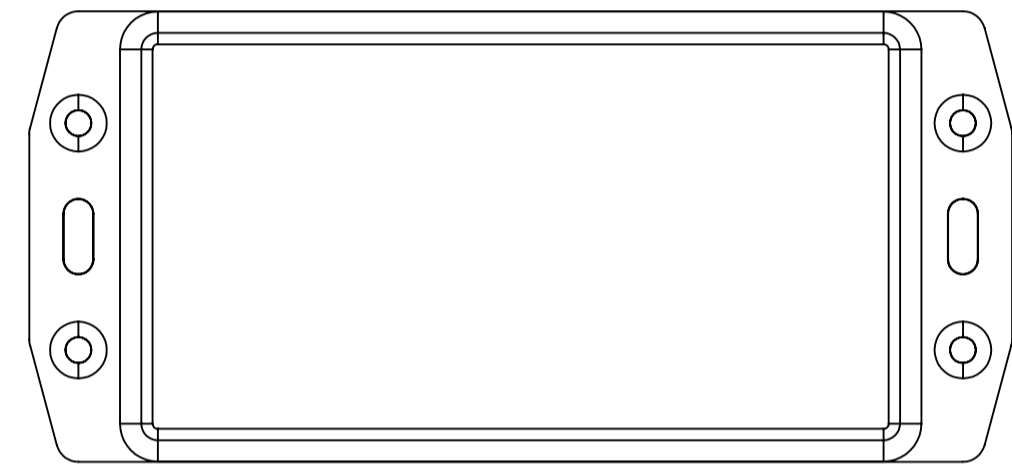

SURFACE-17

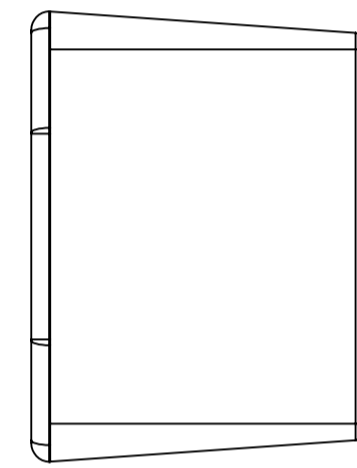

SURFACE-16

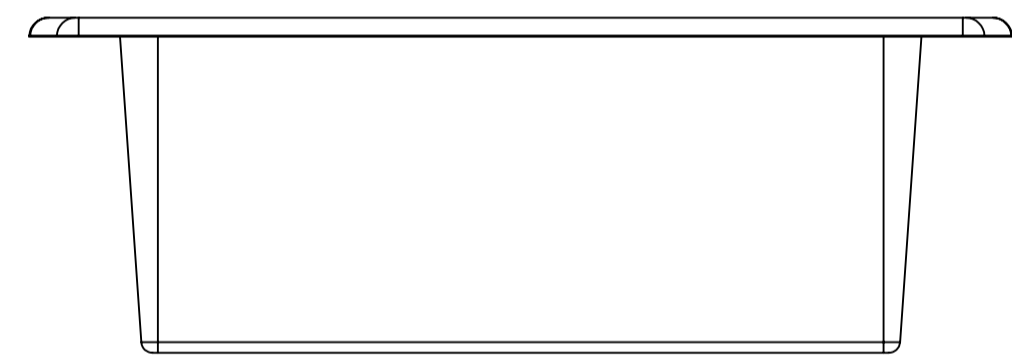

SURFACE-14

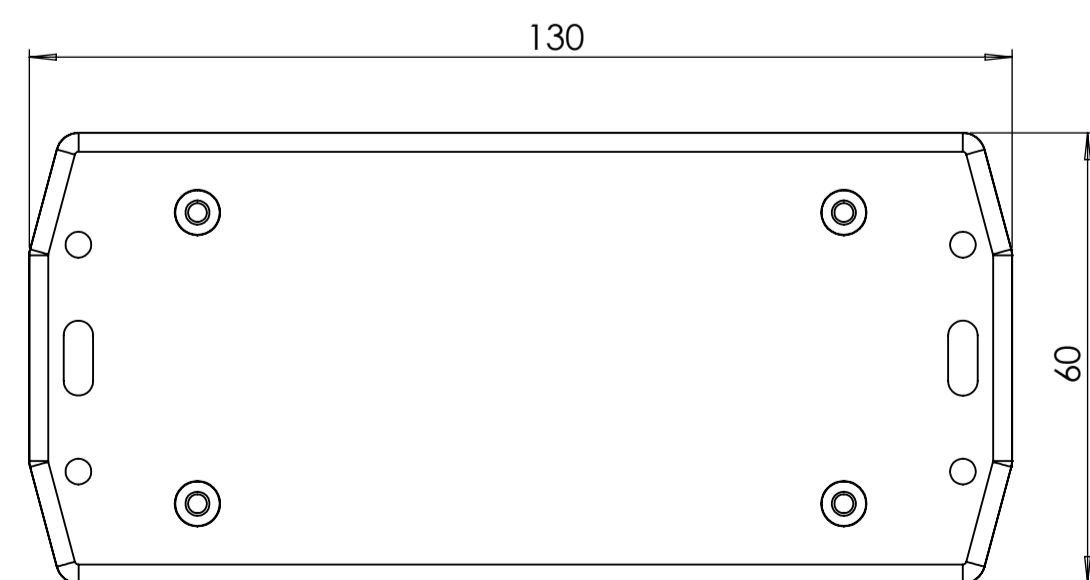

SURFACE-18

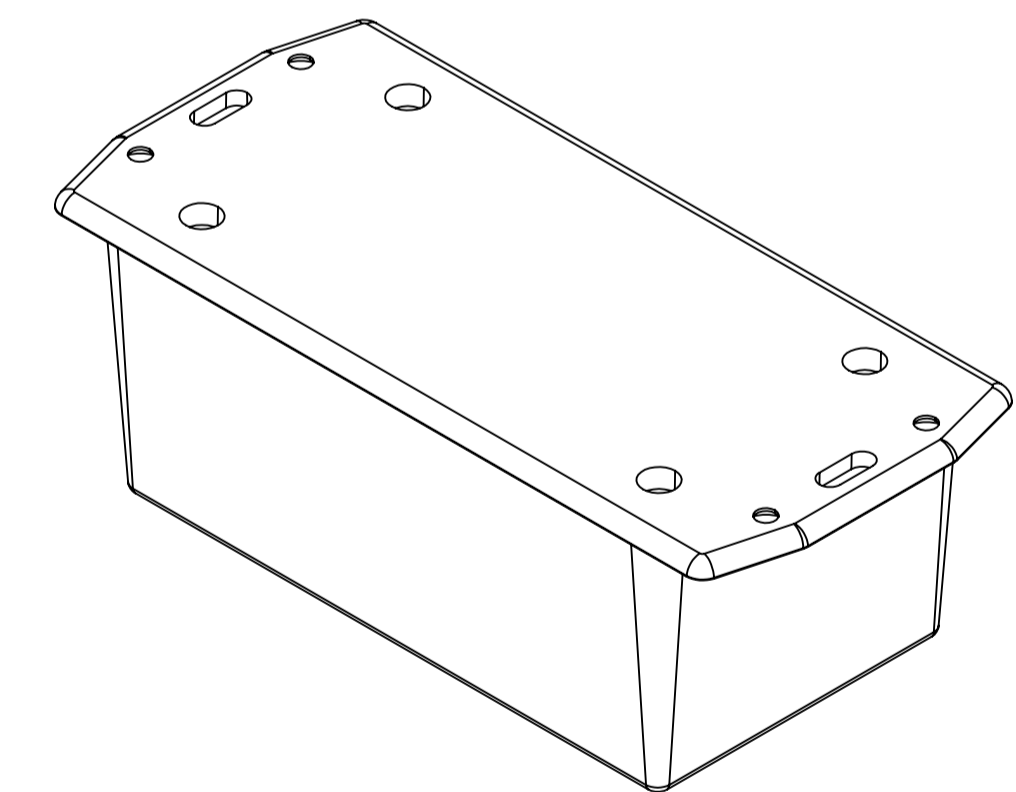
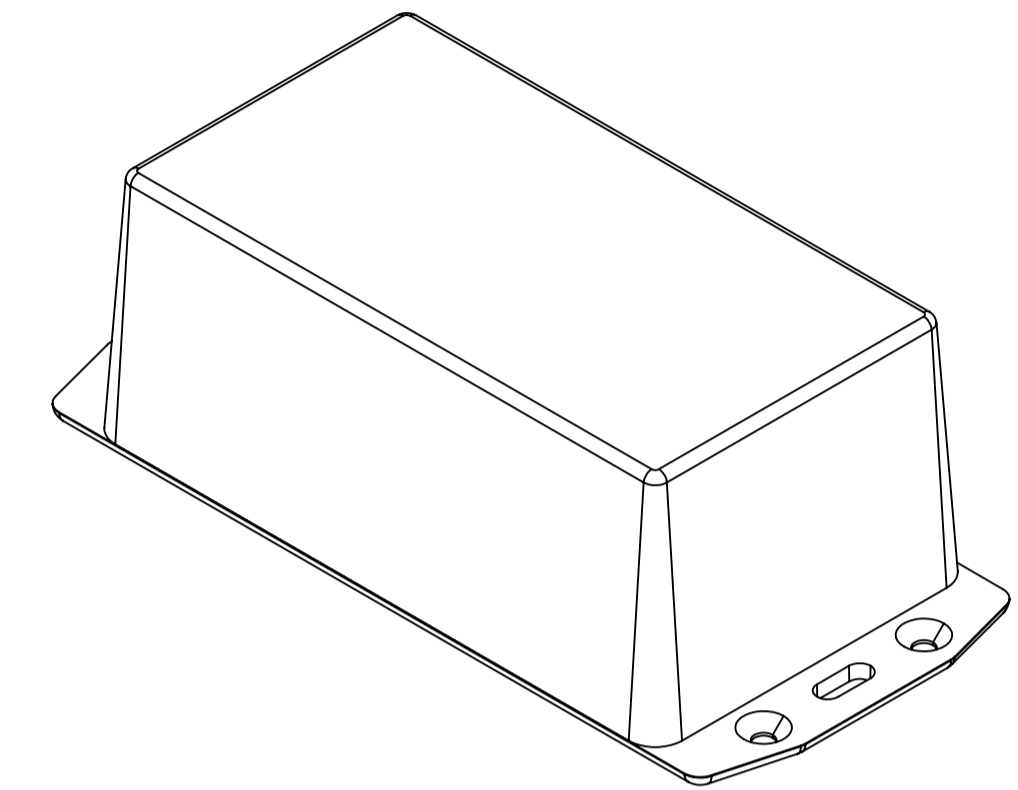

REV. NO.	DATE	REVISED BY	DESCRIPTION OF CHANGE
ALTINKAYA Electronic Enclosures & Components			www.altinkaya.com
Customer Name:		Customer Ref.:	
Altinkaya Ref.:		Part Name: PR-080-A	
DRAWN	NAME	DATE	Drawn From:
CHECKED	Y. YESILOZ	21.09.2024	Material:
DIMENSIONAL TOLERANCES UNLESS OTHERWISE SPECIFIED: (DIN7148)		Weight:	SCALE 1:1 UNIT : mm
±0.1	±0.1	±0.2	±0.3
±0.5	±0.5	±0.5	±0.5
Dimension(mm)			A1
m(medium)			SHEET 2 OF 2