

BASE: 6 SURFACE

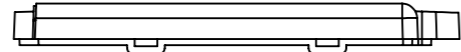

SURFACE-1

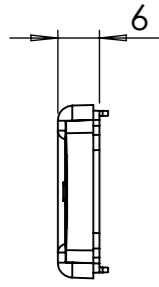

SURFACE-3

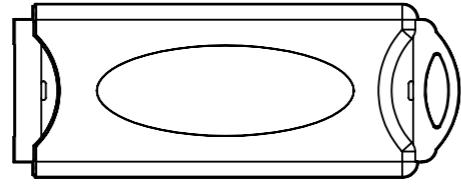

SURFACE-5



SURFACE-4

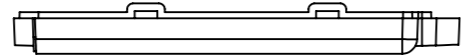

SURFACE-2

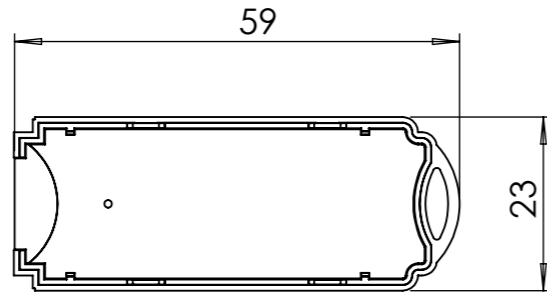

SURFACE-6 (INSIDE)

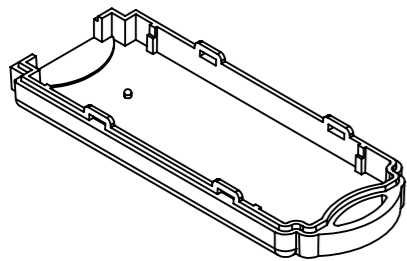

COVER: 6 SURFACE

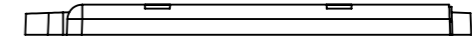

SURFACE-7

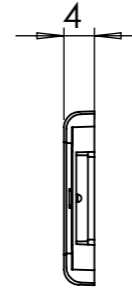

SURFACE-9

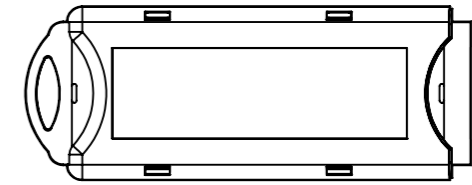

SURFACE-11



SURFACE-10

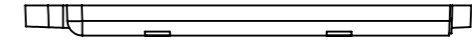

SURFACE-8

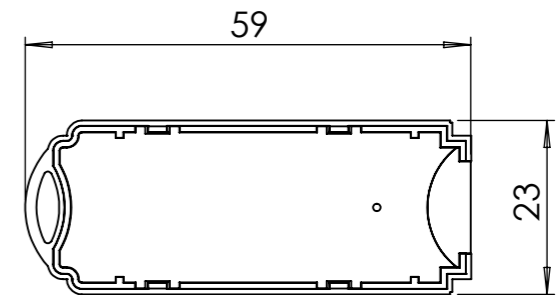

SURFACE-12 (INSIDE)

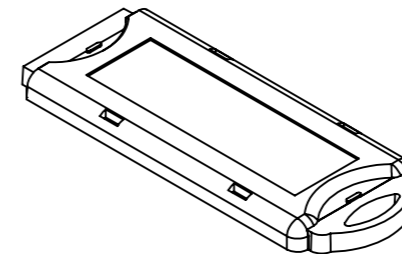

REV. NO	DATE	REVISED BY	DESCRIPTION OF CHANGE					
			ALTINKAYA Electronic Enclosures & Components					
			www.altinkaya.com					
Customer Name:			Customer Ref:					
Altinkaya Ref :			Part Name : HH-019					
NAME			Drawn From:					
DRAWN	S. YESILOZ	13.07.2024	Material :					
CHECKED	Y. YEL	13.07.2024	Weight:					
DIMENSIONAL TOLERANCES UNLESS OTHERWISE SPECIFIED (DIN7168)			0,5-3mm	3-6 mm	6-30mm	30-120mm	120-400mm	Dimension (mm)
			±0,1	±0,1	±0,2	±0,3	±0,5	m (medium)
			SCALE:1:1			SHEET 1 OF 2		

A3

HH-019 IF MACHINED TOGETHER

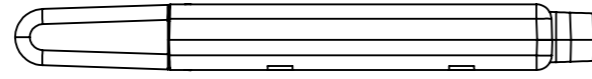

SURFACE-13

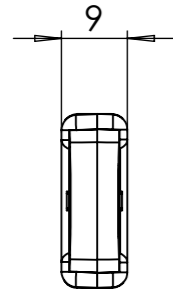
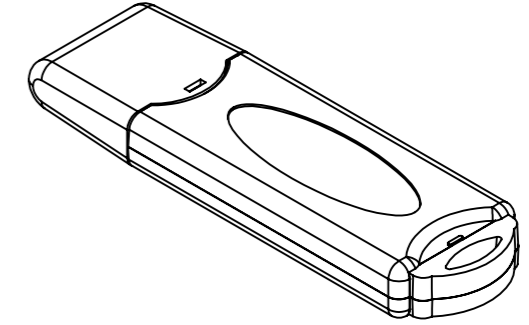

SURFACE-15

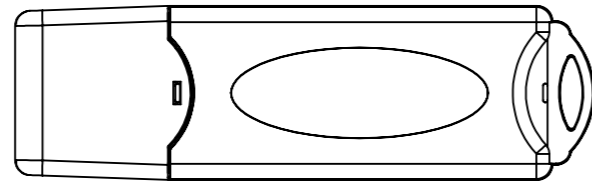

SURFACE-17

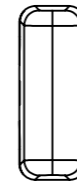

SURFACE-16

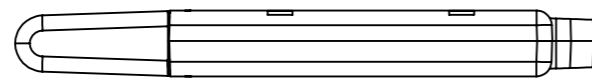

SURFACE-14

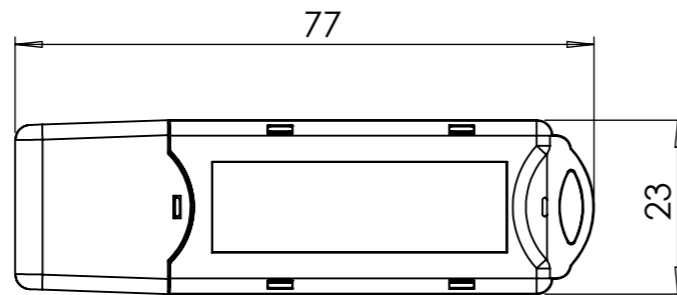
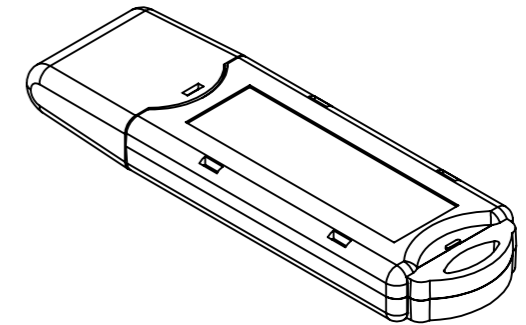

SURFACE-18

REV. NO	DATE	REVISED BY	DESCRIPTION OF CHANGE					
ALTINKAYA Electronic Enclosures & Components			www.altinkaya.com					
Customer Name:		Customer Ref:						
Altinkaya Ref :		Part Name : HH-019						
	NAME	DATE	Drawn From:					
DRAWN	S. YESILOZ	13.07.2024	Material :					
CHECKED	Y. YEL	13.07.2024	Weight:	UNIT : mm				
DIMENSIONAL TOLERANCES UNLESS OTHERWISE SPECIFIED (DIN7168)			0,5-3mm	3-6 mm	6-30mm	30-120mm	120-400mm	Dimension (mm)
			±0,1	±0,1	±0,2	±0,3	±0,5	m (medium)
SCALE:1:1 SHEET 2 OF 2								

A3