

**BASE: 6 SURFACE**

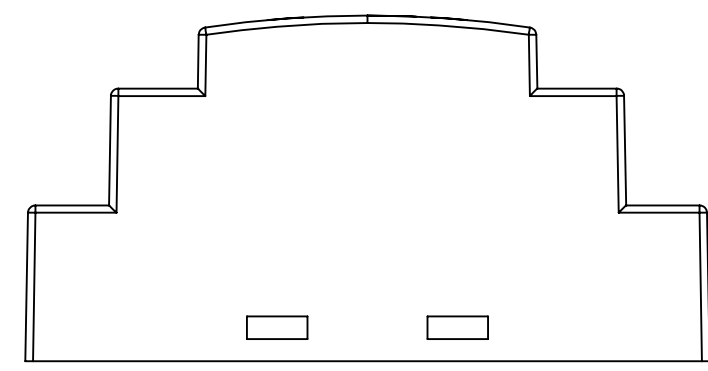

SURFACE-1

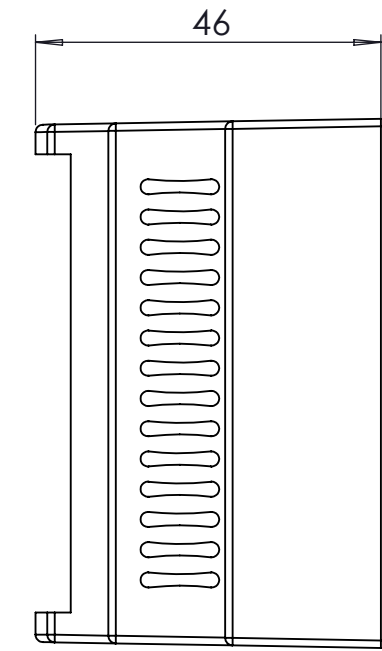

SURFACE-3

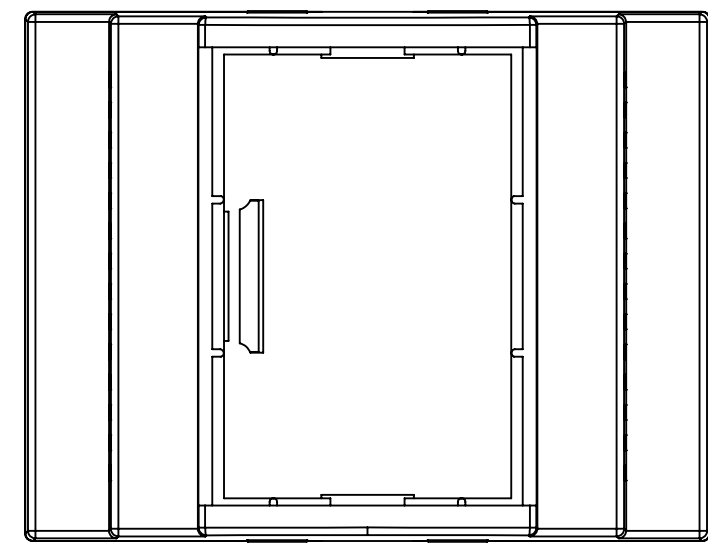

SURFACE-5

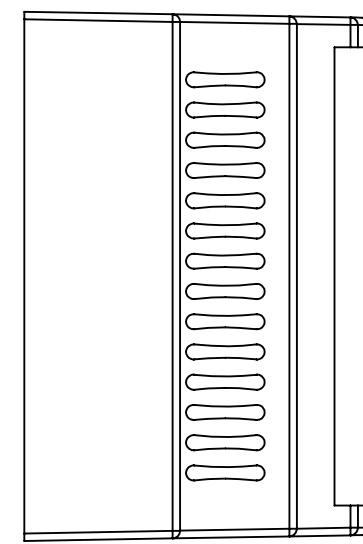

SURFACE-4

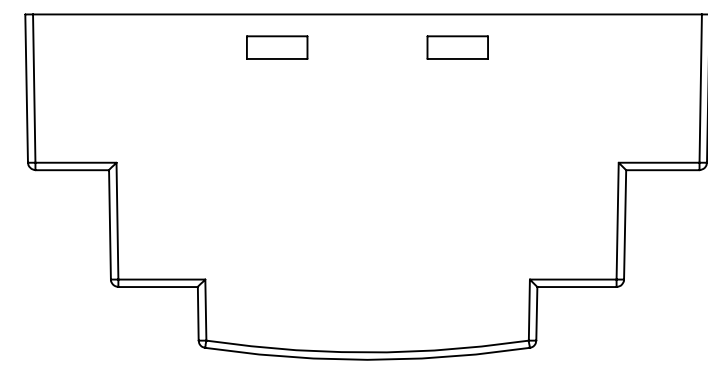

SURFACE-2

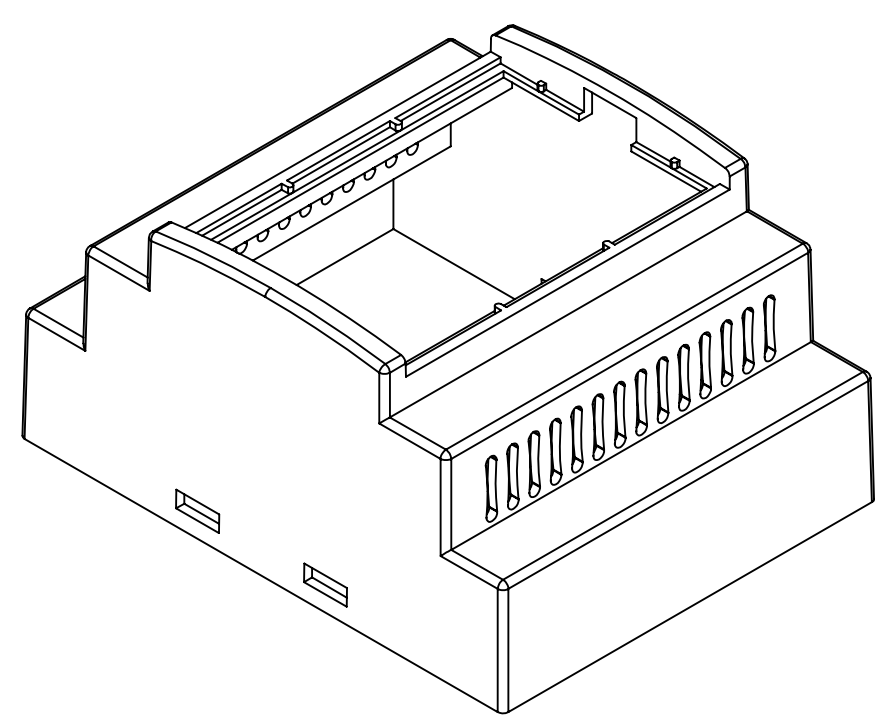

SURFACE-6 (INSIDE)

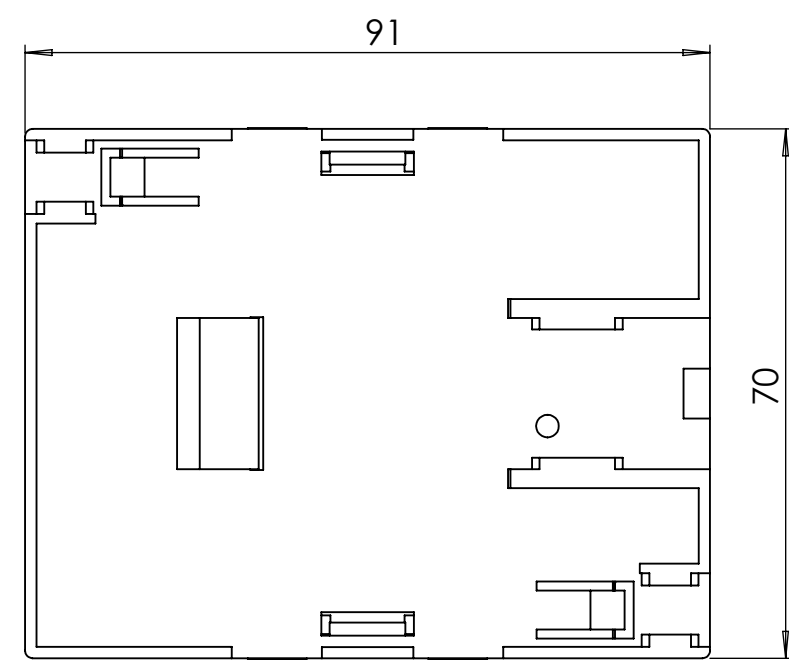

**COVER: 6 SURFACE**

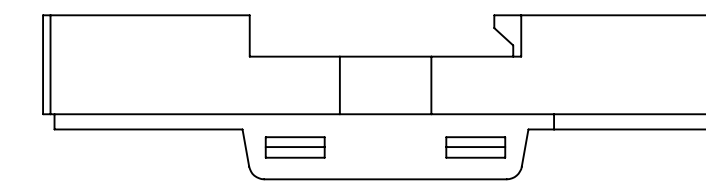

SURFACE-7

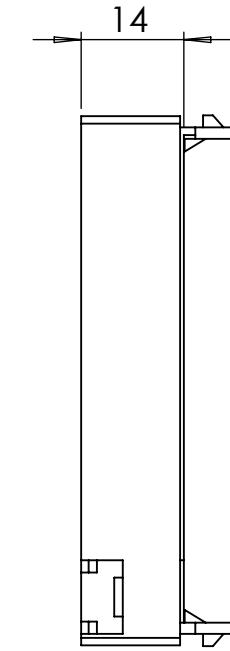

SURFACE-9

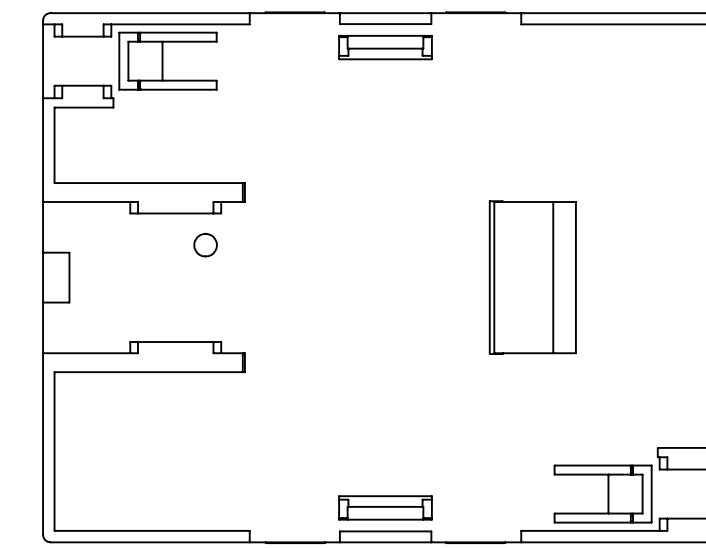

SURFACE-11

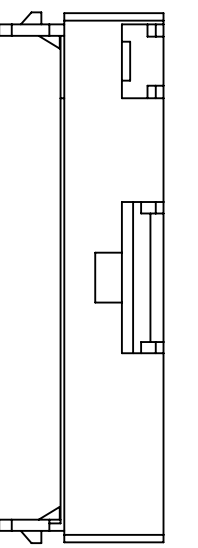

SURFACE-10

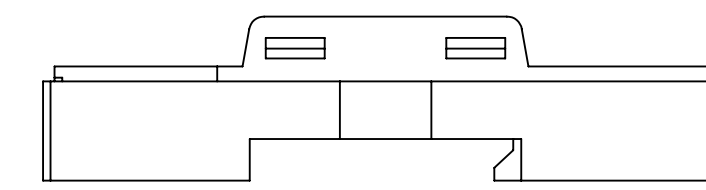

SURFACE-8

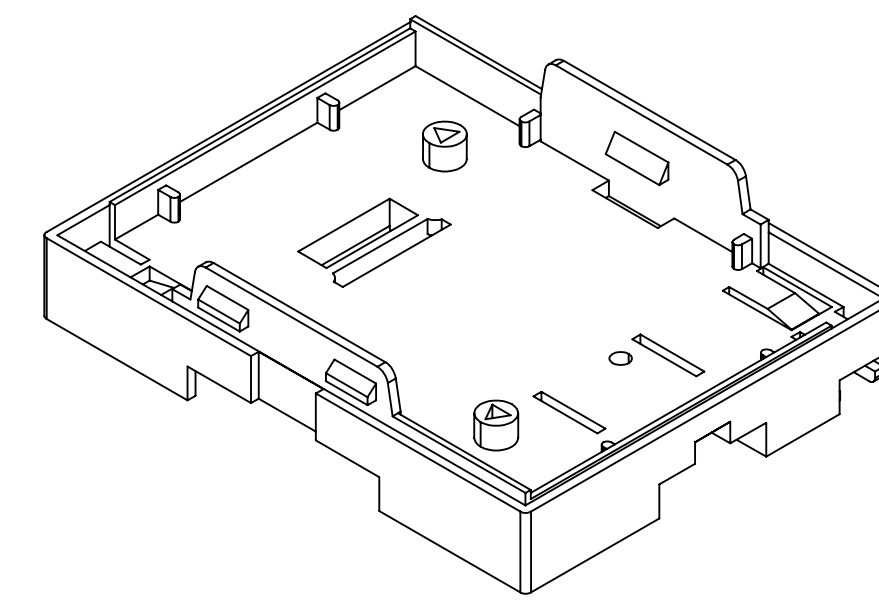

SURFACE-12 (INSIDE)

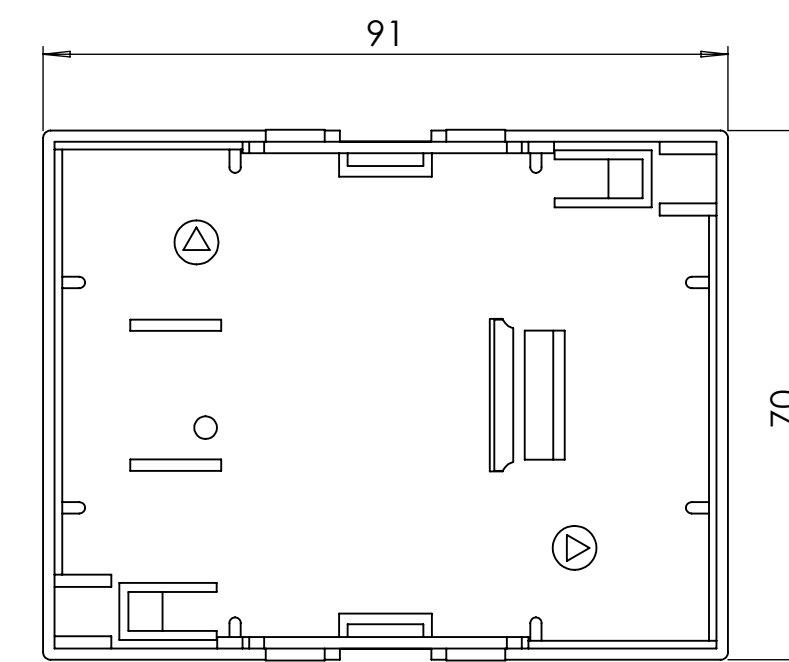

**PANEL: 2 SURFACE**

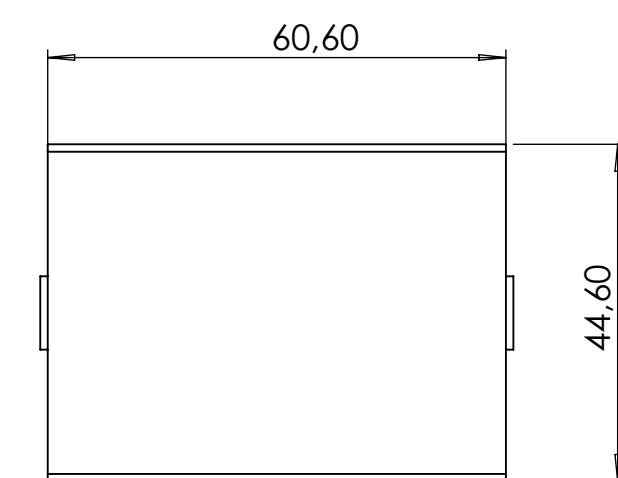
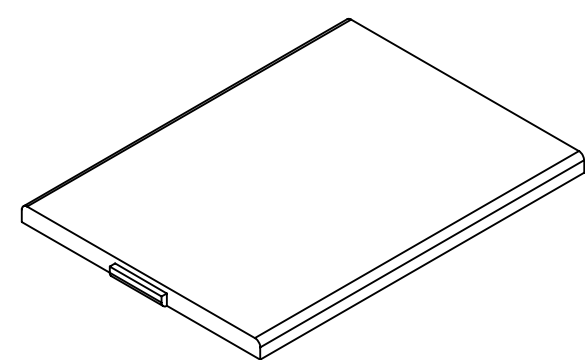

SURFACE-13

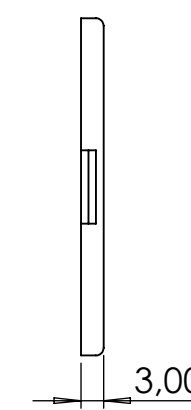

SURFACE-14 (INSIDE)

REV. NO.	DATE	REVISED BY	DESCRIPTION OF CHANGE
			www.altinkaya.com
Customer Name:		Customer Ref.:	
Altinkaya Ref.:		Part Name: RT-204-B	
DRAWN	NAME	DATE	Drawn From:
CHECKED	Y. YESLOZ	27.07.2024	Material:
DIMENSIONAL TOLERANCES UNLESS OTHERWISE SPECIFIED:			SCALE 1:1 UNIT : mm
[R&T148]	±0.1	±0.1	±0.2 ±0.3 ±0.5

# RT-204-B IF MACHINED TOGETHER

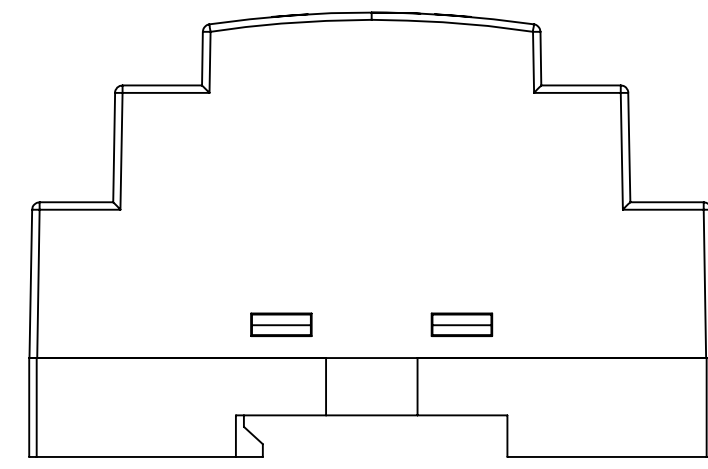

SURFACE-15

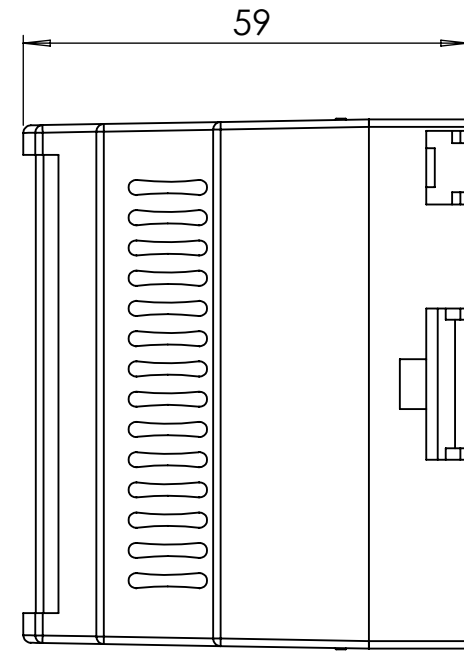

SURFACE-17

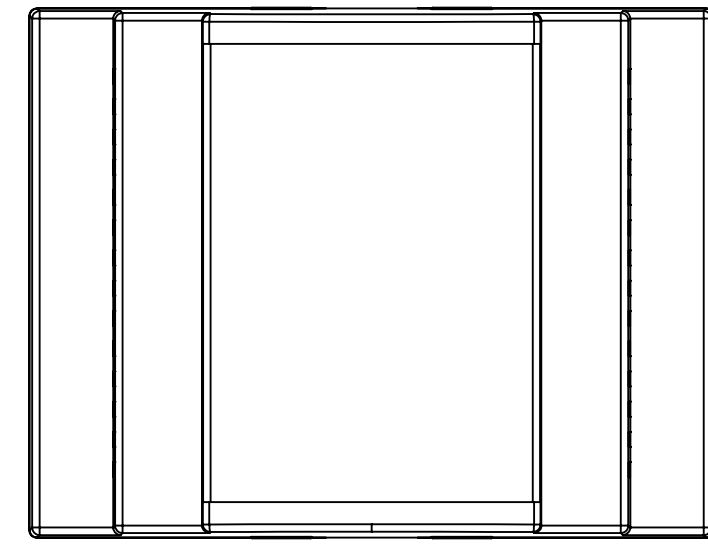

SURFACE-19

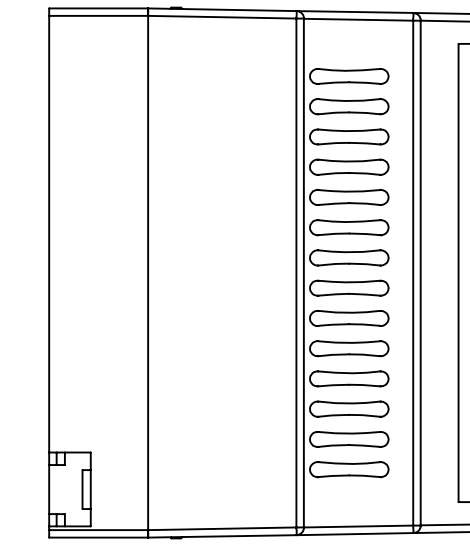

SURFACE-18

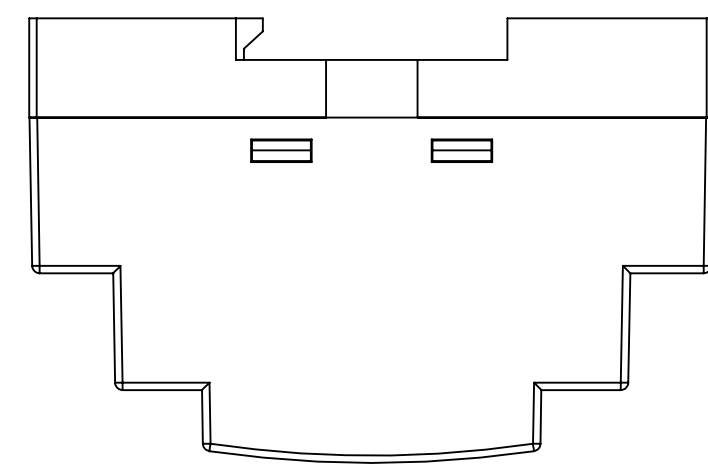
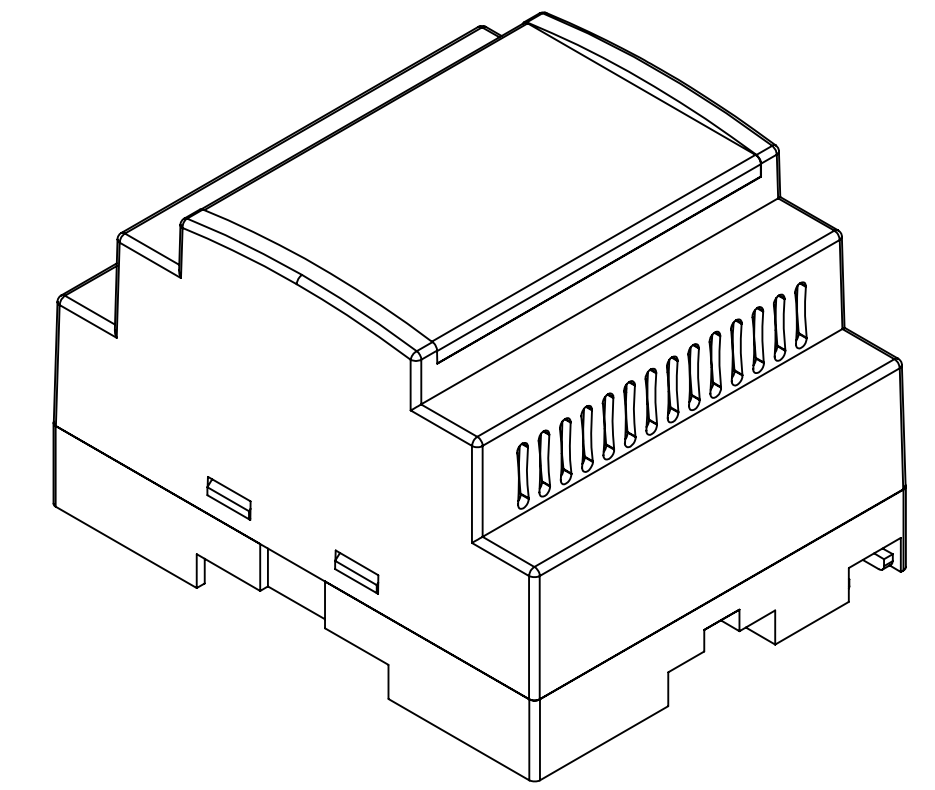

SURFACE-16

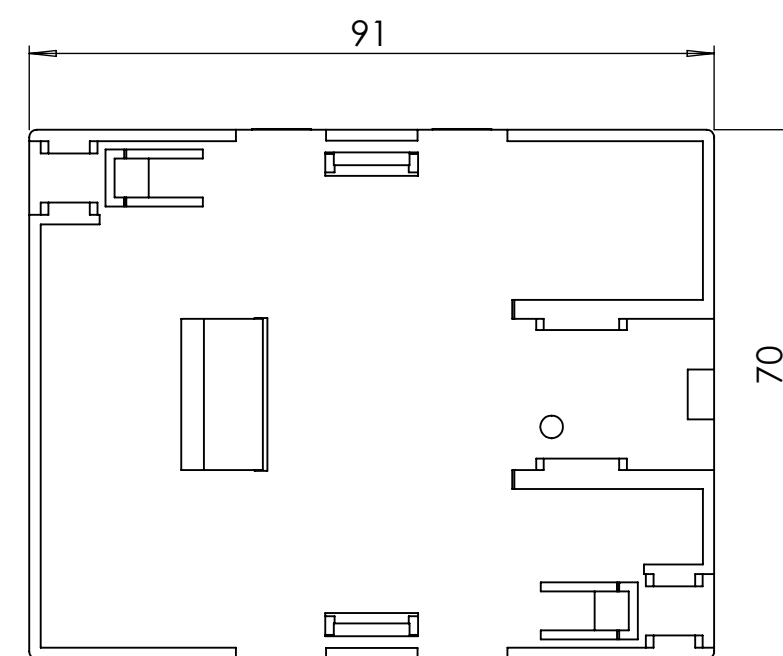

SURFACE-20

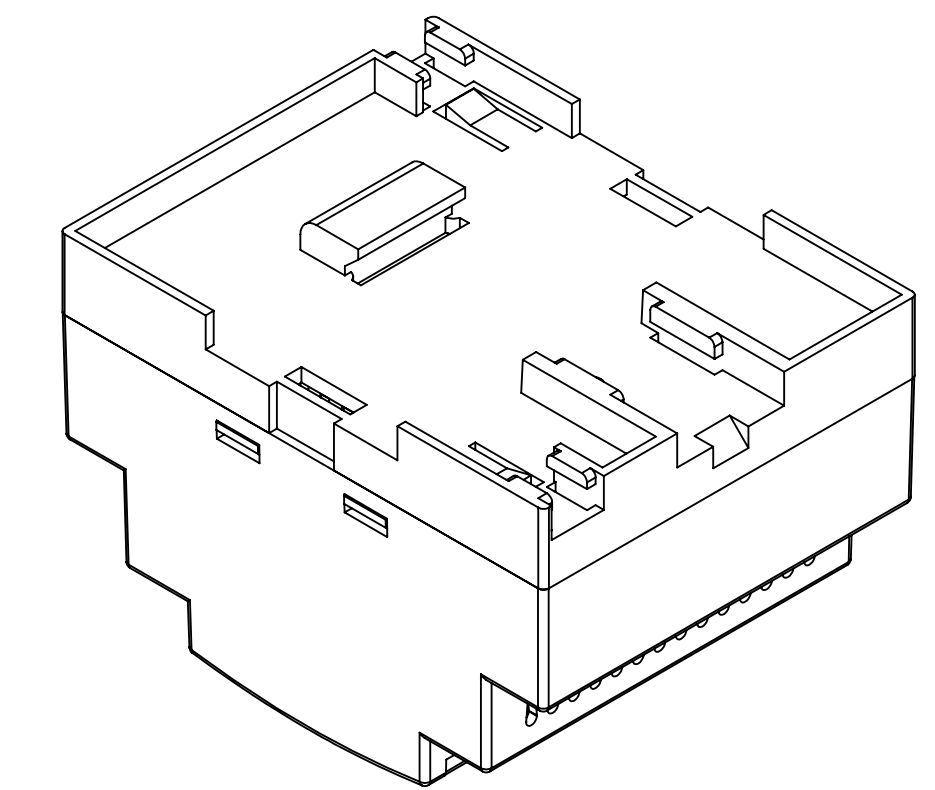

REV. NO.	DATE	REVISED BY	DESCRIPTION OF CHANGE
<span style="float: right;"><b>www.altinkaya.com</b></span>			
Customer Name:		Customer Ref.:	
Altinkaya Ref.:		Part Name: RT-204-B	
DRAWN	NAME	DATE	Drawn From:
CHECKED	Y. YESILOZ	27.07.2024	Material:
DIMENSIONAL TOLERANCES UNLESS OTHERWISE SPECIFIED:		Weight:	SCALE 1:1 UNIT : mm
(DIN7148)	±0.1	±0.1	±0.2
	±0.3	±0.5	Dimension(mm)
			m(medium)
			1
			SHEET 2 OF 2