

# BASE: 6 SURFACE

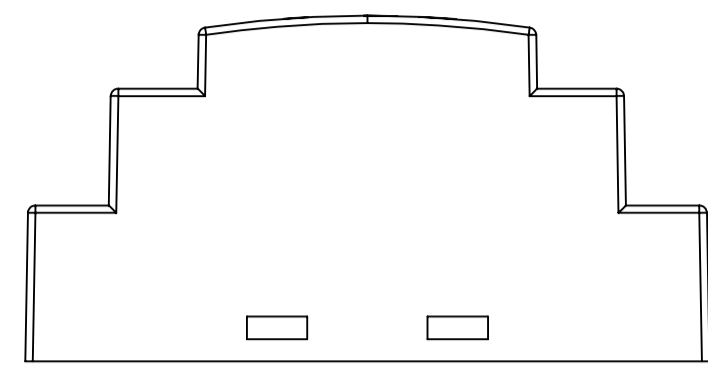

SURFACE-1

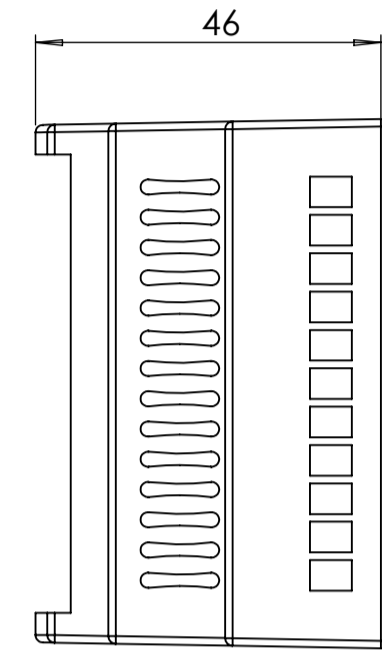

SURFACE-3

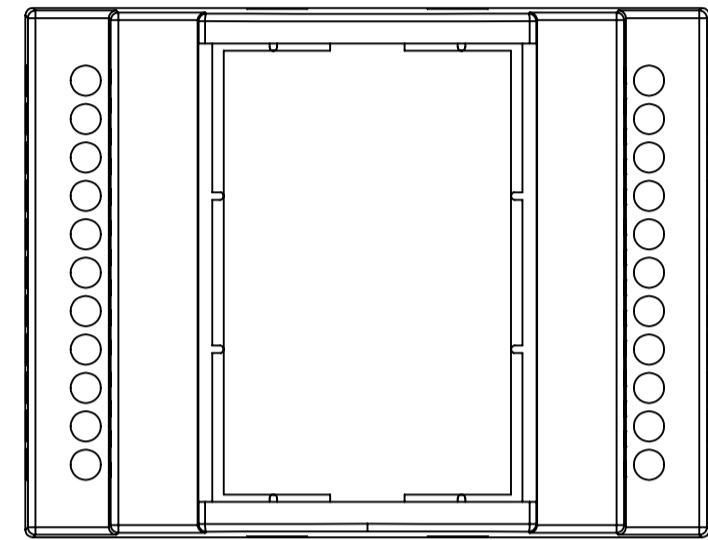

SURFACE-5

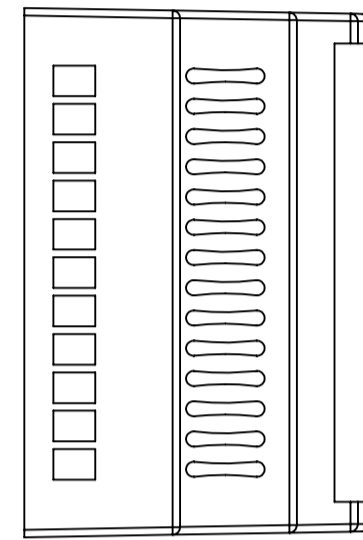

SURFACE-4

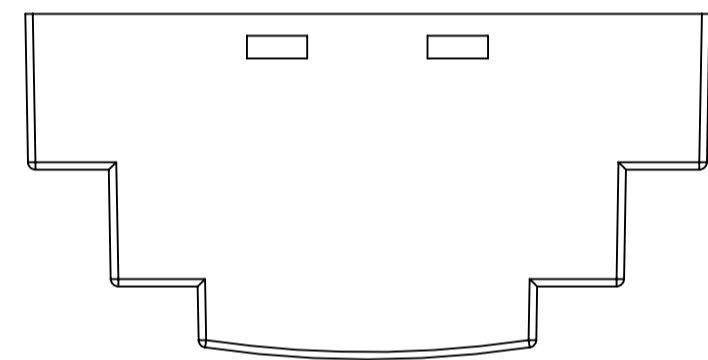

SURFACE-2

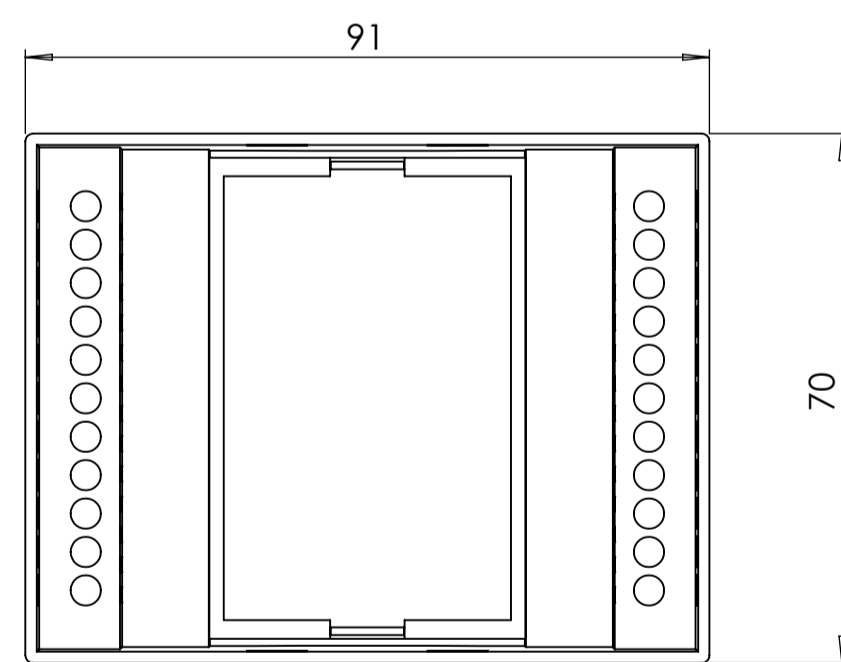
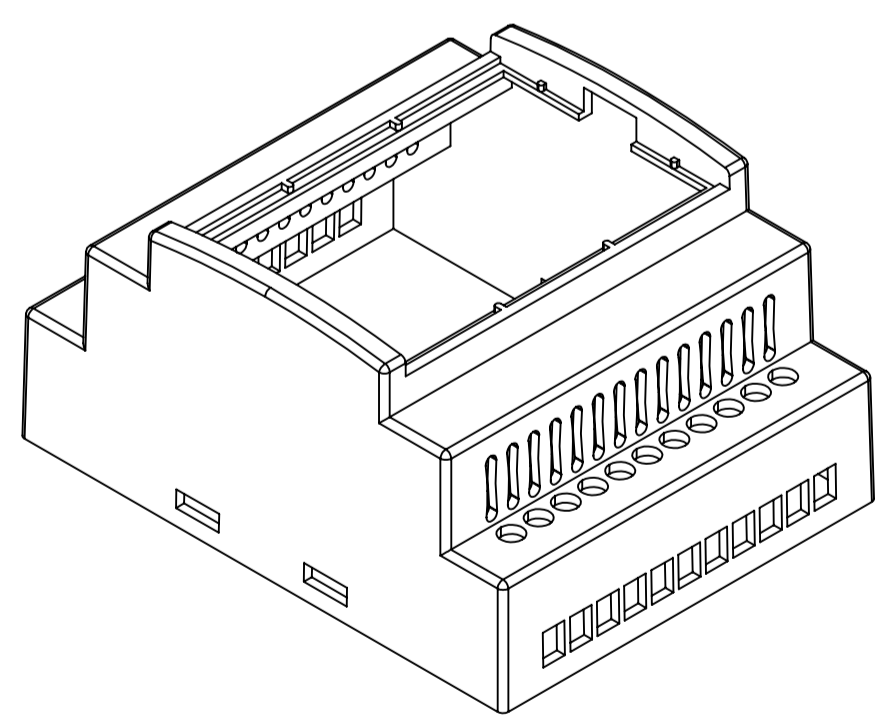

SURFACE-6 (INSIDE)

# COVER: 6 SURFACE

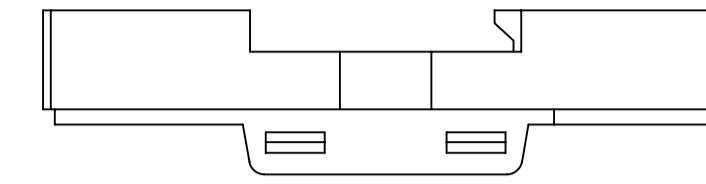

SURFACE-7

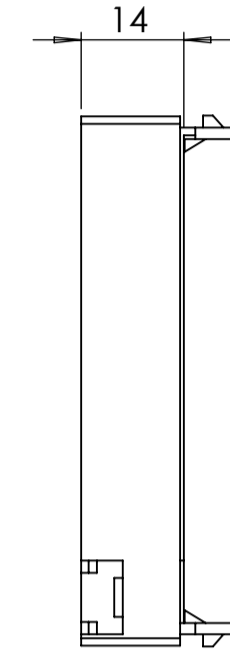

SURFACE-9

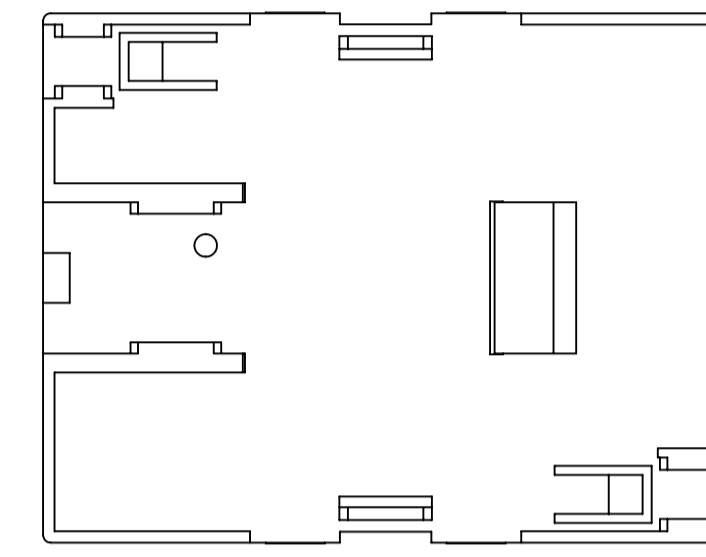

SURFACE-11

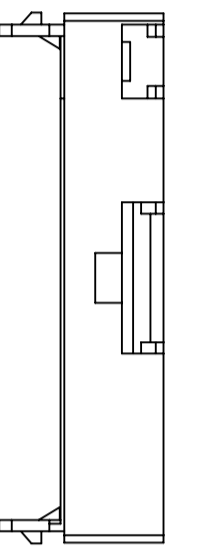

SURFACE-10

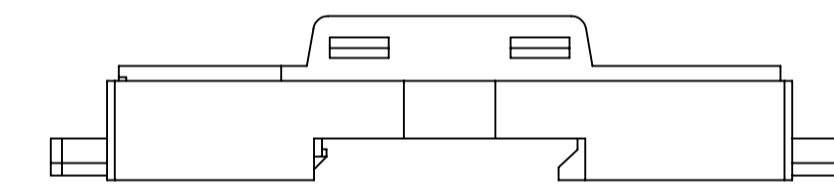

SURFACE-8

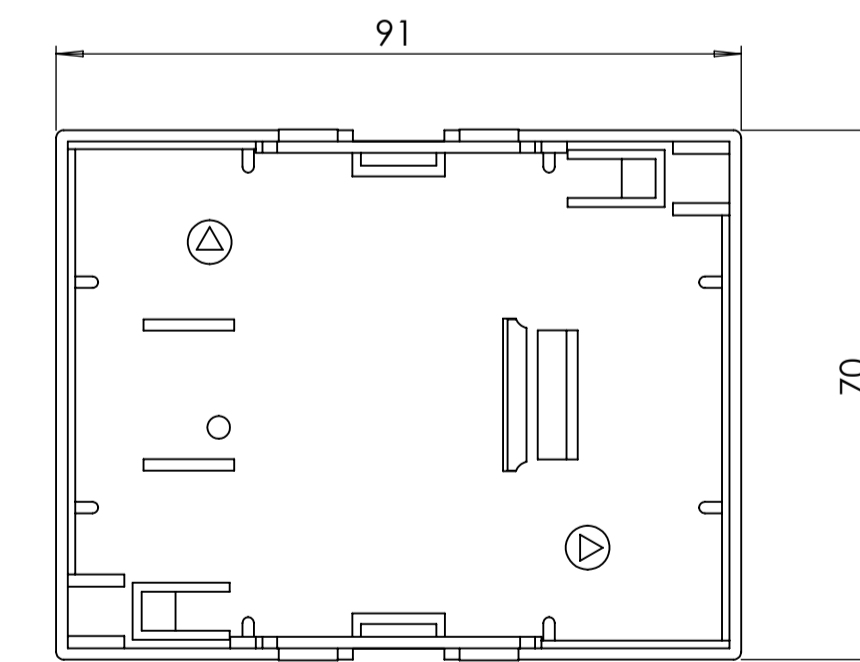
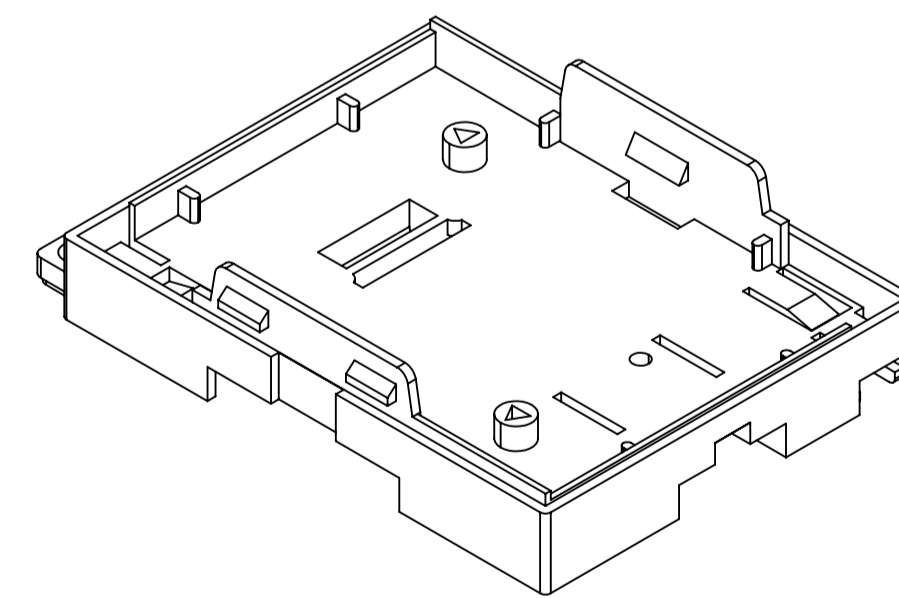

SURFACE-12 (INSIDE)

# PANEL: 2 SURFACE

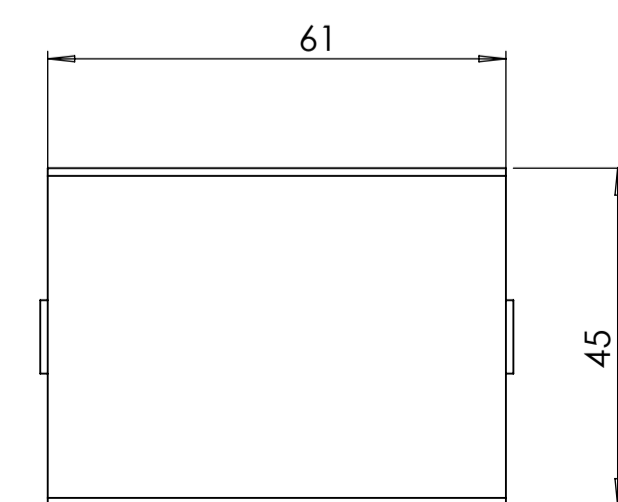
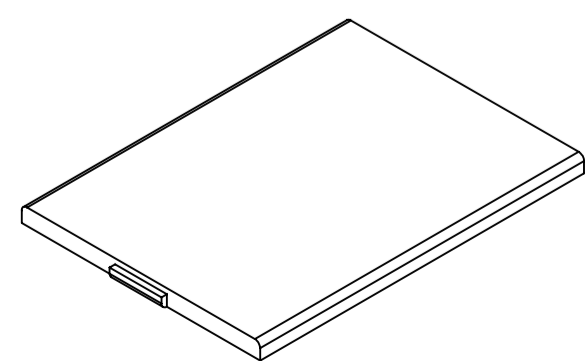

SURFACE-13

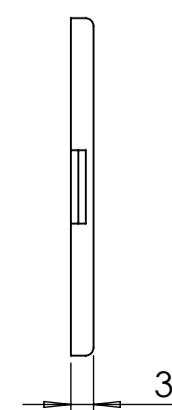

SURFACE-14 (INSIDE)

REV. NO.	DATE	REVISED BY	DESCRIPTION OF CHANGE
 <b>ALTINKAYA</b> Electronic Enclosures & Components <a href="http://www.altinkaya.com">www.altinkaya.com</a>			
Customer Name:		Customer Ref.:	
Altinkaya Ref.:		Part Name: RT-204-C	
DRAWN	NAME	DATE	Drawn From:
CHECKED	Y. YESLOZ	27.07.2024	Material:
DIMENSIONAL TOLERANCES UNLESS OTHERWISE SPECIFIED:		Weight:	SCALE 1:1 UNIT : mm
[R47.148]	±0.1	±0.1	±0.2
	±0.3	±0.5	Dimension(mm)
			120-400mm
			m(medium)
			A1
			SHEET 1 OF 2

# RT-204-C IF MACHINED TOGETHER

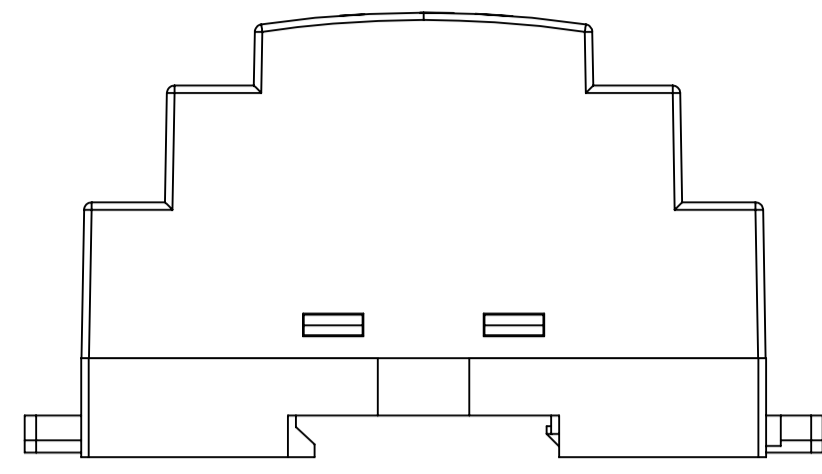

SURFACE-15

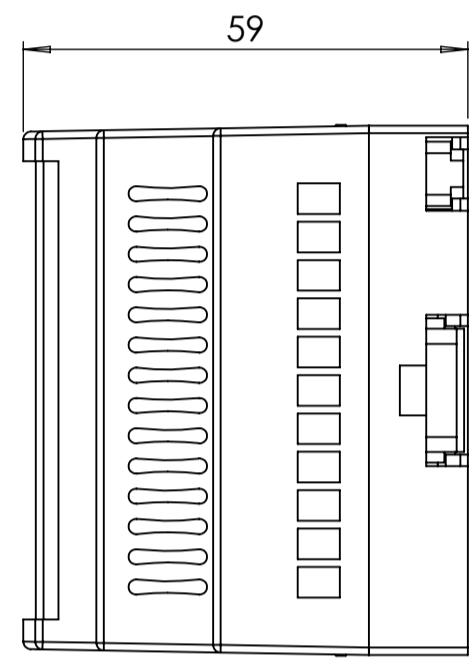

SURFACE-17

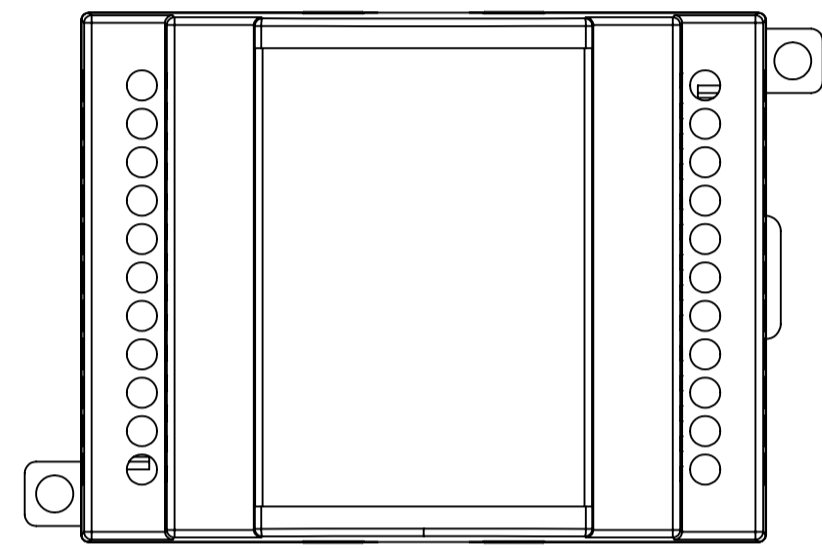

SURFACE-19

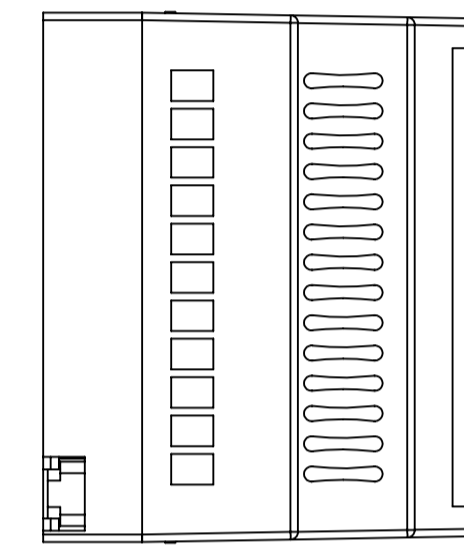

SURFACE-18

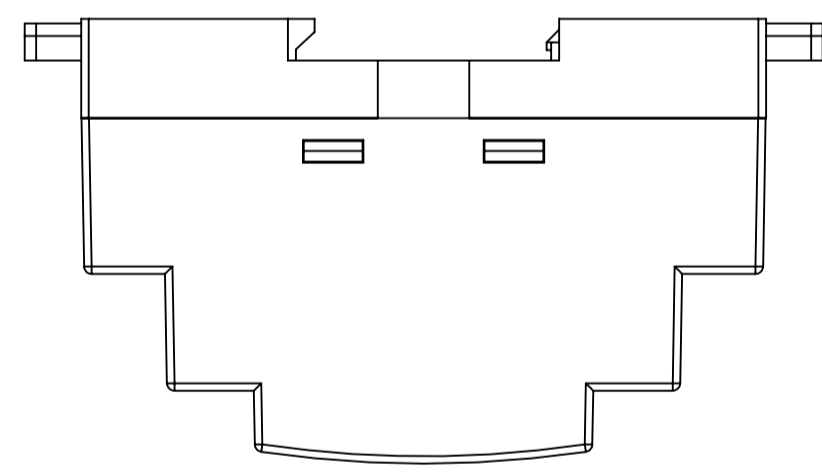
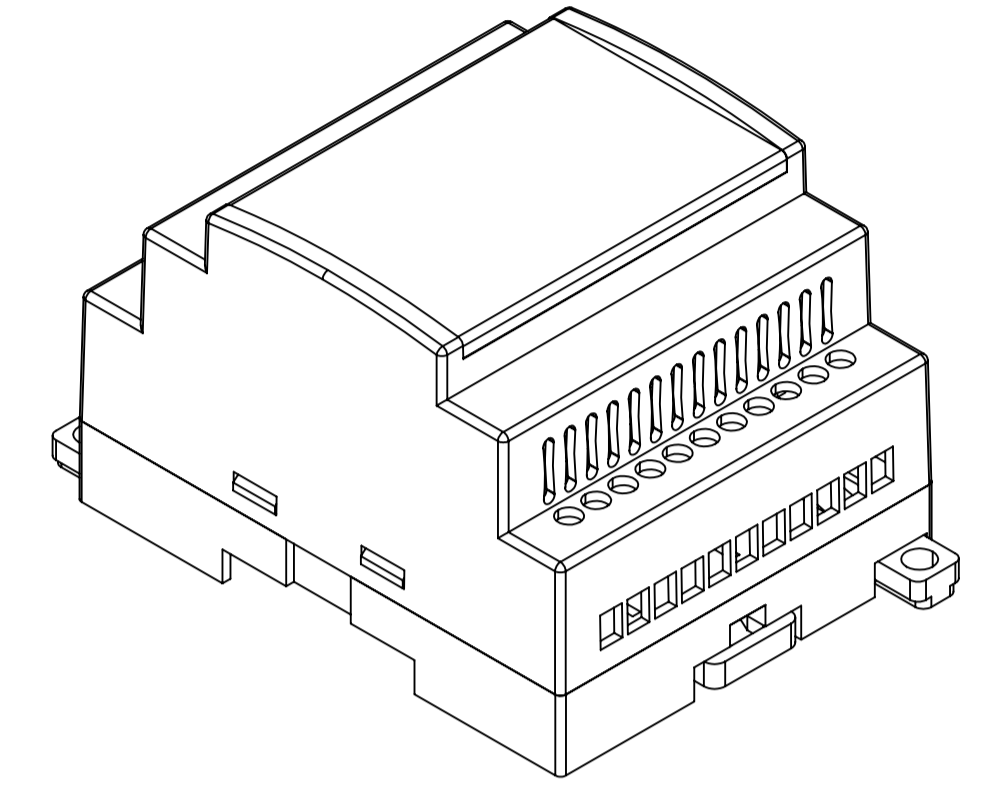

SURFACE-16

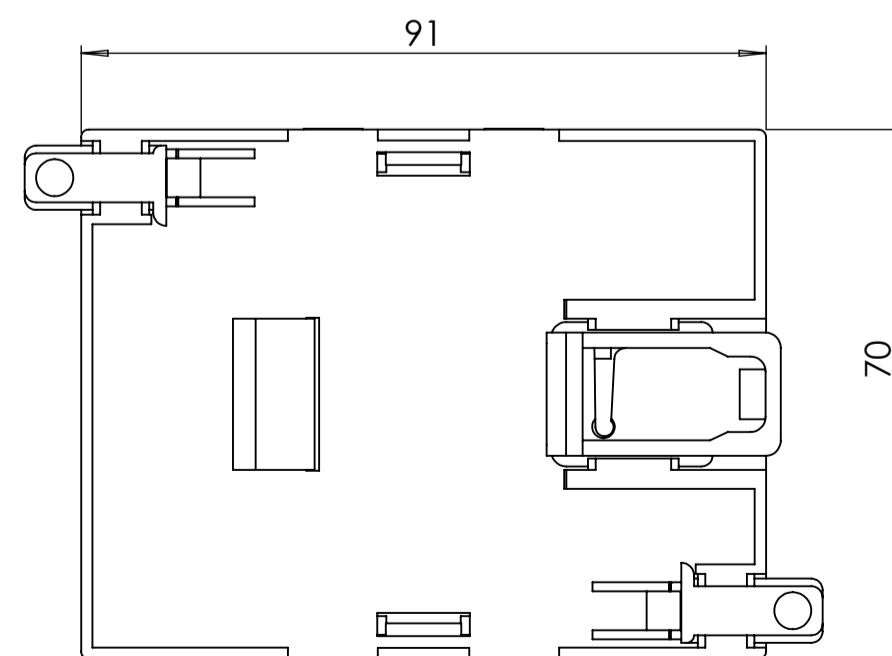

SURFACE-20

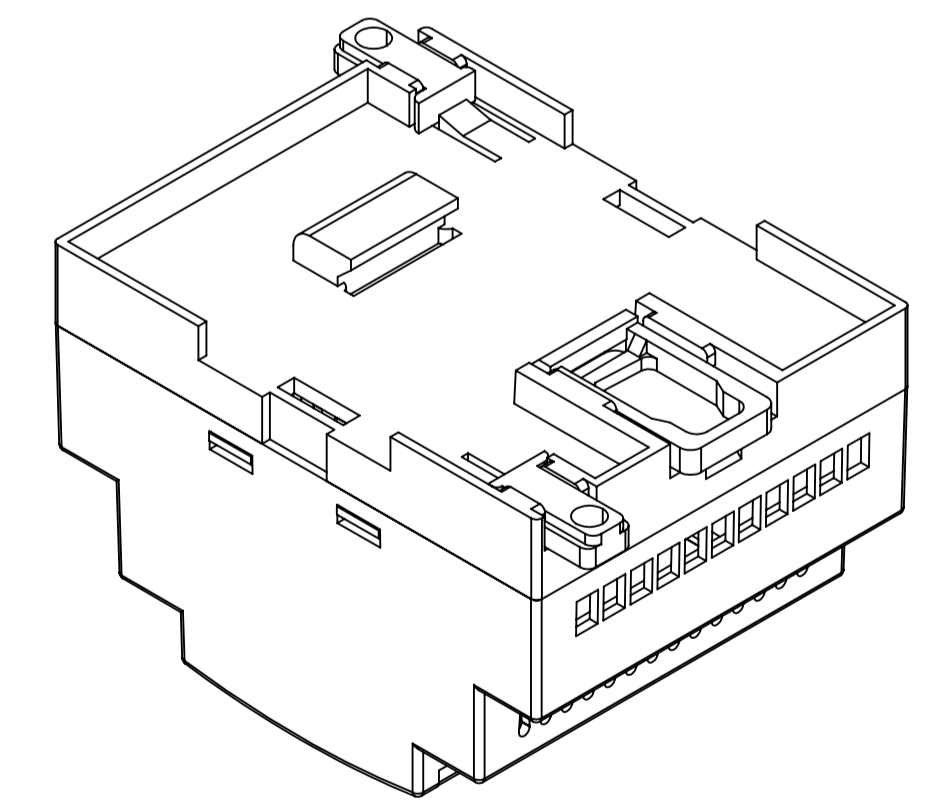

REV. NO.	DATE	REVISED BY	DESCRIPTION OF CHANGE
<b>ALTINKAYA</b> Electronic Enclosures & Components			
Customer Name:		Customer Ref.:	
Altinkaya Ref.:		Part Name: RT-204-C	
DRAWN	NAME	DATE	Drawn From:
CHECKED	Y. YESILOZ	27.07.2024	Material:
DIMENSIONAL TOLERANCES UNLESS OTHERWISE SPECIFIED:		Weight:	SCALE 1:1 UNIT : mm
(R&T) 148	±0.1	±0.1	±0.2
	±0.3	±0.5	
			Dimension(mm) m(medium)