

**BASE: 6 SURFACE**

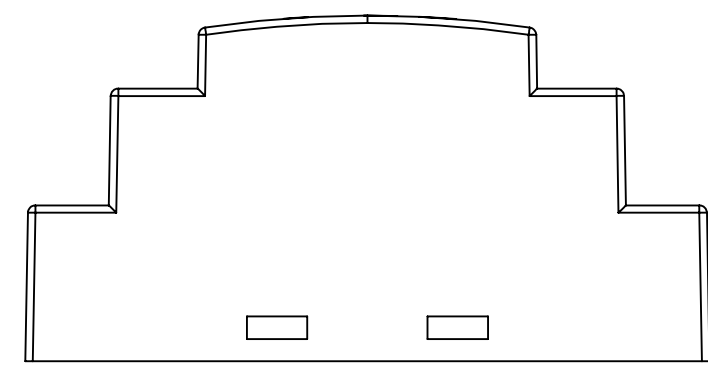

SURFACE-1

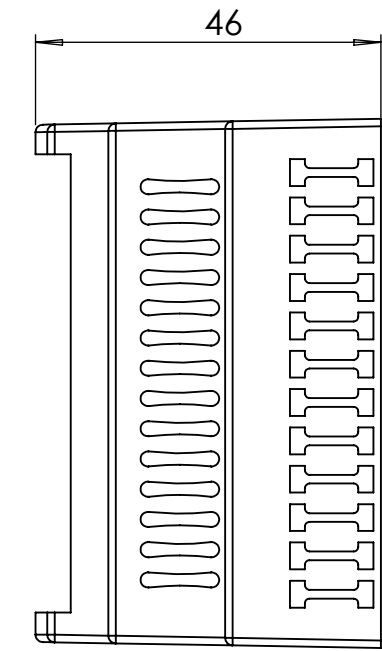

SURFACE-3

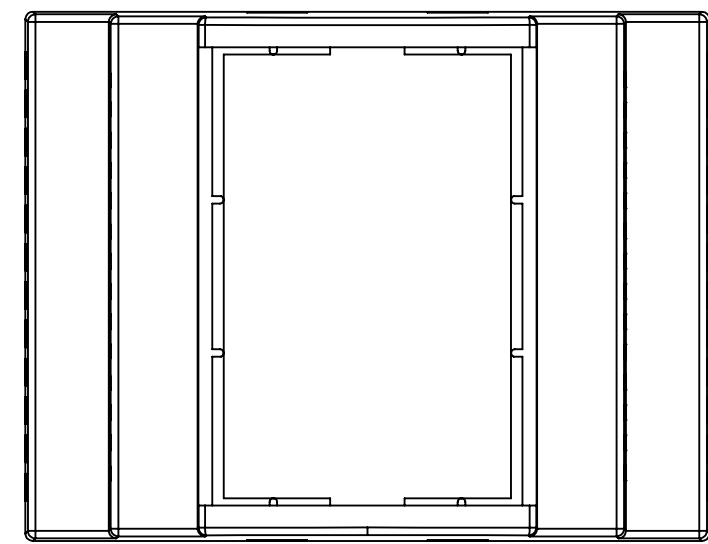

SURFACE-5

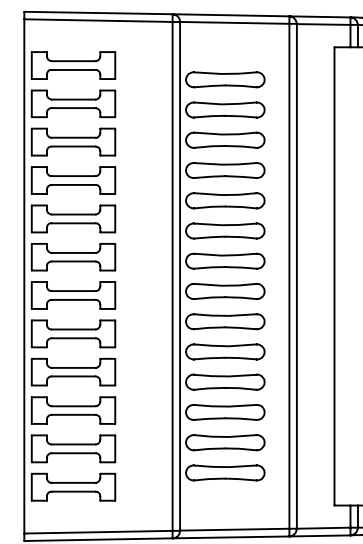

SURFACE-4

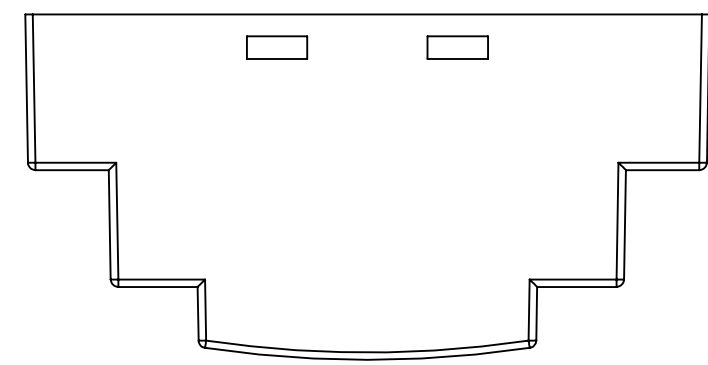

SURFACE-2

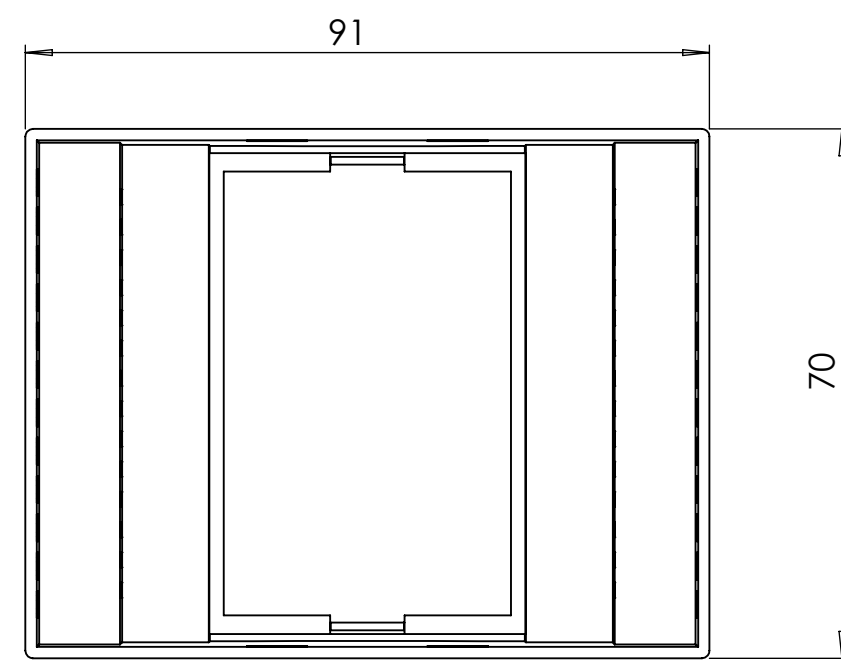
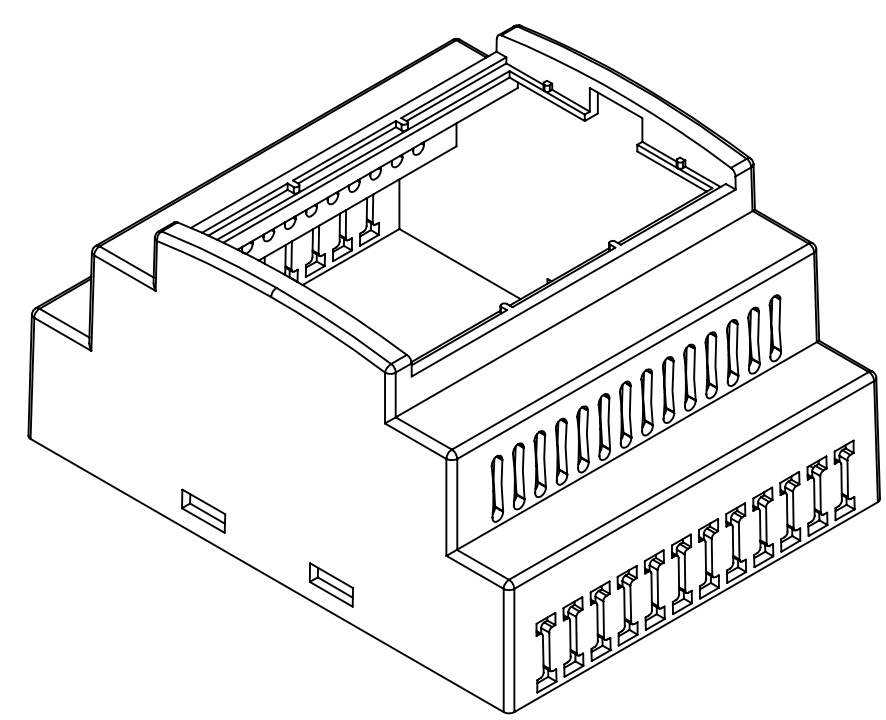

SURFACE-6 (INSIDE)

**COVER: 6 SURFACE**

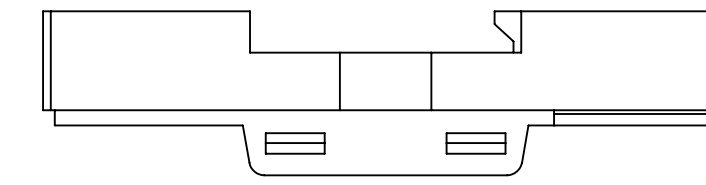

SURFACE-7

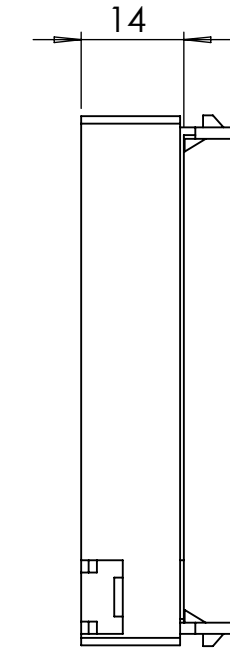

SURFACE-9

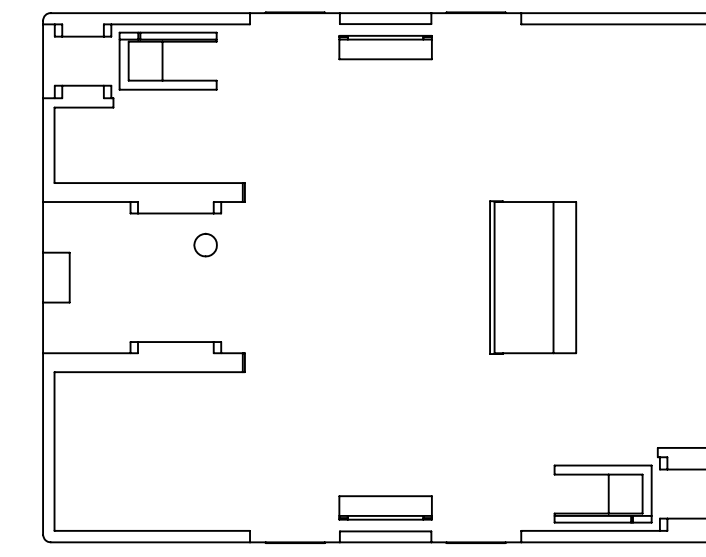

SURFACE-11

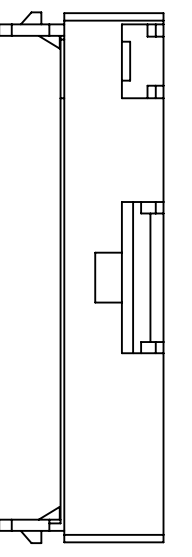

SURFACE-10

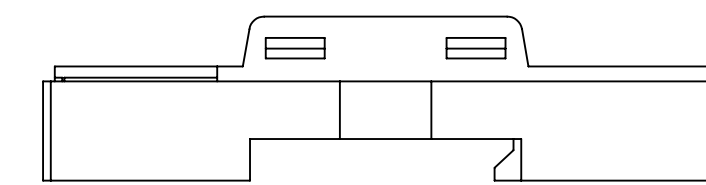

SURFACE-8

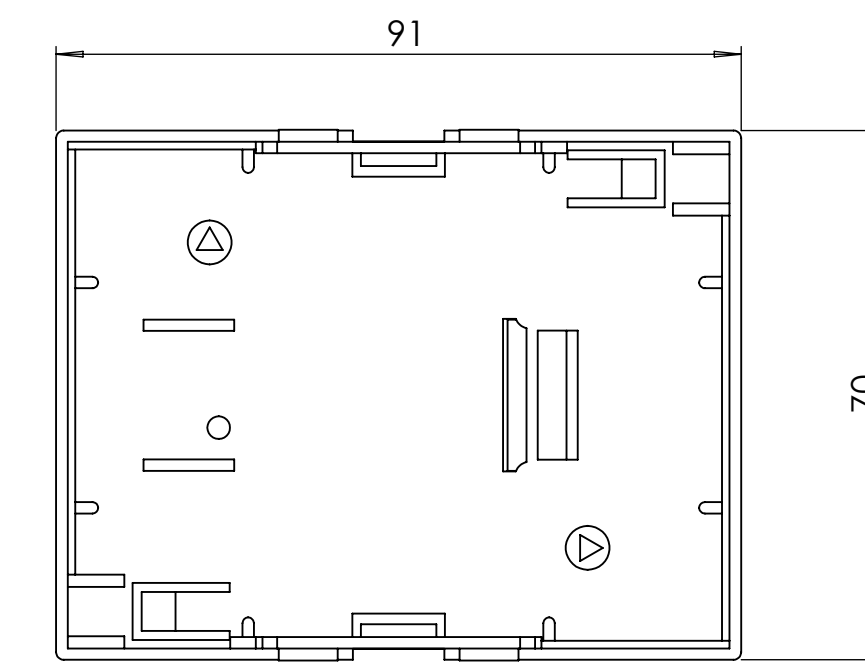
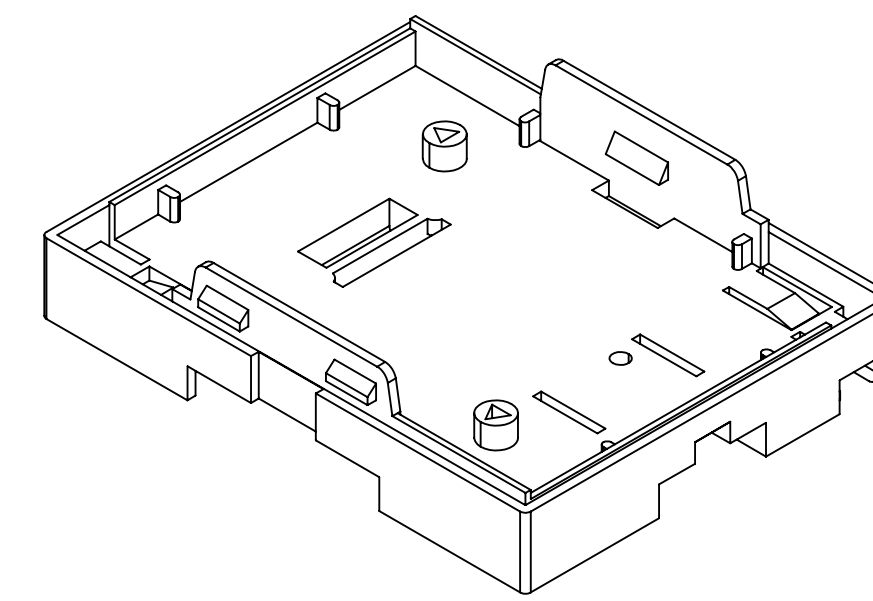

SURFACE-12 (INSIDE)

**PANEL: 2 SURFACE**

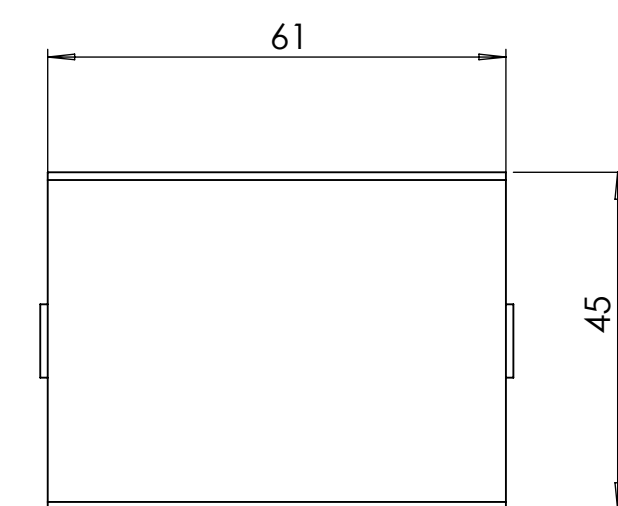
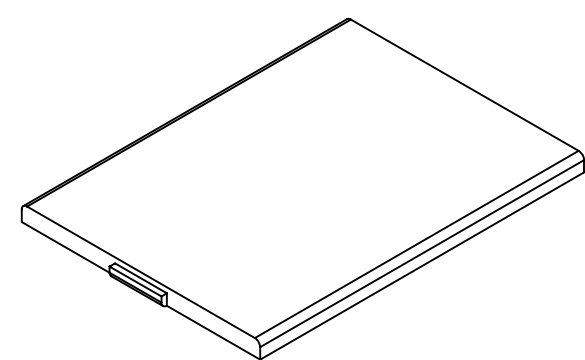

SURFACE-13

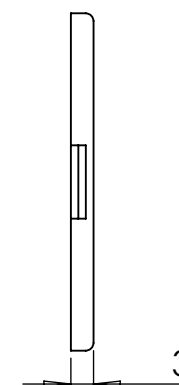

SURFACE-14 (INSIDE)

REV. NO.	DATE	REVISED BY	DESCRIPTION OF CHANGE
 <b>ALTINKAYA</b> Electronic Enclosures & Components <a href="http://www.altinkaya.com">www.altinkaya.com</a>			
Customer Name:		Customer Ref.:	
Altinkaya Ref.:		Part Name: RT-204-D	
DRAWN	NAME	DATE	Drawn From:
CHECKED	Y. YEL	27.07.2024	Material:
DIMENSIONAL TOLERANCES UNLESS OTHERWISE SPECIFIED:		Weight:	SCALE 1:1 UNIT : mm
[RNF7148]	±0.1	±0.1	±0.2
	±0.3	±0.5	Dimension(mm)
			m(medium)
			A1
			SHEET 1 OF 2

# RT-204-D IF MACHINED TOGETHER

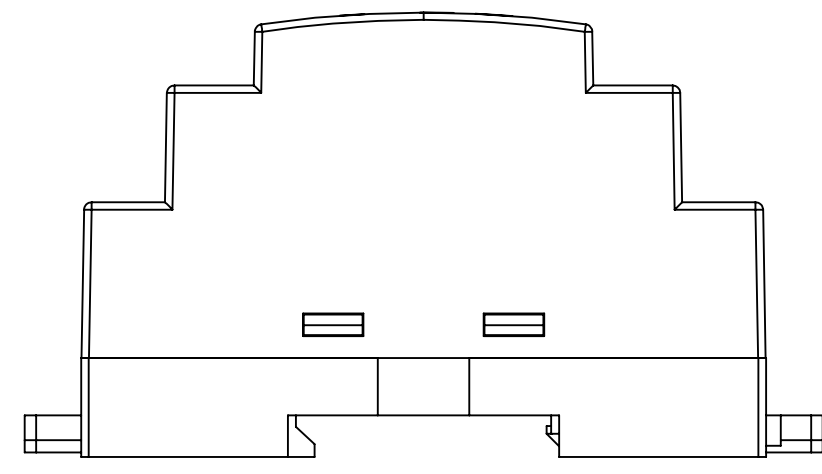

SURFACE-15

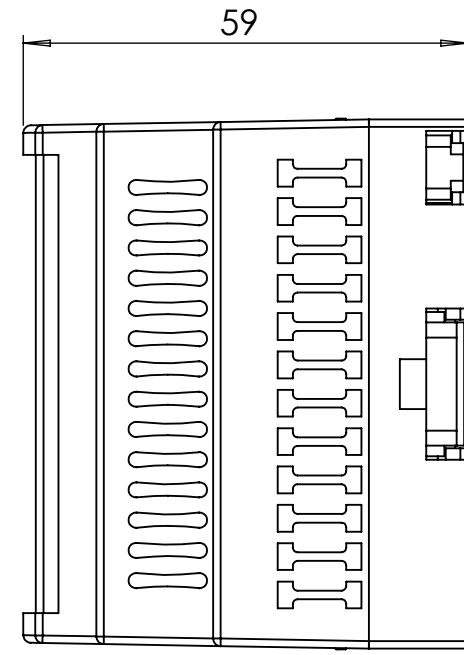

SURFACE-17

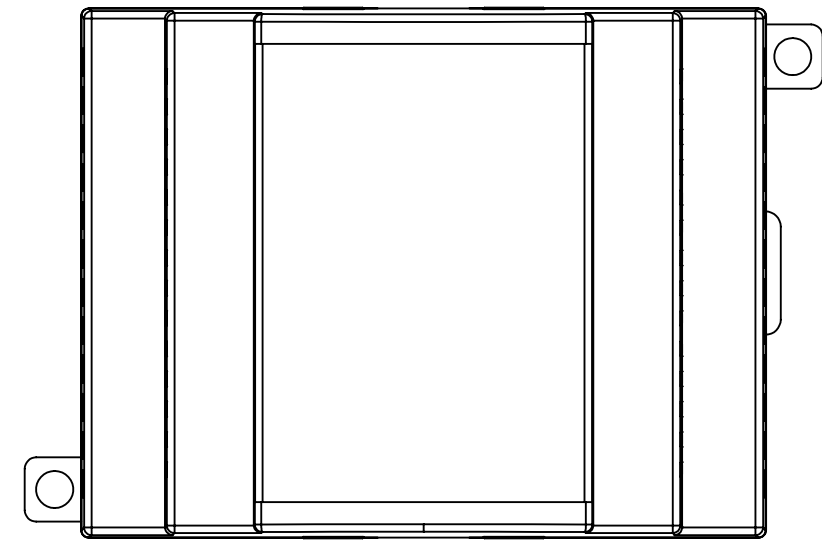

SURFACE-19

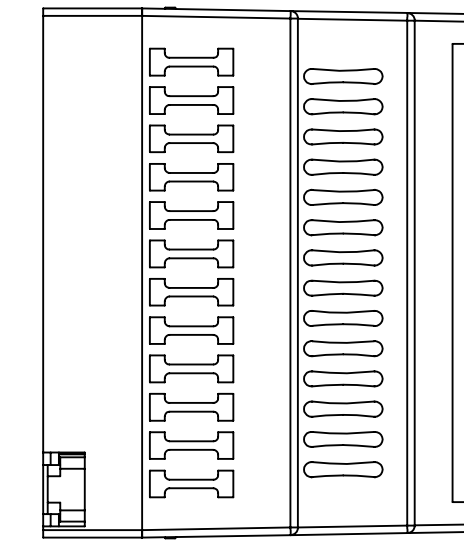

SURFACE-18

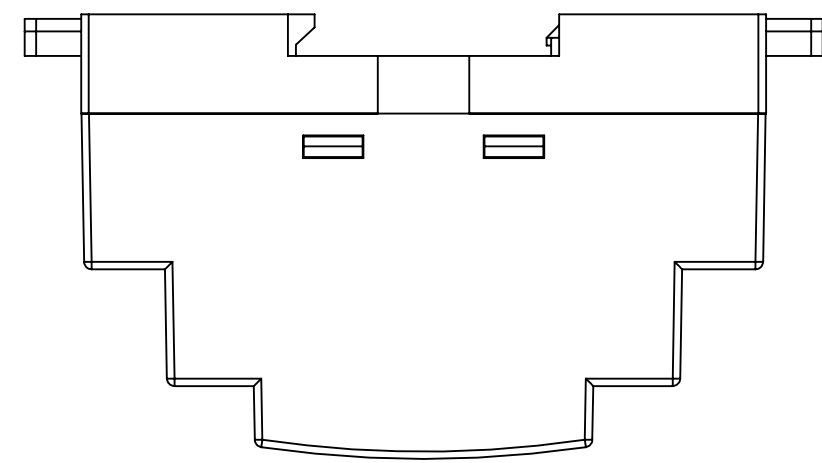
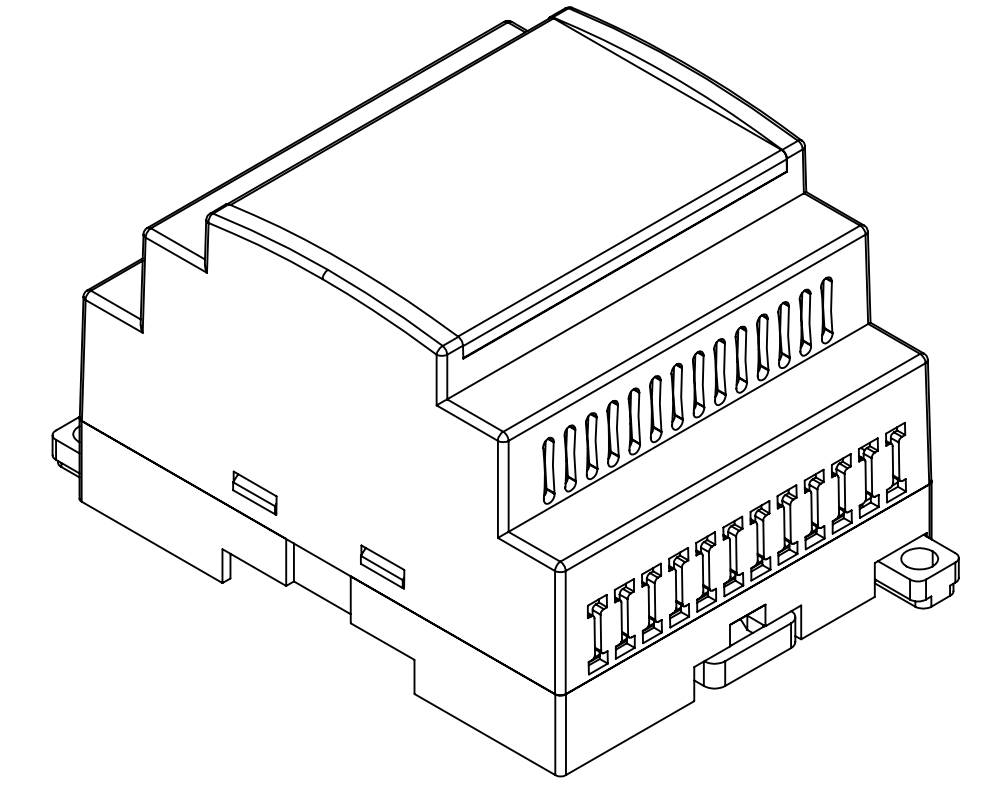

SURFACE-16

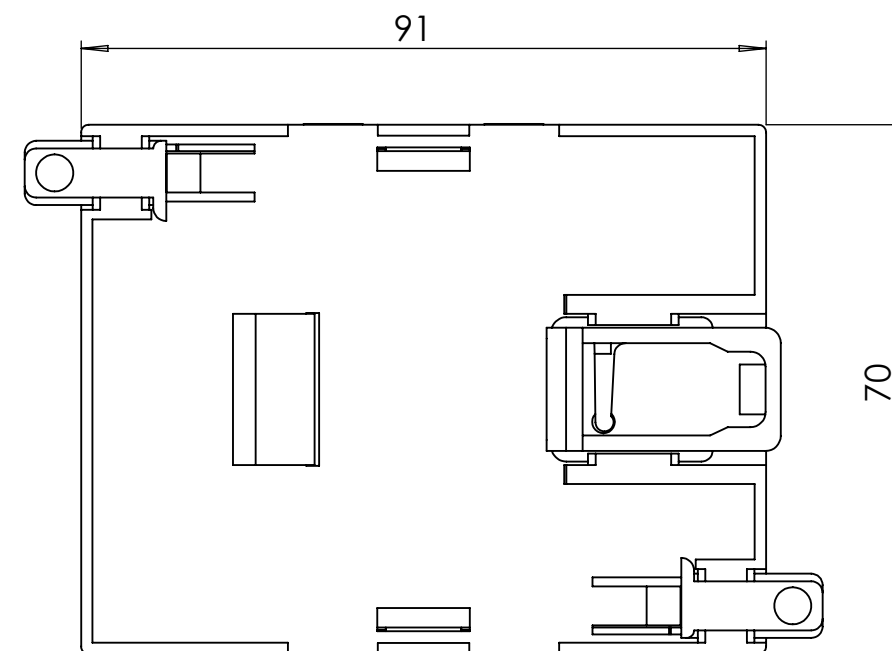

SURFACE-20

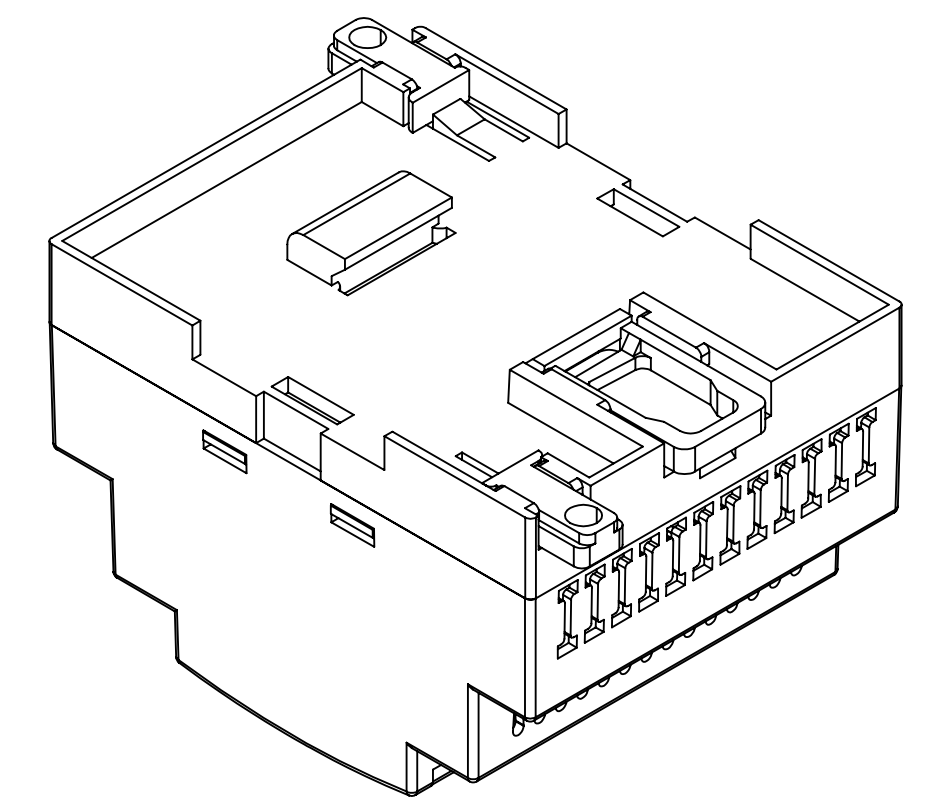

REV. NO.	DATE	REVISED BY	DESCRIPTION OF CHANGE
<span style="float: right;"><a href="http://www.altinkaya.com">www.altinkaya.com</a></span>			
Customer Name:		Customer Ref.:	
Altinkaya Ref.:		Part Name: RT-204-D	
DRAWN	NAME	DATE	Drawn From:
CHECKED	Y. YESILOZ	27.07.2024	Material:
DIMENSIONAL TOLERANCES UNLESS OTHERWISE SPECIFIED:			Weight:
(mm)	±0.1	±0.1	±0.2
		±0.3	±0.5
SCALE 1:1			UNIT : mm
Dimension(mm)			A1
m(medium)			SHEET 2 OF 2