

**BASE: 6 SURFACE**

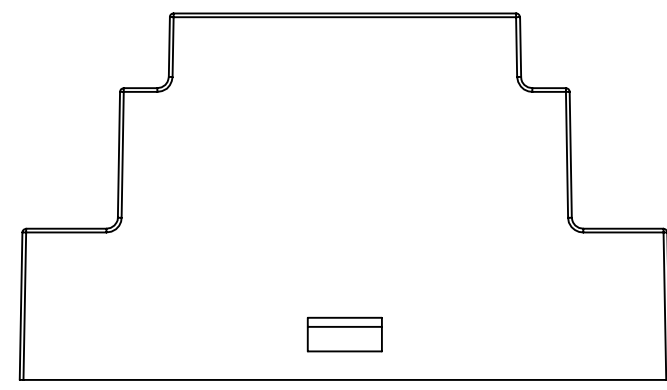

SURFACE-1

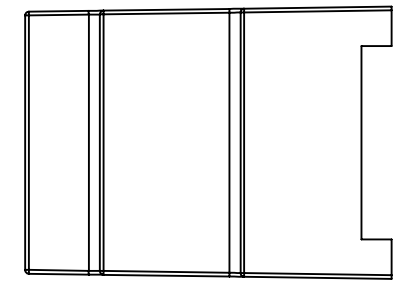

SURFACE-3

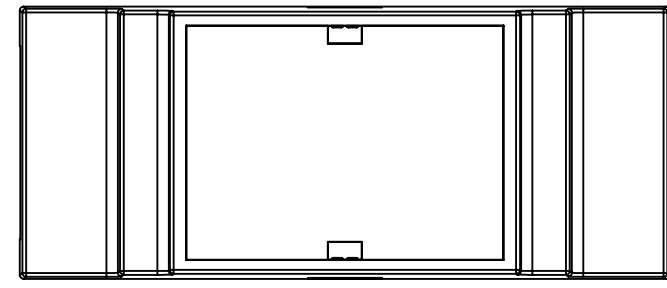

SURFACE-5

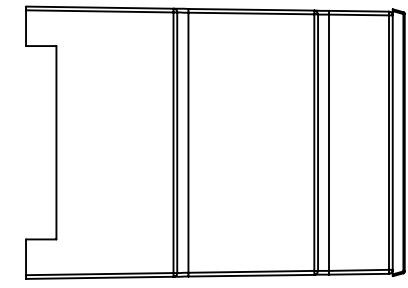

SURFACE-4

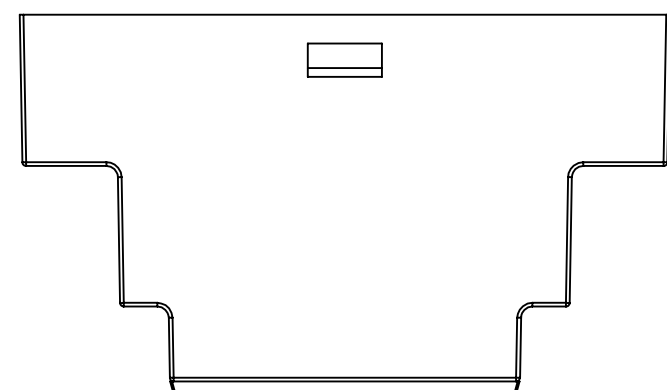
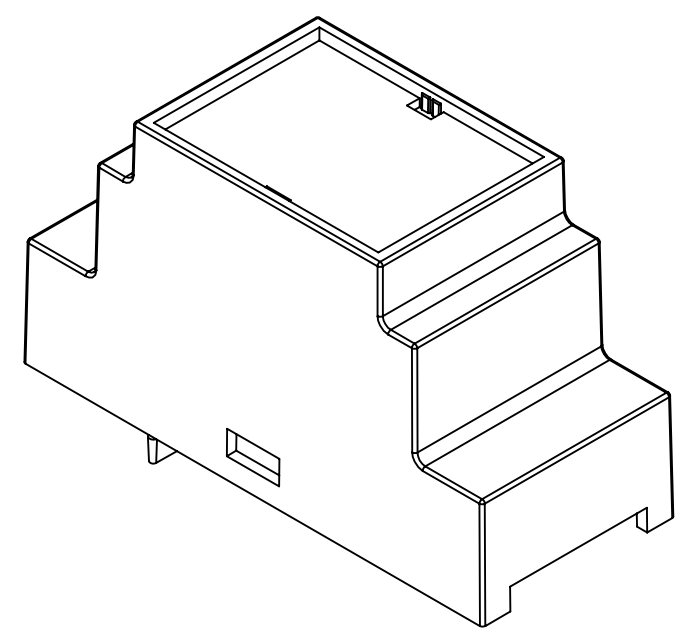

SURFACE-2

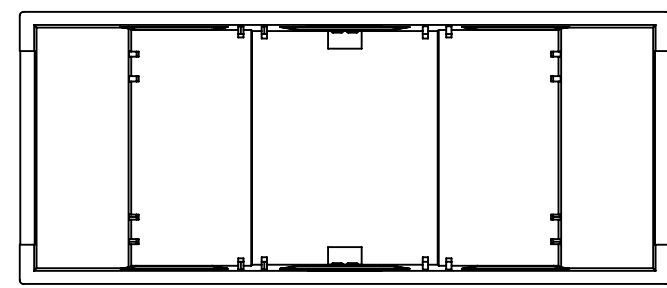

SURFACE-6 (INSIDE)

**COVER: 6 SURFACE**

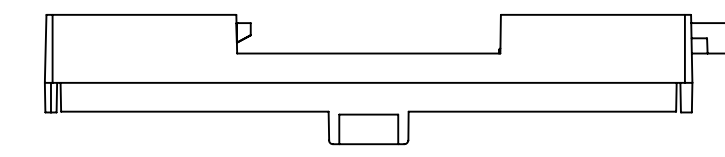

SURFACE-7

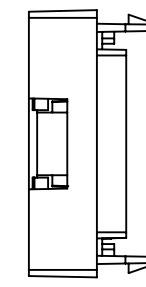

SURFACE-9

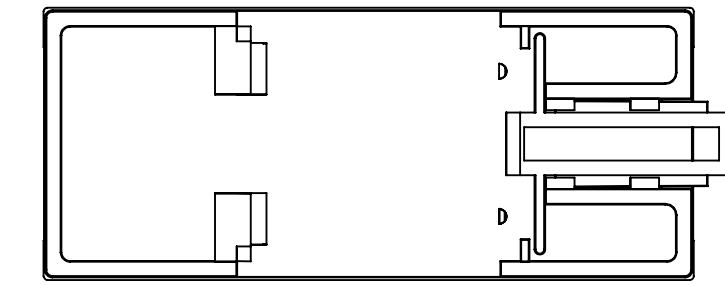

SURFACE-11

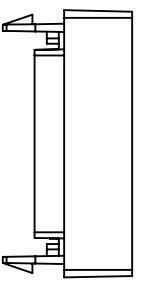

SURFACE-10

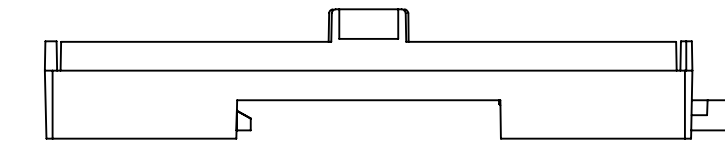
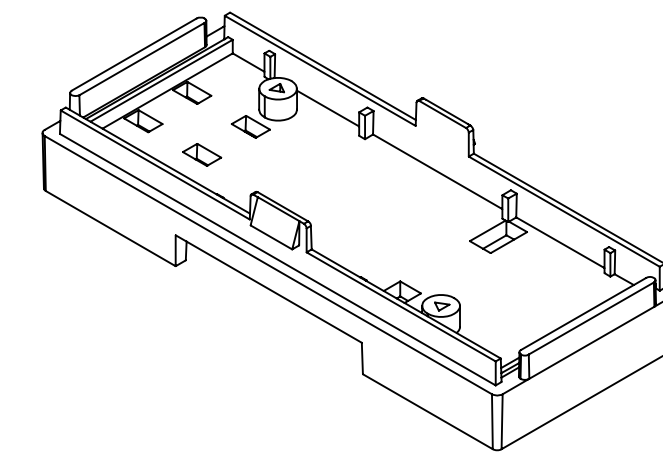

SURFACE-8

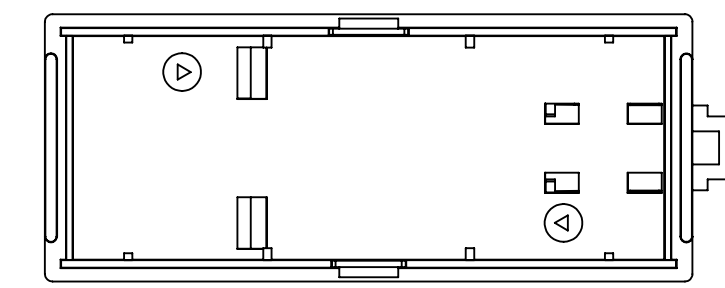

SURFACE-12 (INSIDE)

**PANEL: 2 SURFACE**

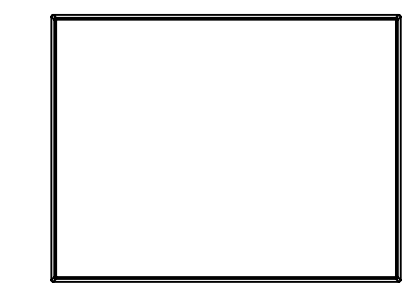
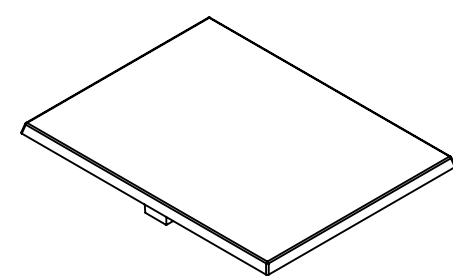

SURFACE-13

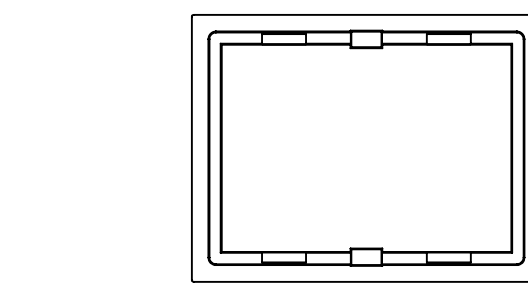
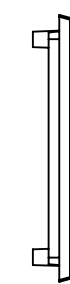

SURFACE-14 (INSIDE)

REV. NO.	DATE	REVISED BY	DESCRIPTION OF CHANGE
			www.altinkaya.com
Customer Name:		Customer Ref.:	
Altinkaya Ref.:		Part Name: RT-102-A	
DRAWN	NAME	DATE	Drawn From:
CHECKED	Y.YEL	24.07.2024	Material:
DIMENSIONAL TOLERANCES UNLESS OTHERWISE SPECIFIED:			SCALE 1:1   UNIT : mm
[R47148]	±0.1	±0.1	±0.2 ±0.3 ±0.5
	0.5-3mm	3-6mm	6-30mm 30-120mm 120-400mm
			Dimension(mm)
			m(medium)
			A1
			SHEET 1 OF 2

**RT-102 MACHINED TOGETHER**

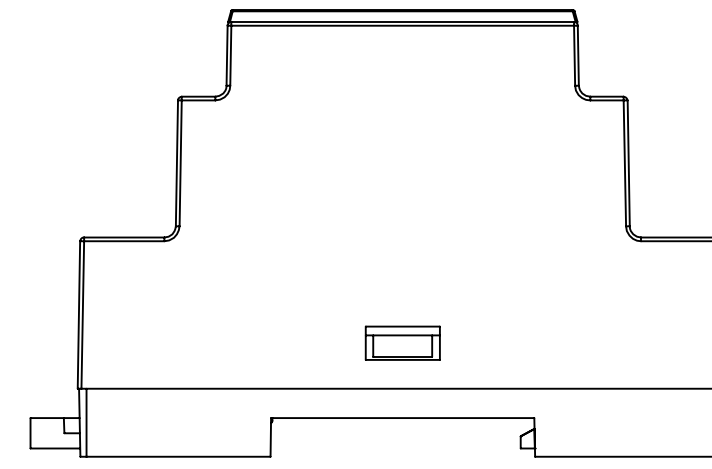

SURFACE-15

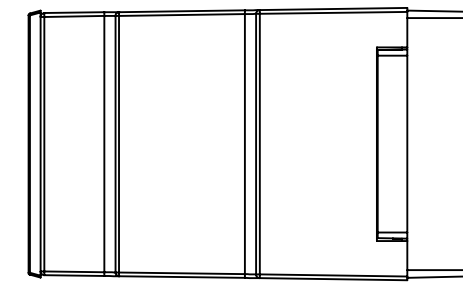
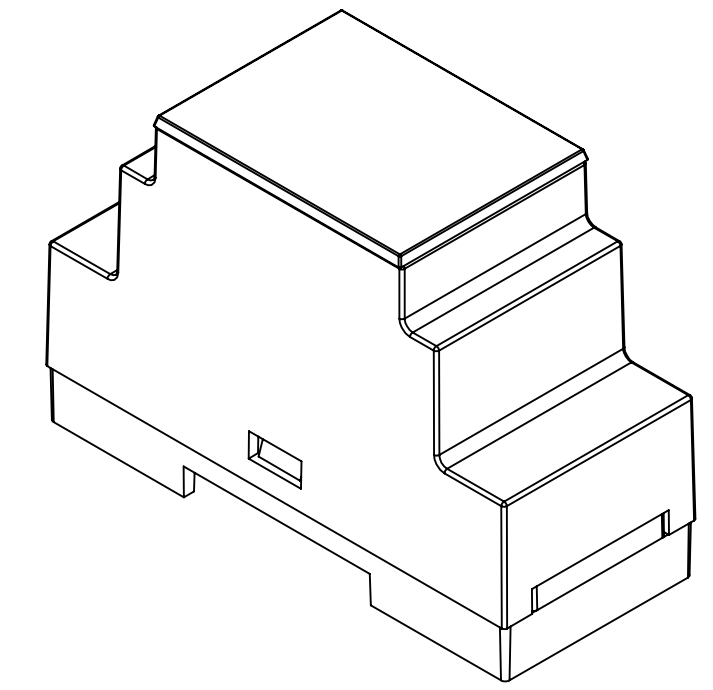

SURFACE-17

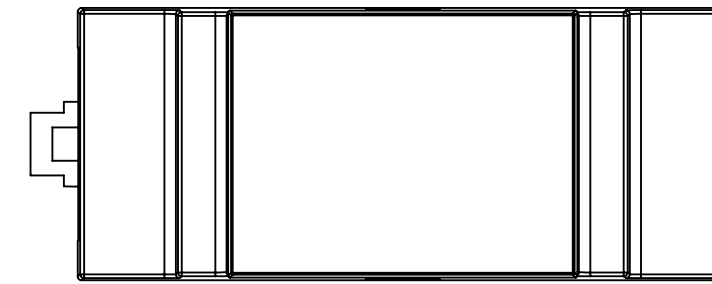

SURFACE-19

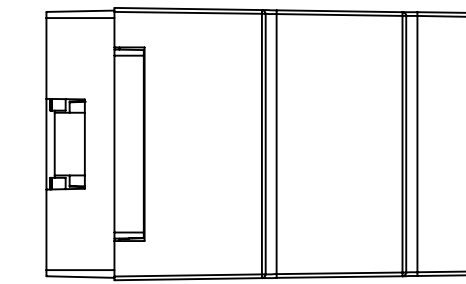

SURFACE-18

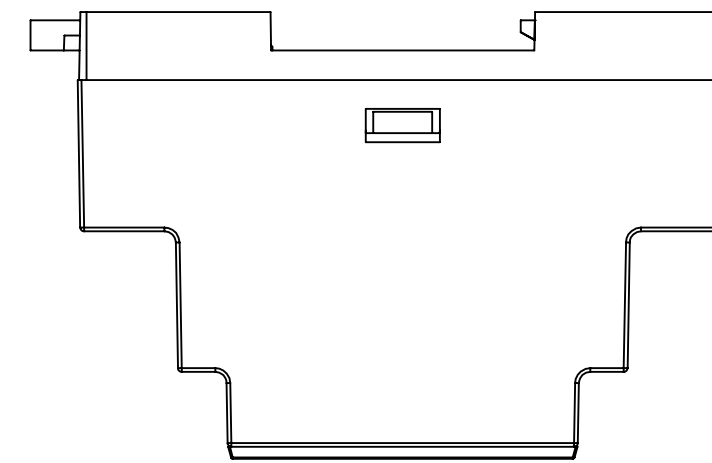

SURFACE-16

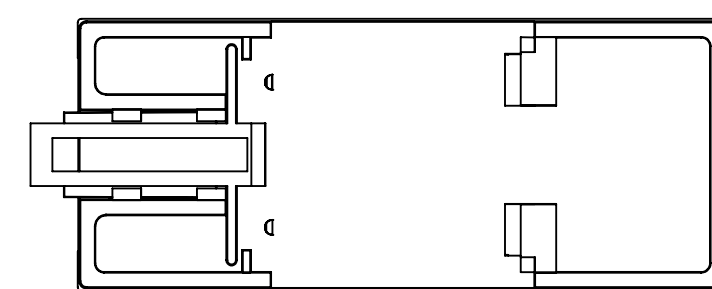
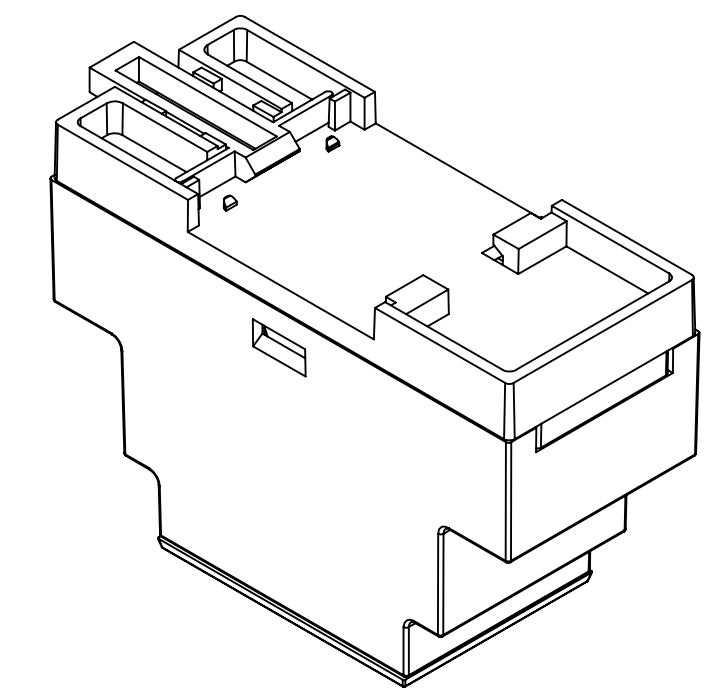

SURFACE-20

REV. NO.	DATE	REVISED BY	DESCRIPTION OF CHANGE
 <span style="float: right;"><a href="http://www.altinkaya.com">www.altinkaya.com</a></span>			
Customer Name:		Customer Ref.:	
Altinkaya Ref.:		Part Name: RT-102-A	
DRAWN	NAME	DATE	Material:
CHECKED	Y. YESLOZ	24.07.2024	Weight:
DIMENSIONAL TOLERANCES UNLESS OTHERWISE SPECIFIED:			SCALE 1:1 UNIT : mm
(DIN7148)	±0.1	±0.1	±0.2 ±0.3 ±0.5
	3-6mm	6-30mm	30-120mm 120-400mm
			Dimension(mm) m(medium)
			SHEET 2 OF 2