

**BASE: 6 SURFACE**

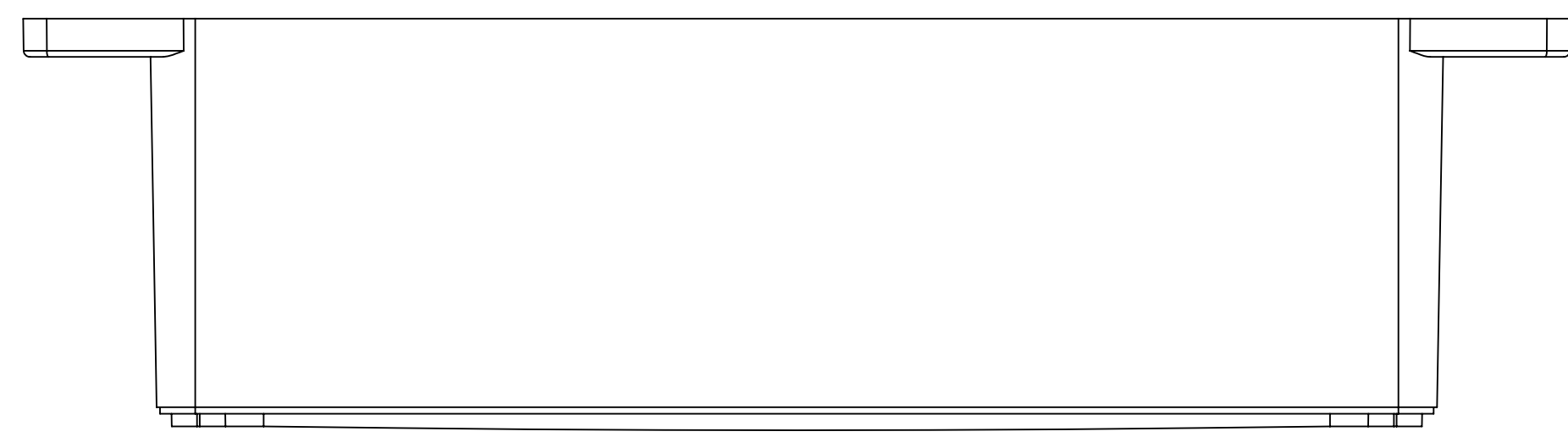

SURFACE-1

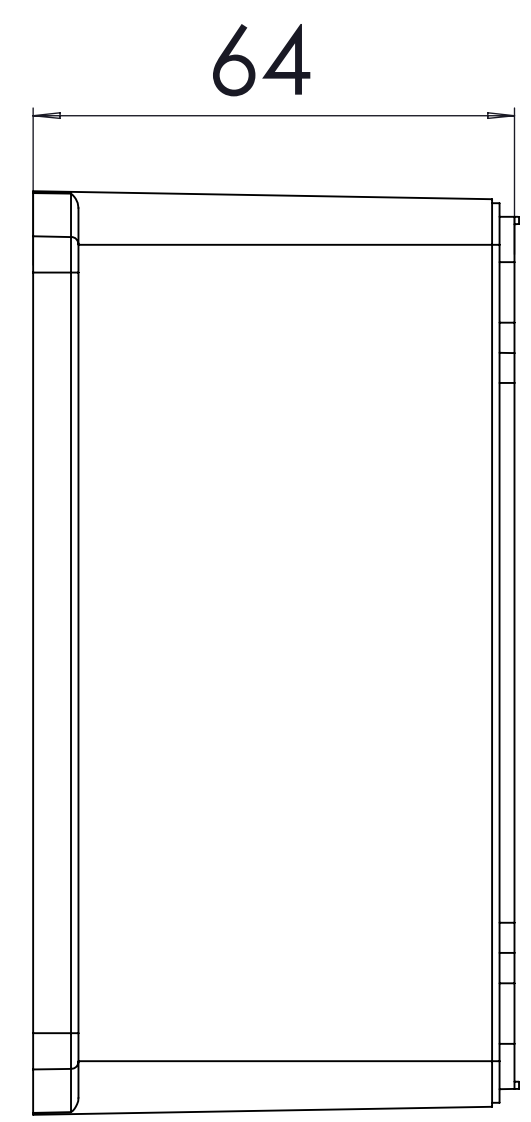

SURFACE-3

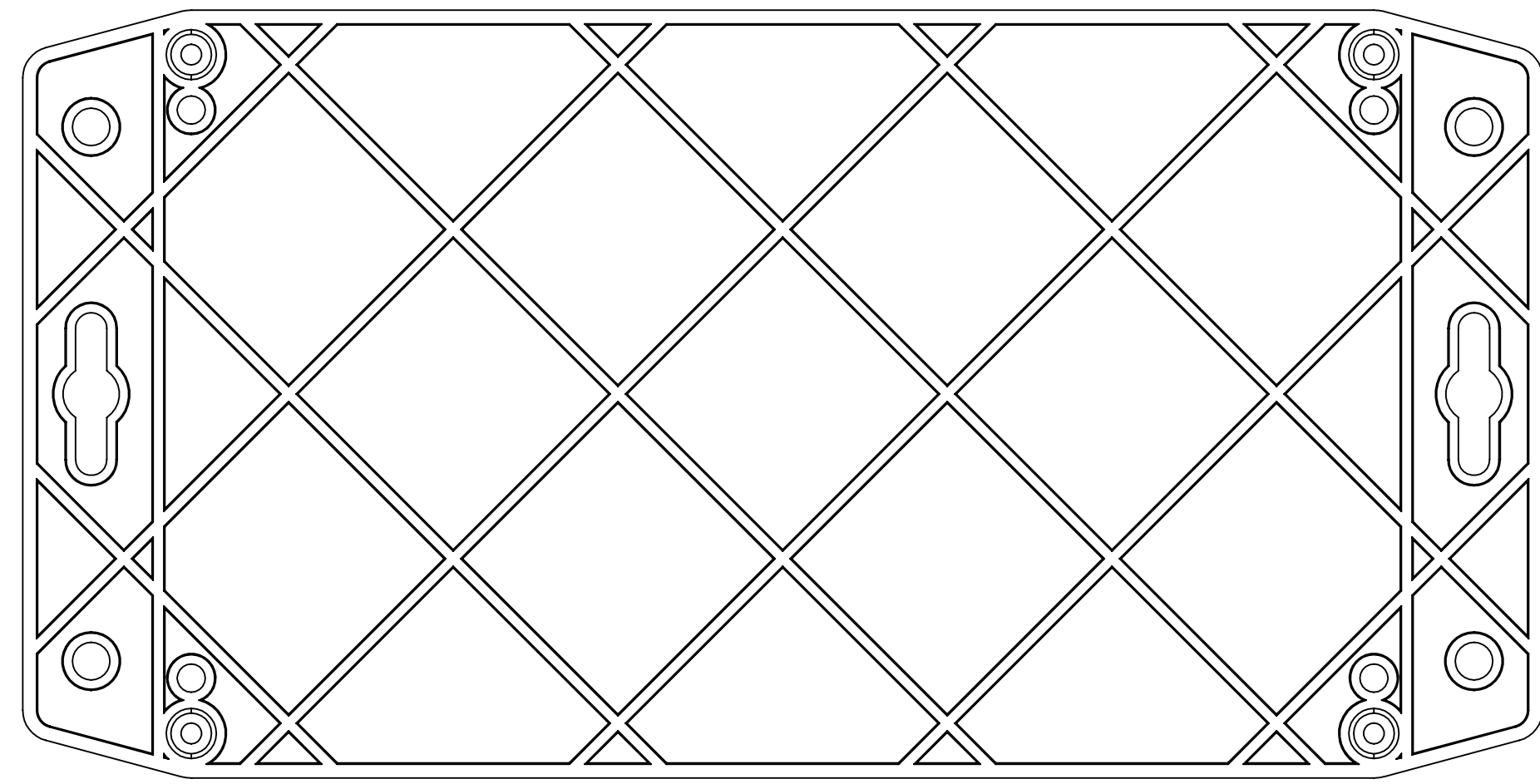

SURFACE-5

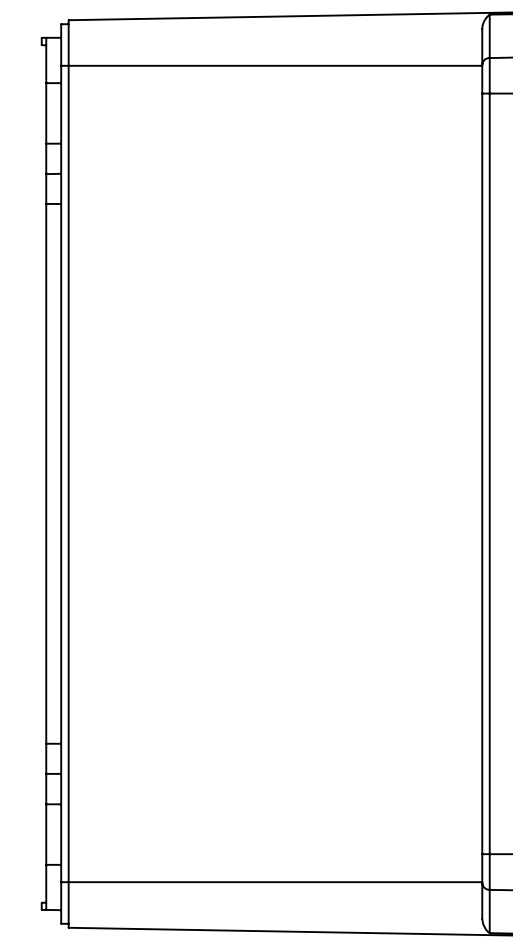

SURFACE-4

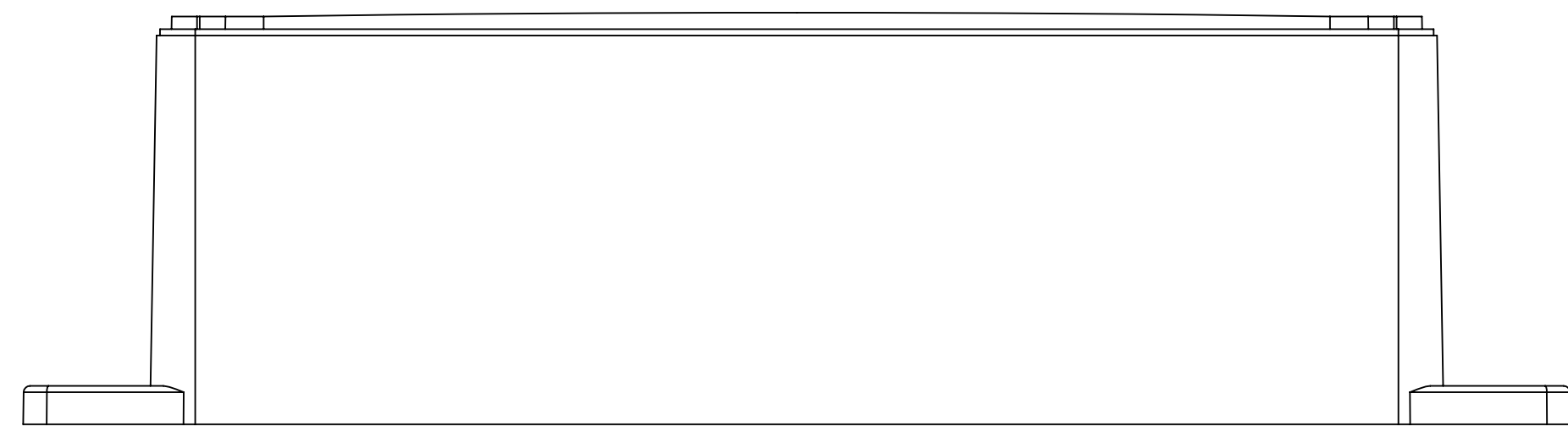

SURFACE-2

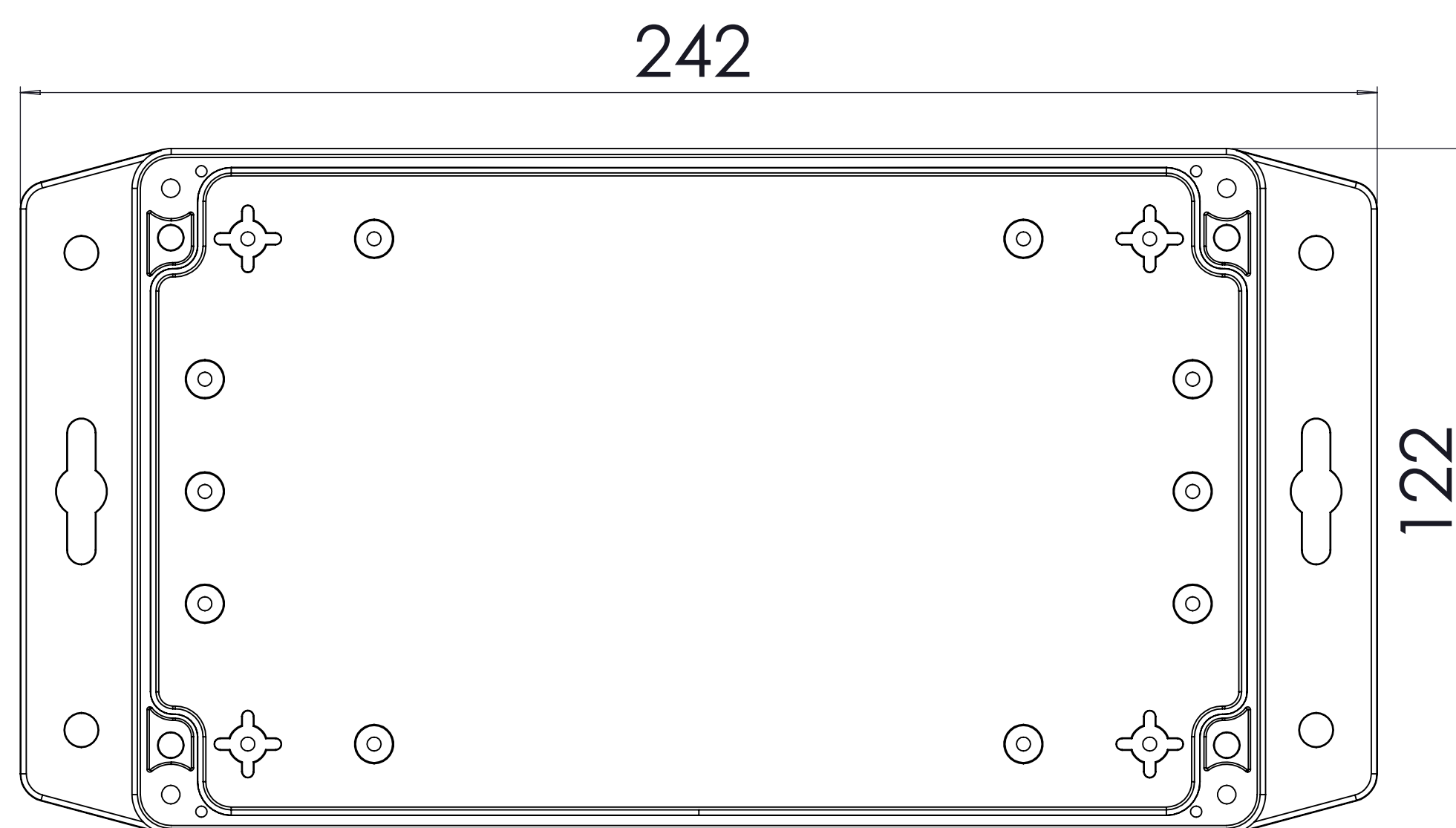
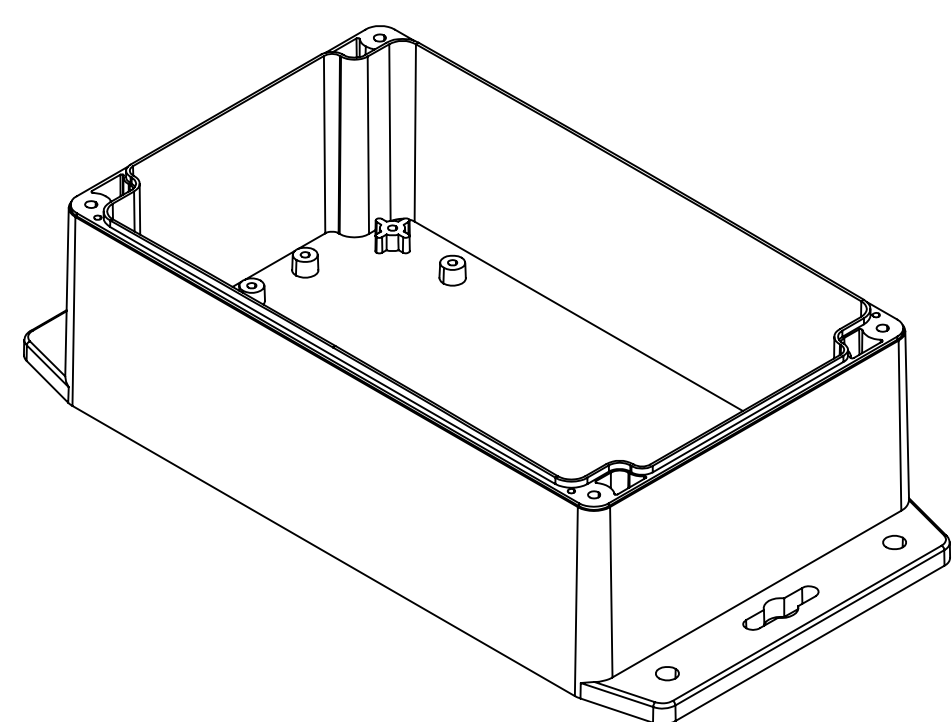

SURFACE-6 (INSIDE)

**COVER: 6 SURFACE**

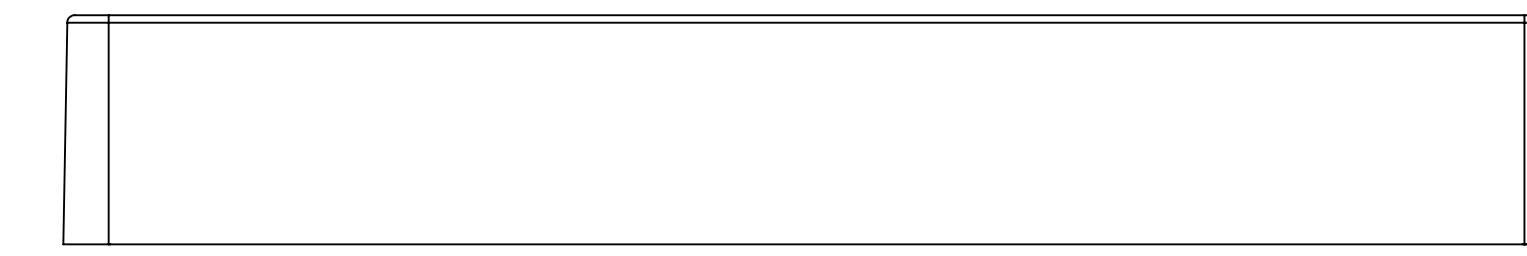

SURFACE-7

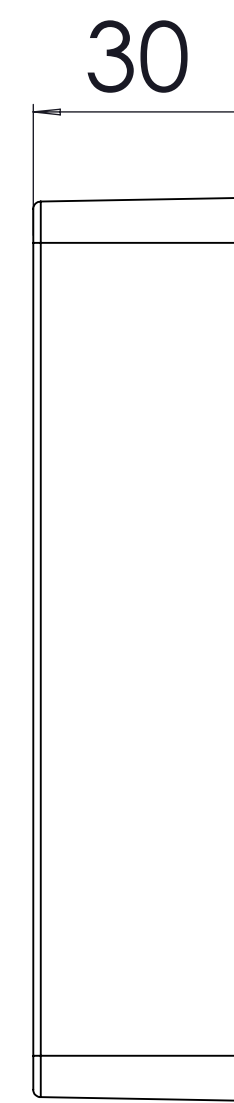

SURFACE-8



SURFACE-10

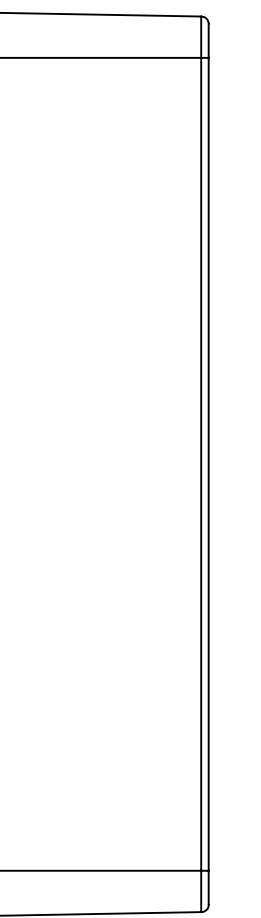

SURFACE-9

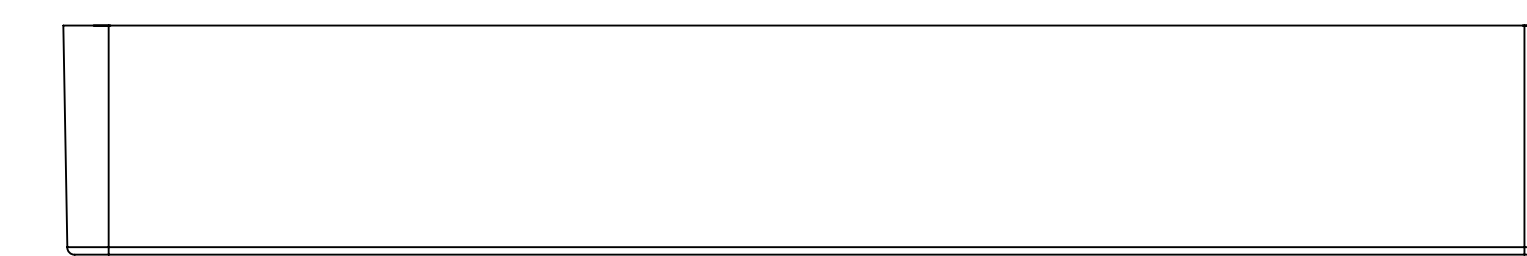

SURFACE-11

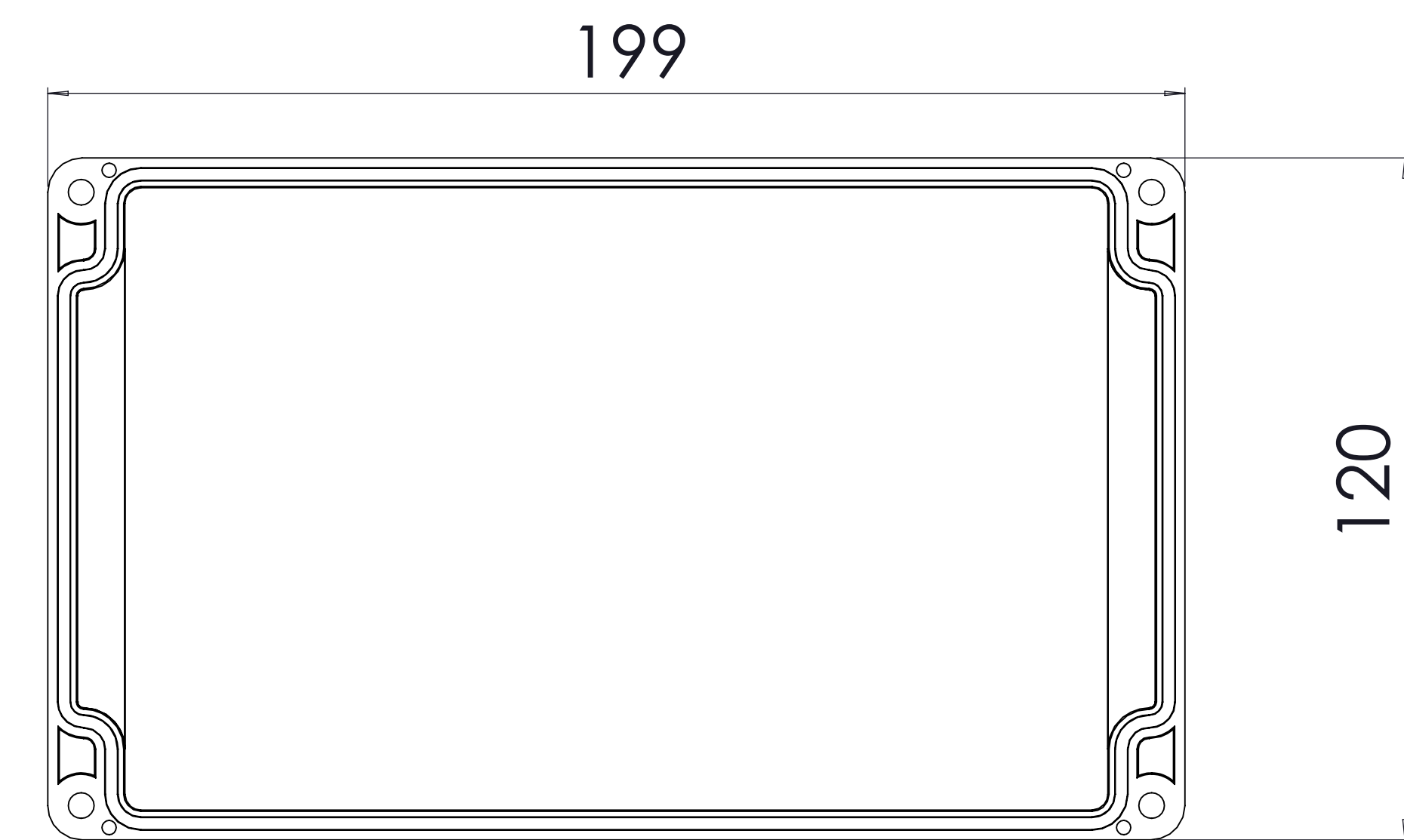

SURFACE-12 (INSIDE)

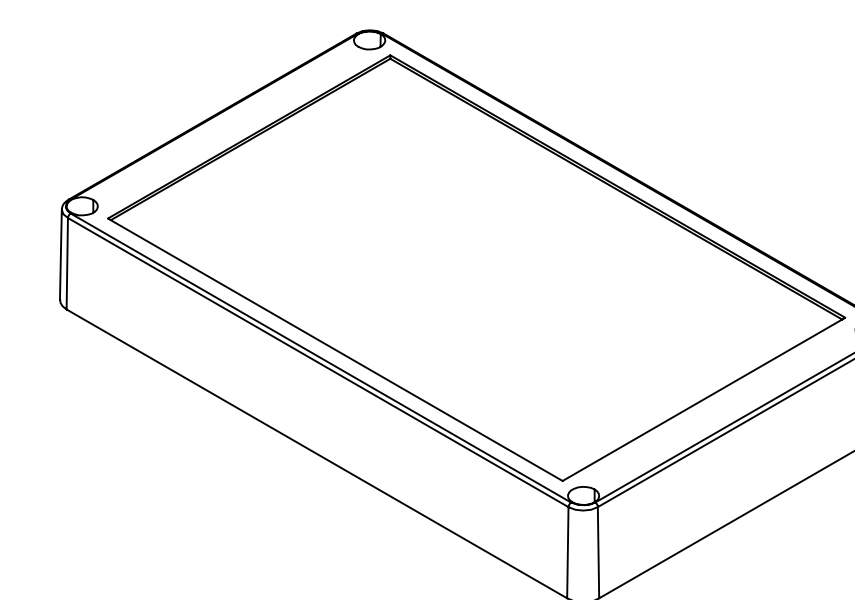

REV. NO	DATE	REVISED BY	DESCRIPTION OF CHANGE
 <b>ALTINKAYA</b> Electronic Enclosures & Components			<a href="http://www.altinkaya.com">www.altinkaya.com</a>
Customer Name:		Customer Ref.:	
Altinkaya Ref.:		Part Name: SF-242-0-0	
DRAWN	NAME	DATE	Drawn From:
CHECKED	Y.YEL	6.07.2024	Weight:
DIMENSIONAL TOLERANCES UNLESS OTHERWISE SPECIFIED (DIN7168)			
0.5-3mm	3-6mm	6-30mm	30-120mm
±0.1	±0.1	±0.2	±0.3
			120-400mm
			±0.5
			m (Medium)
			SCALE 1:1
			SHEET 1 OF 2
			UNIT: mm
			A0

**SF-242 IF MACHINED TOGETHER**

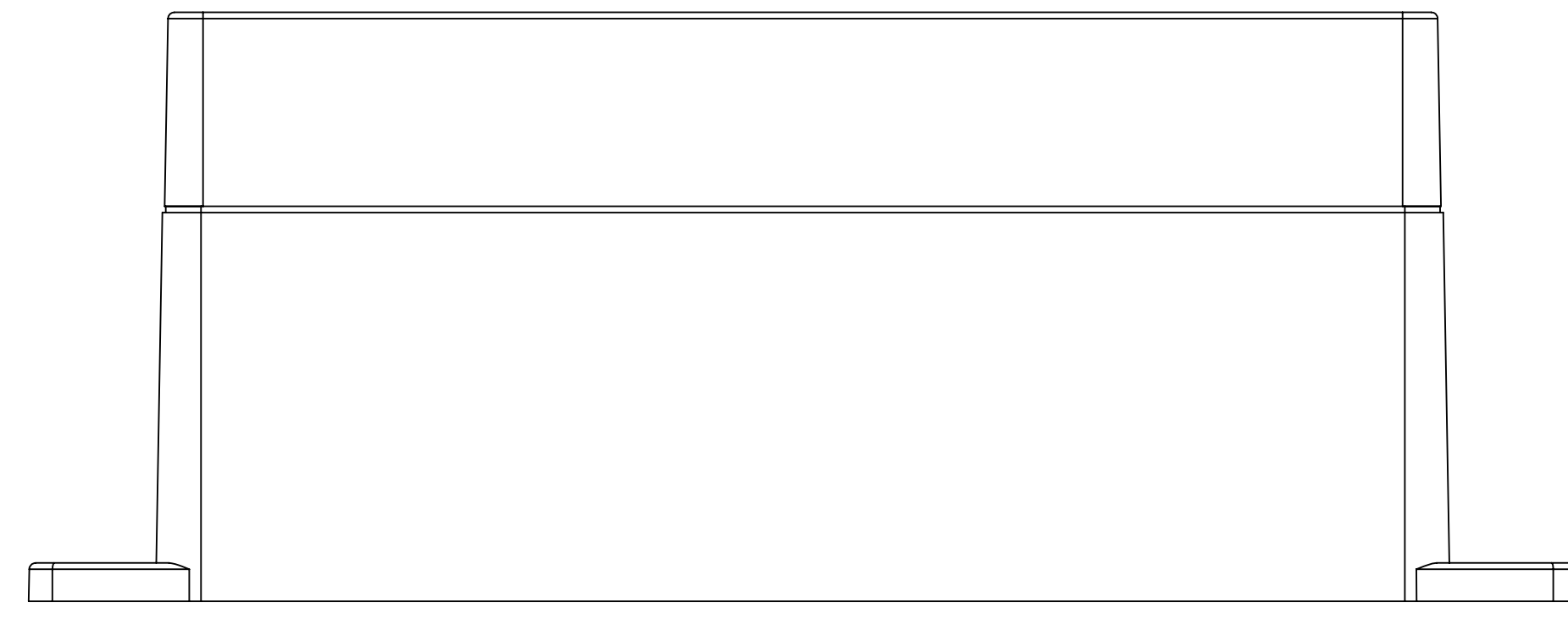

SURFACE-13

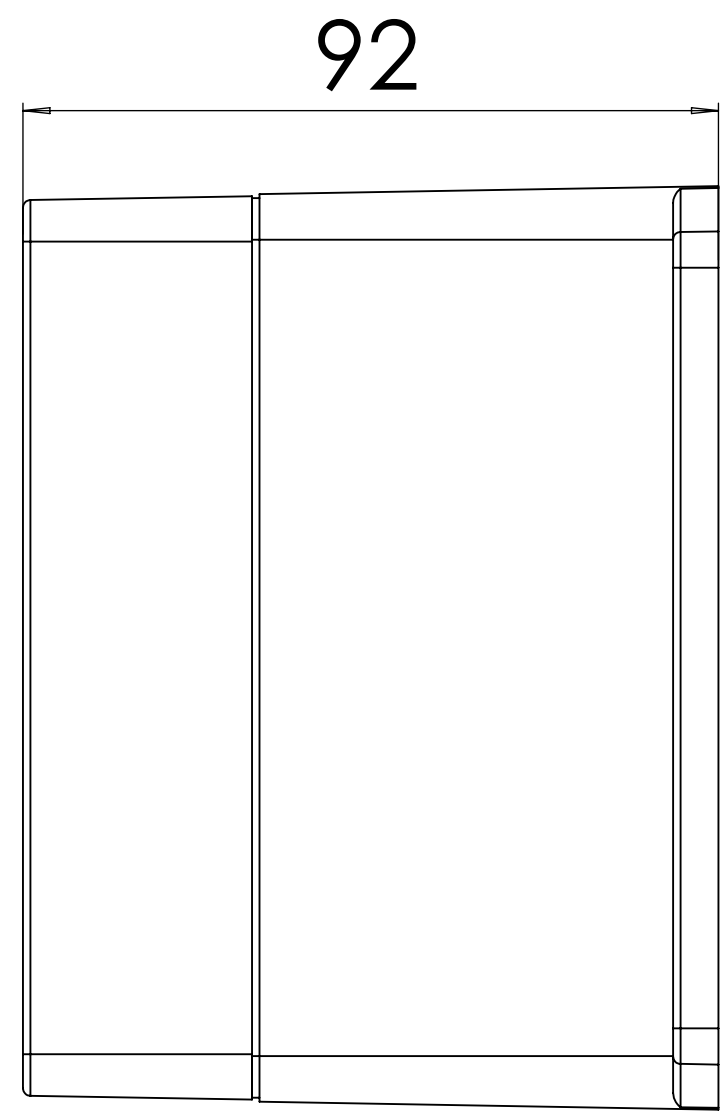
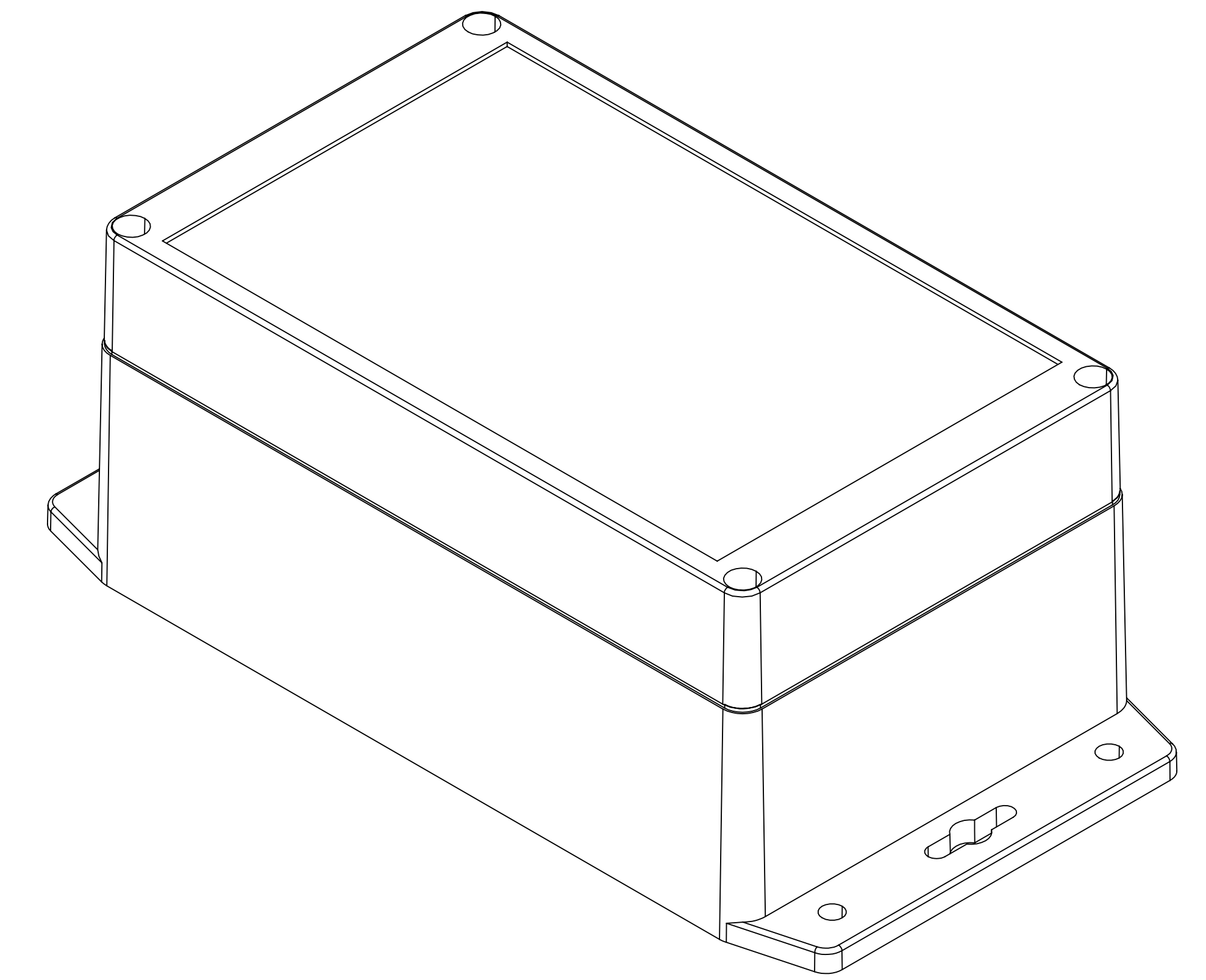

SURFACE-15

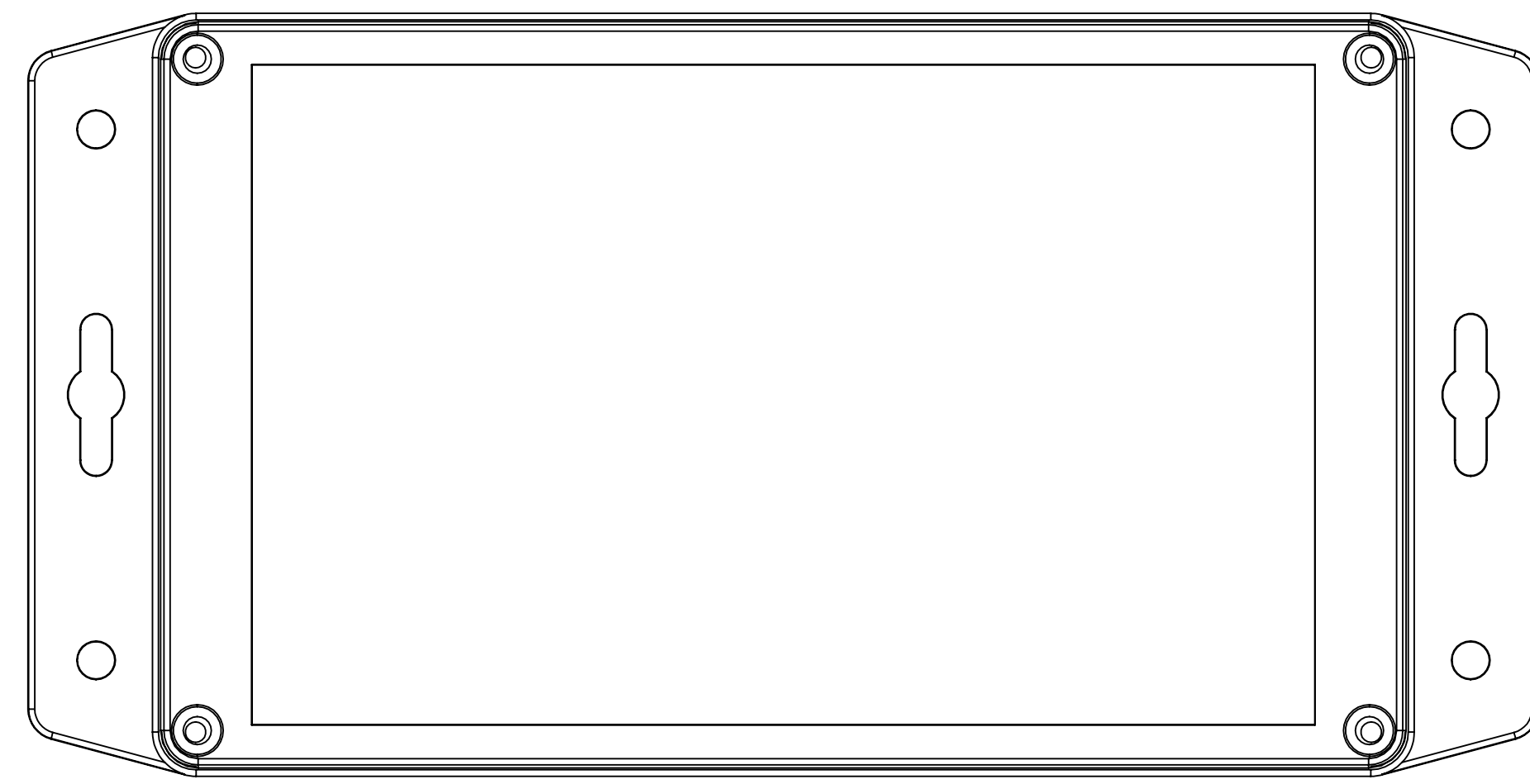

SURFACE-17

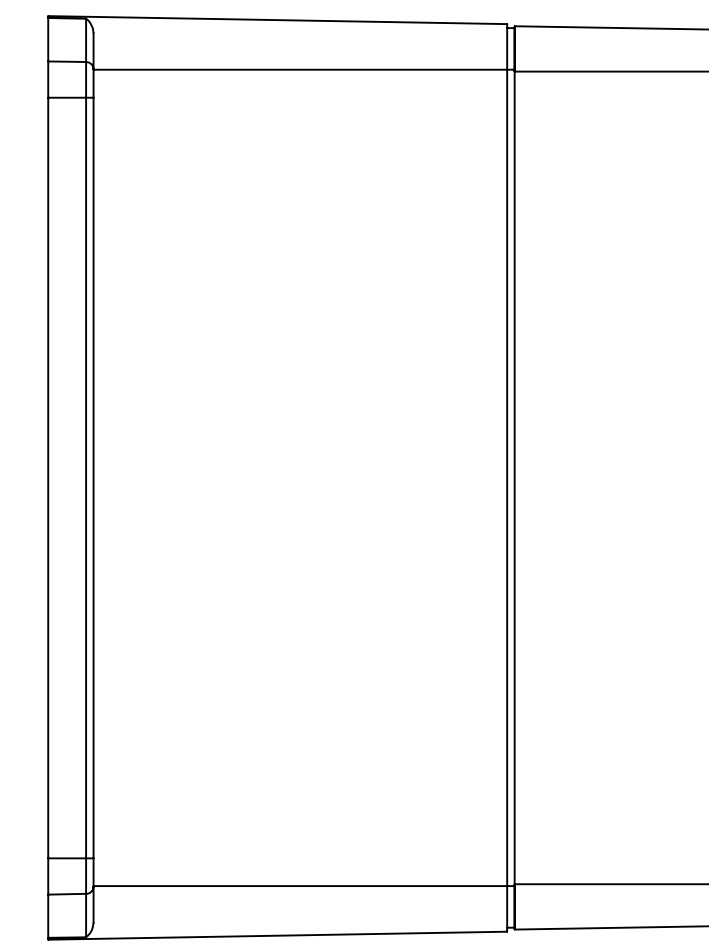

SURFACE-16

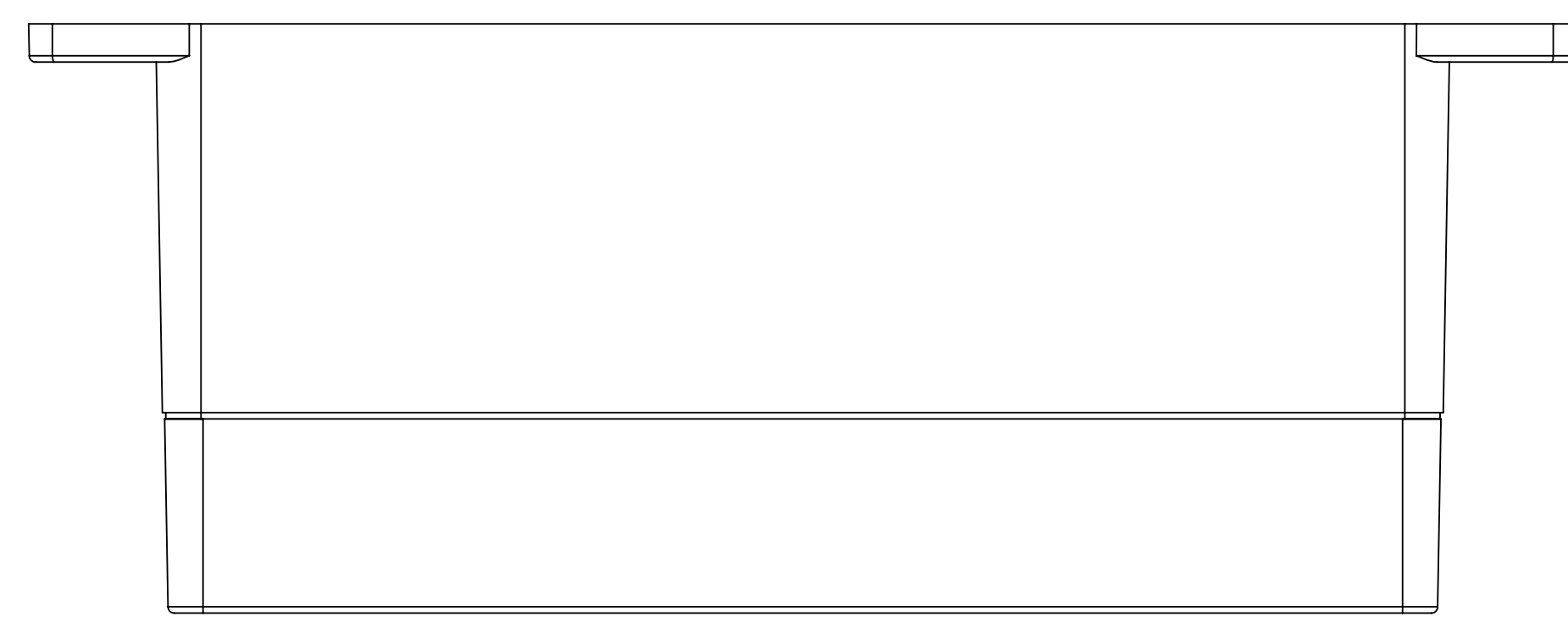

SURFACE-14

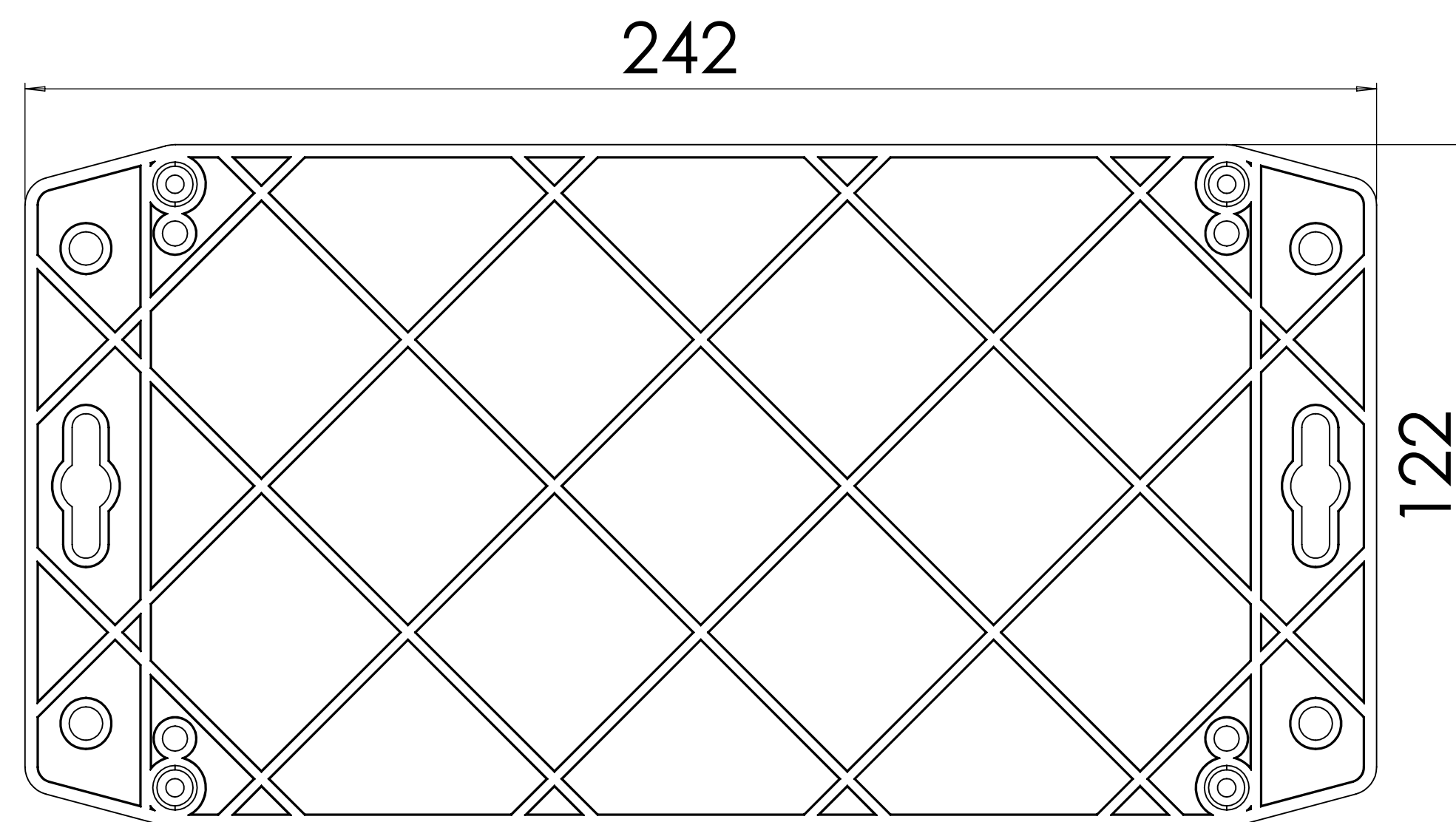
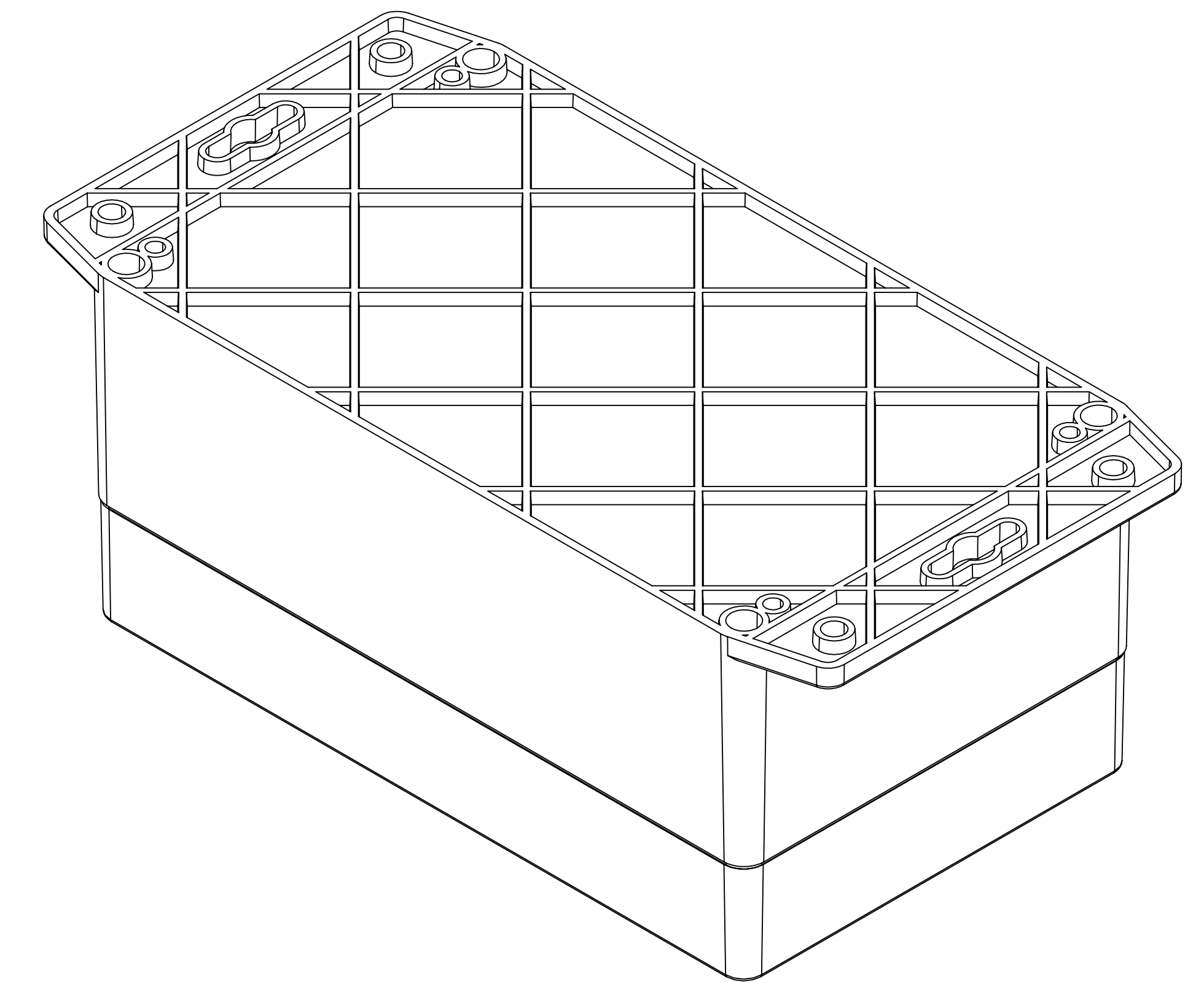

SURFACE-18

REV. NO	DATE	REVISED BY	DESCRIPTION OF CHANGE	
 <b>ALTINKAYA</b> Electronic Enclosures & Components			<a href="http://www.altinkaya.com">www.altinkaya.com</a>	
Customer Name:		Customer Ref.:		
Altinkaya Ref.:		Part Name: SF-242-0-0		
DRAWN	NAME	DATE	Drawn From:	SCALE 1:1
CHECKED	Y.YEL	6.07.2024	Material:	SHEET 2 OF 2
DIMENSIONAL TOLERANCES UNLESS OTHERWISE SPECIFIED (DIN7168)			Weight:	UNIT: mm
	0.5-3mm	3-6mm	6-30mm	30-120mm
	±0.1	±0.1	±0.2	±0.3
			±0.5	±0.5
				m (Medium)