

BASE: 6 SURFACE

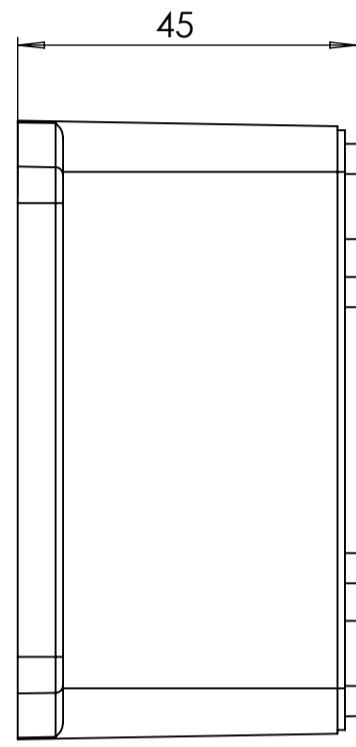

SURFACE-1



SURFACE-3

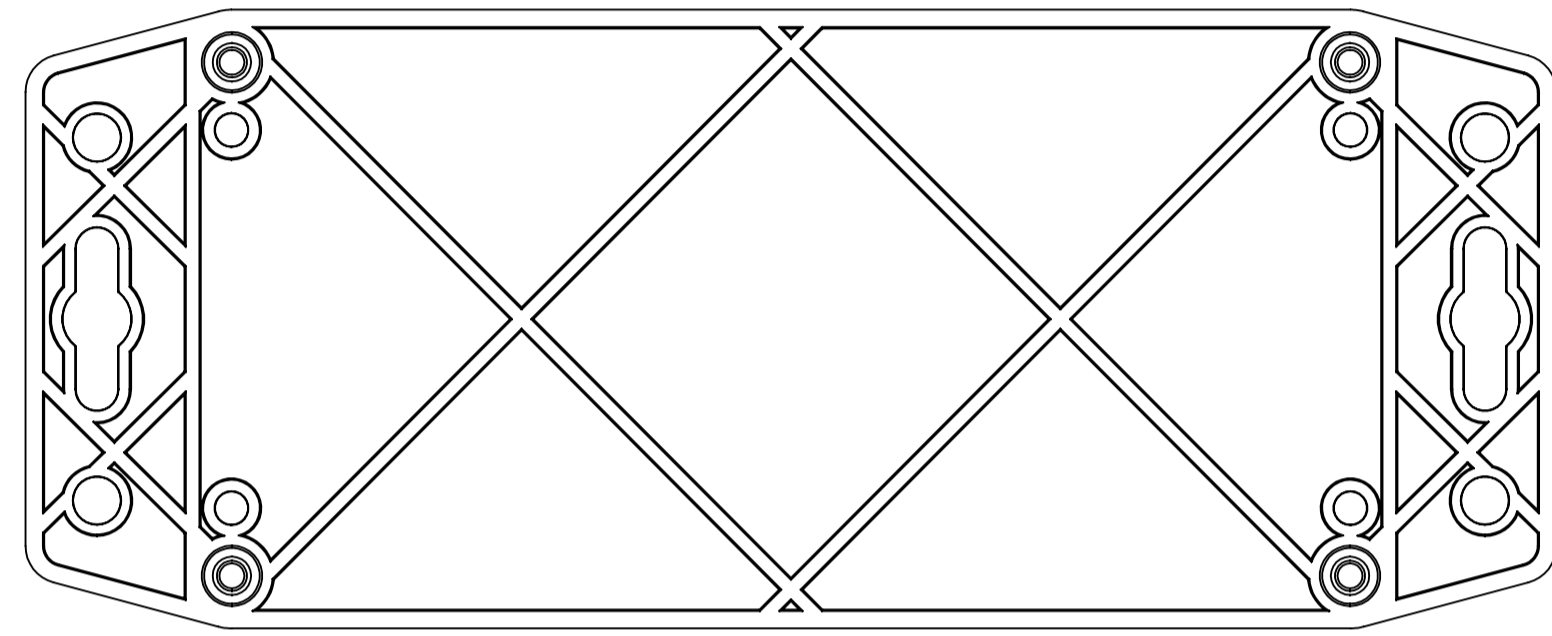

SURFACE-5

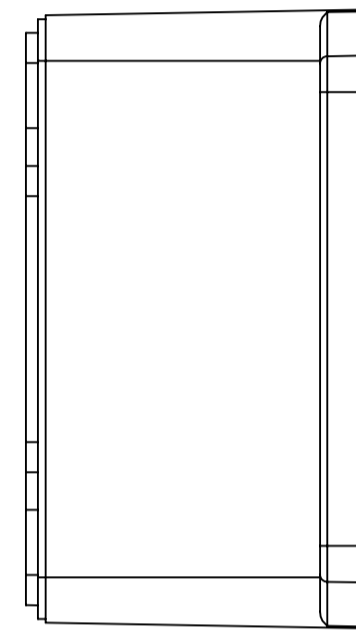

SURFACE-4

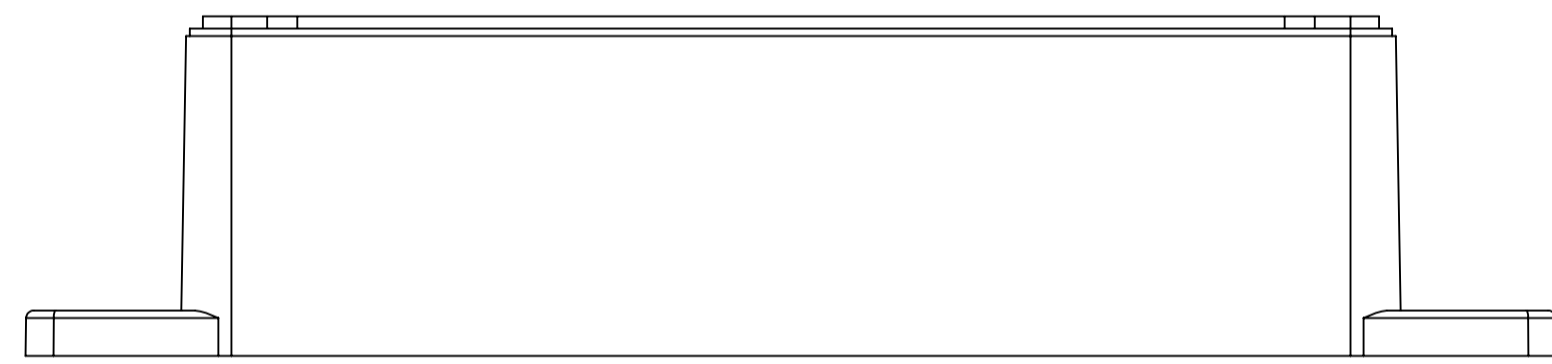

SURFACE-2

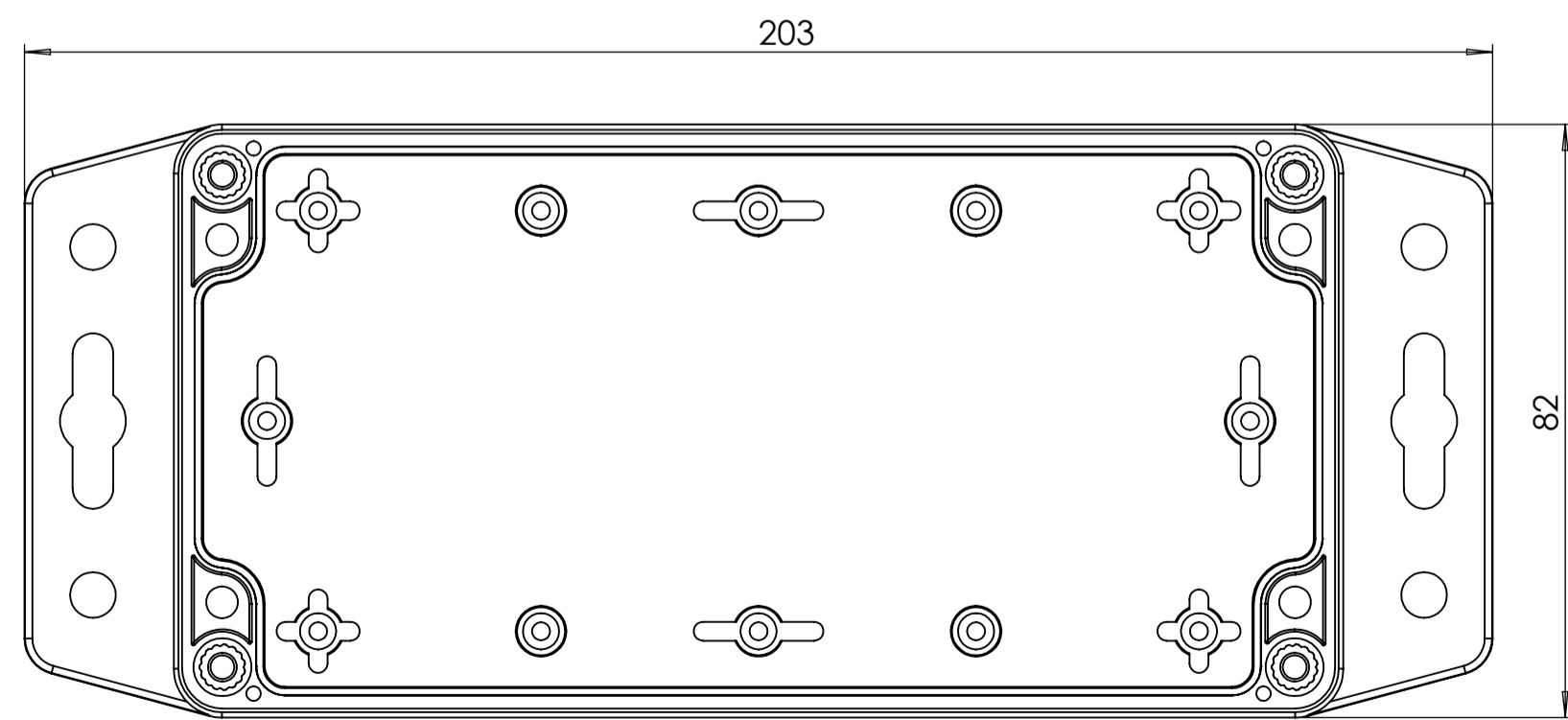

SURFACE-6 (INSIDE)

COVER: 6 SURFACE

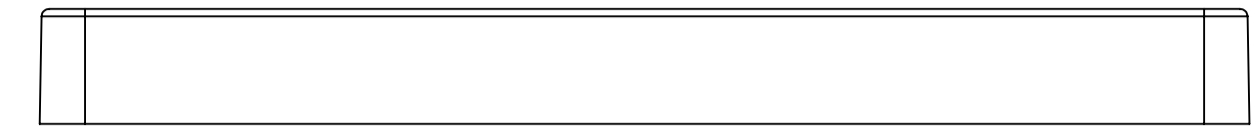

SURFACE-7

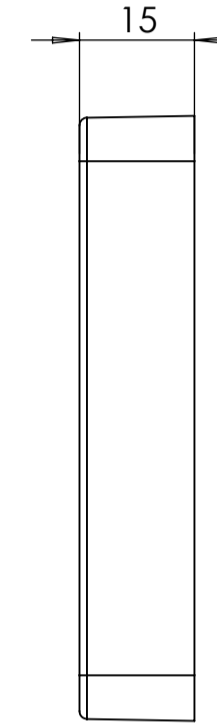

SURFACE-9

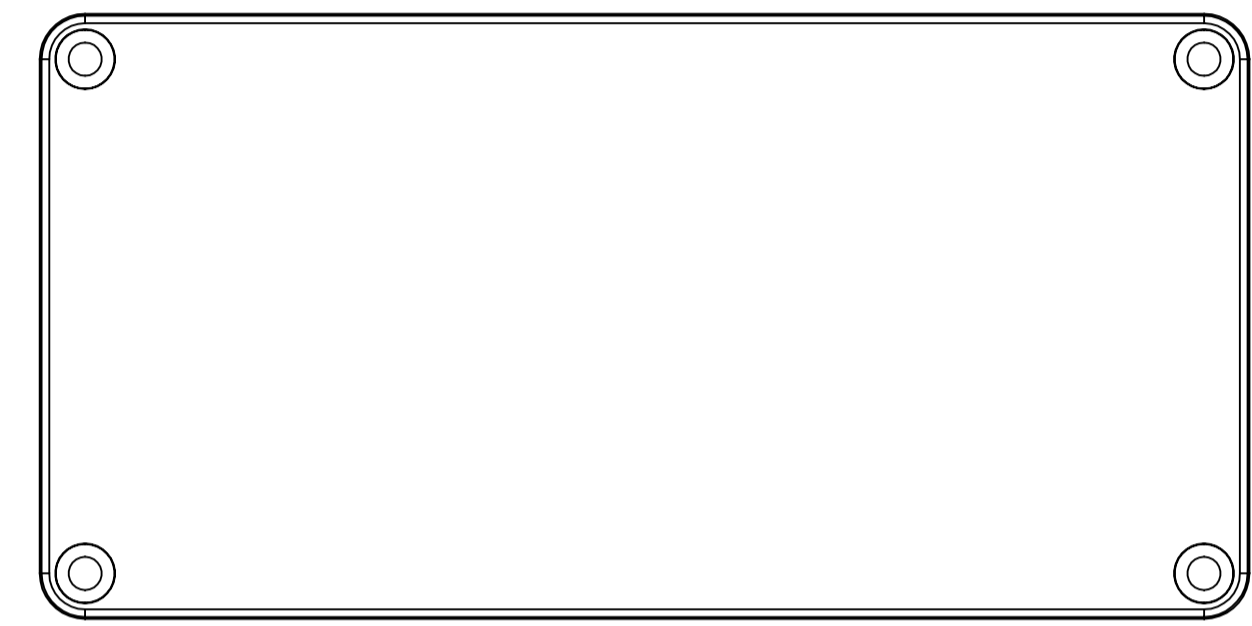

SURFACE-11

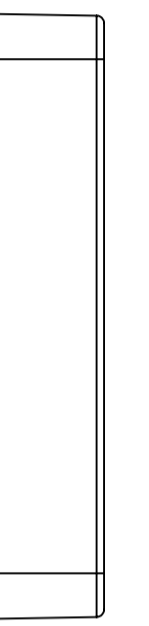

SURFACE-10

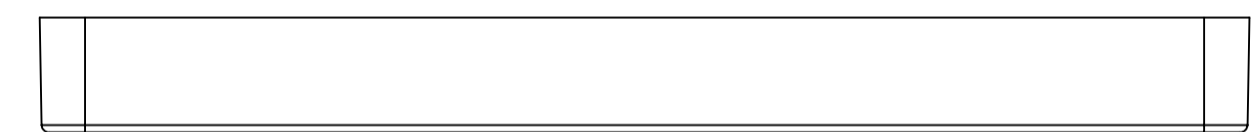

SURFACE-8

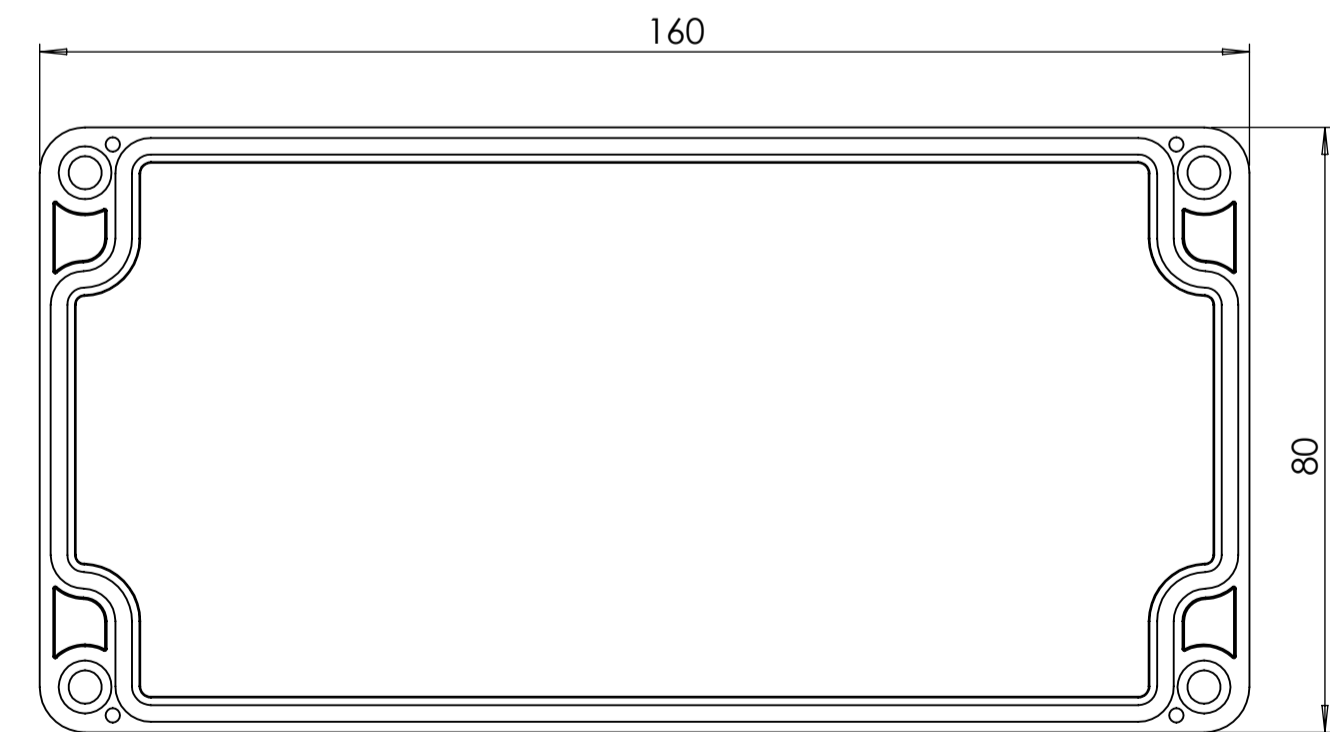

SURFACE-12 (INSIDE)

REV. NO.	DATE	REVISED BY	DESCRIPTION OF CHANGE
 ALTINKAYA Electronic Enclosures & Components www.altinkaya.com			
Customer Name:		Customer Ref.:	
Altinkaya Ref.:		Part Name: SF-226-0-0	
DRAWN	NAME	DATE	Drawn From:
CHECKED	Y. YEL	5.07.2024	Material:
DIMENSIONAL TOLERANCES UNLESS OTHERWISE SPECIFIED:			Weight:
[DIN7148]	±0.1	±0.1	±0.2
	3-6mm	6-30mm	30-120mm
		120-400mm	
			±0.5
			SCALE 1:1 UNIT : mm
			Dimension(mm)
			m(medium)
			SHEET 1 OF 2

SF-226 IF MACHINED TOGETHER

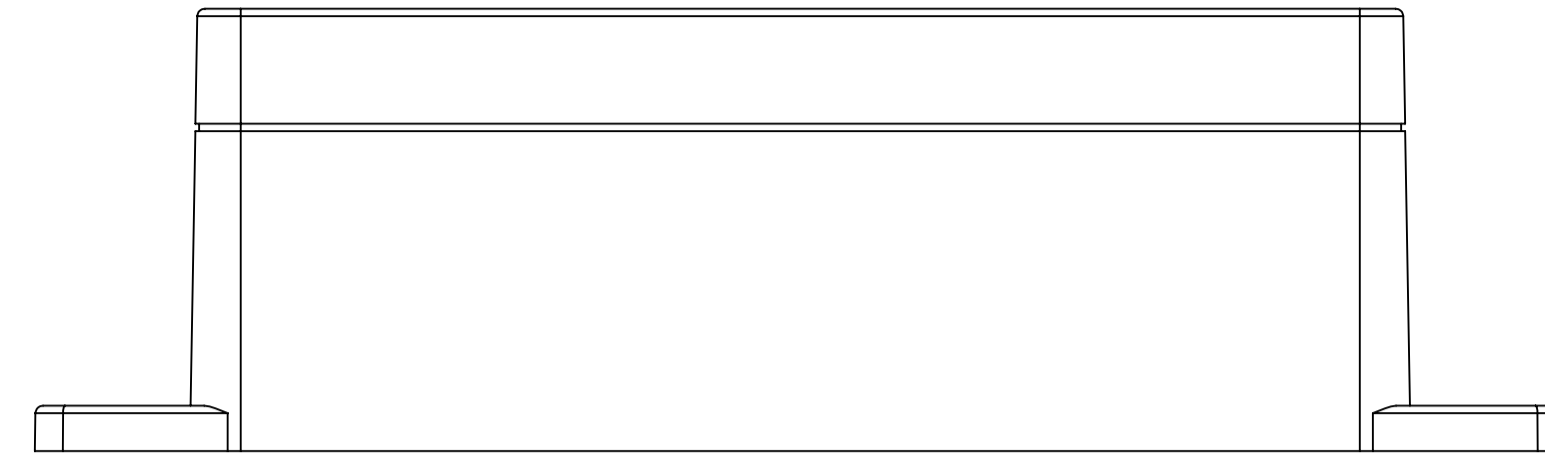

SURFACE-13

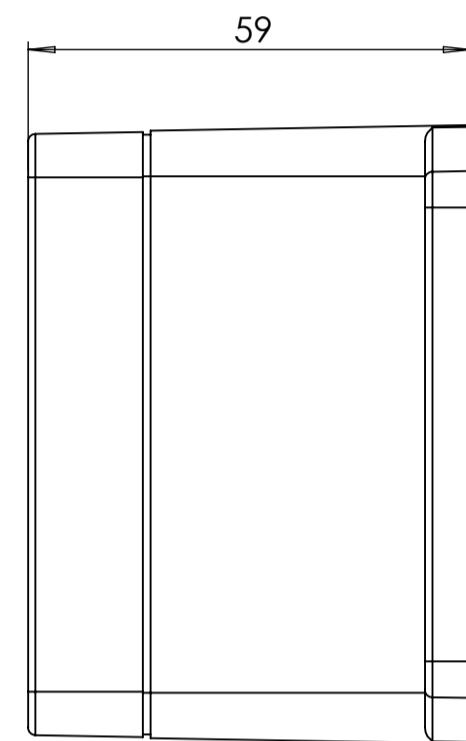

SURFACE-15

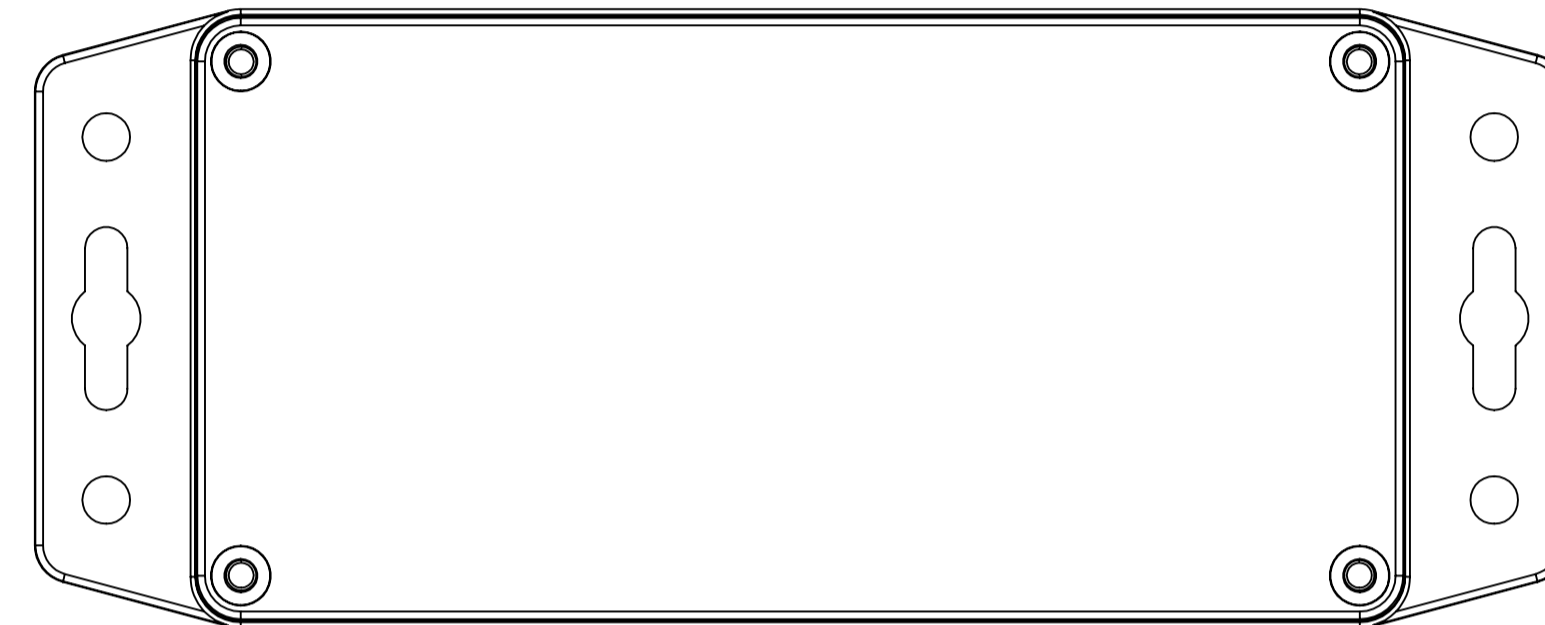

SURFACE-17

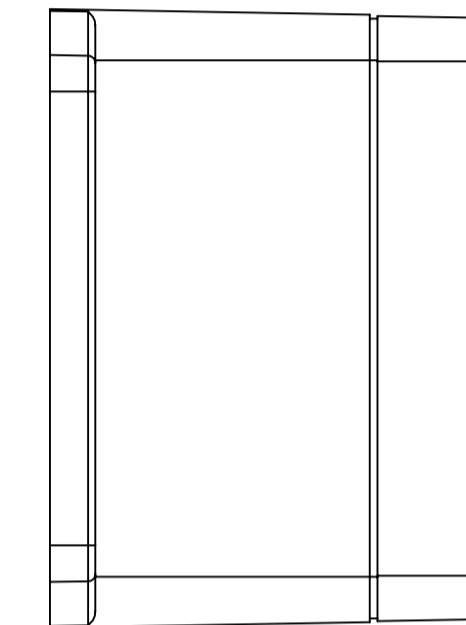

SURFACE-16

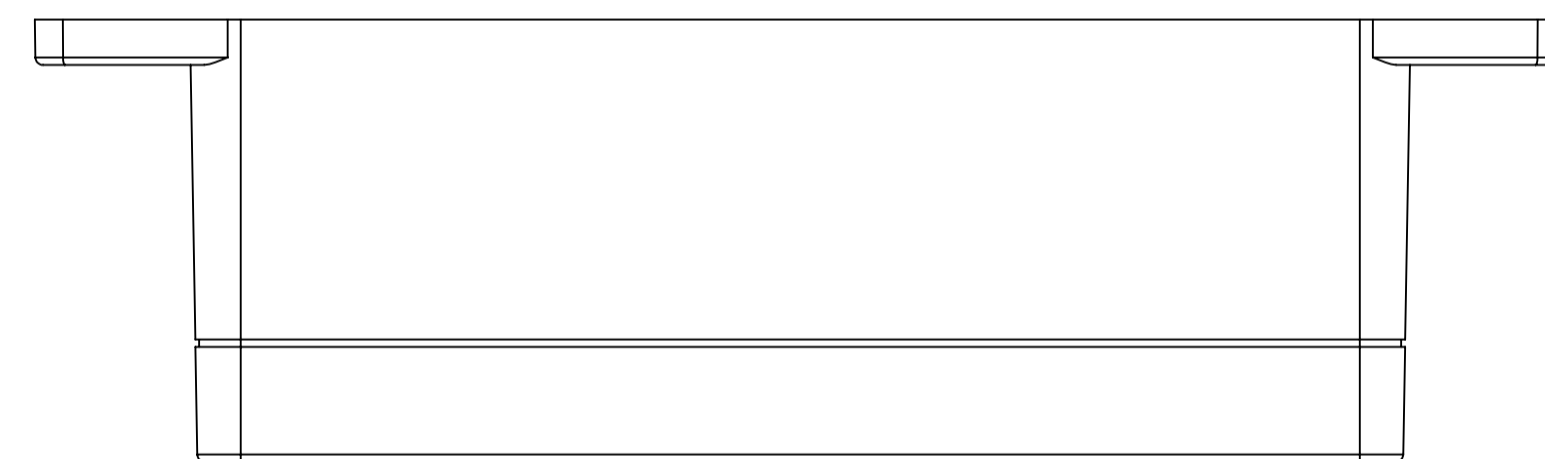
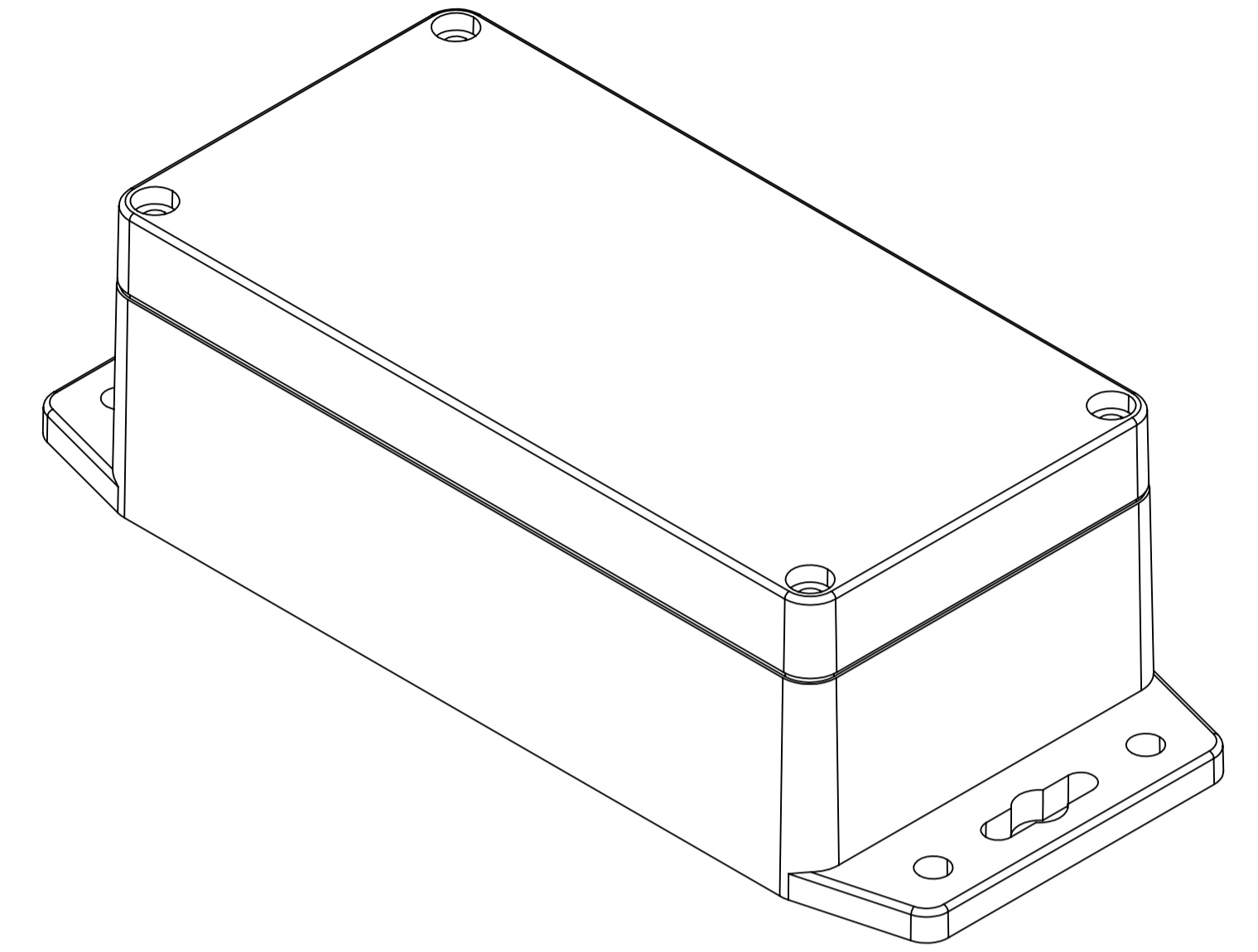

SURFACE-14

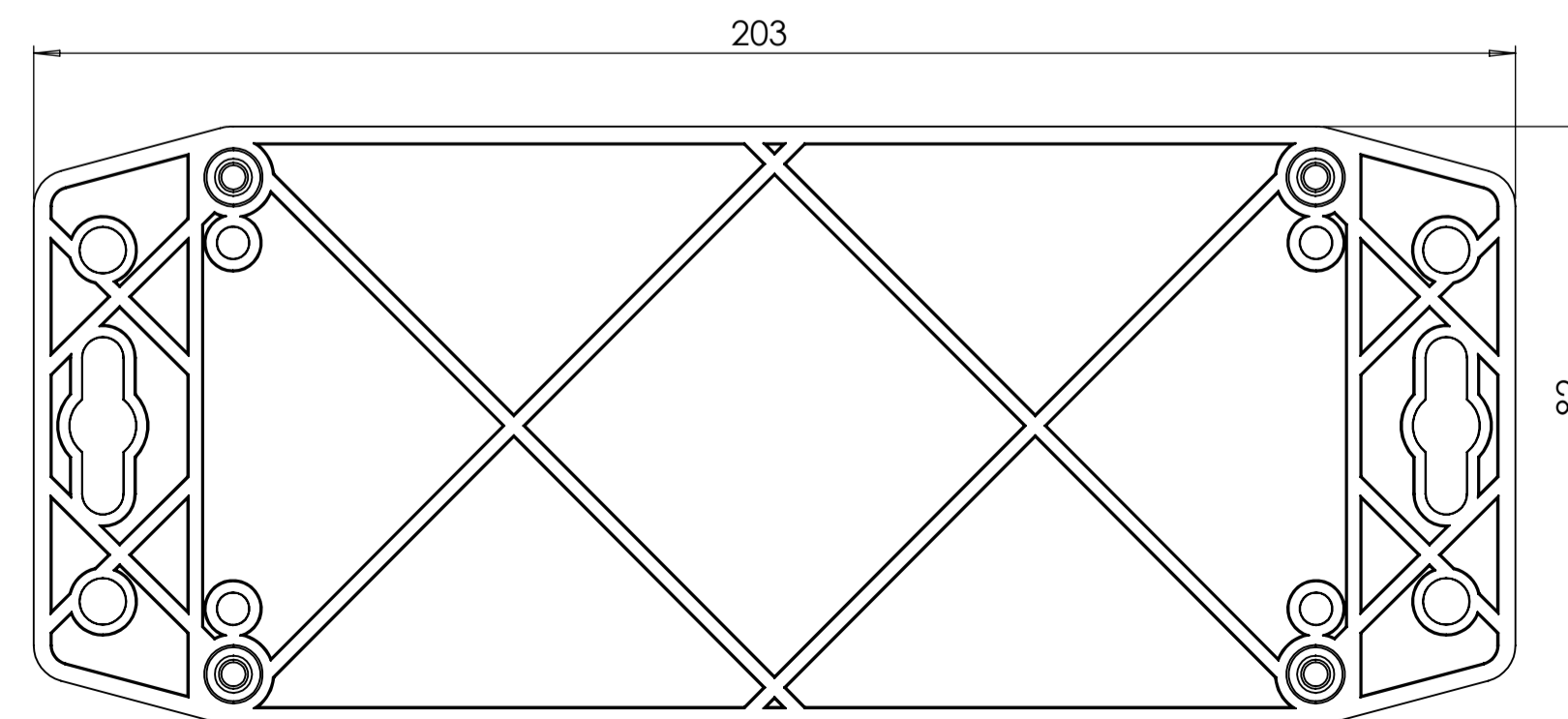
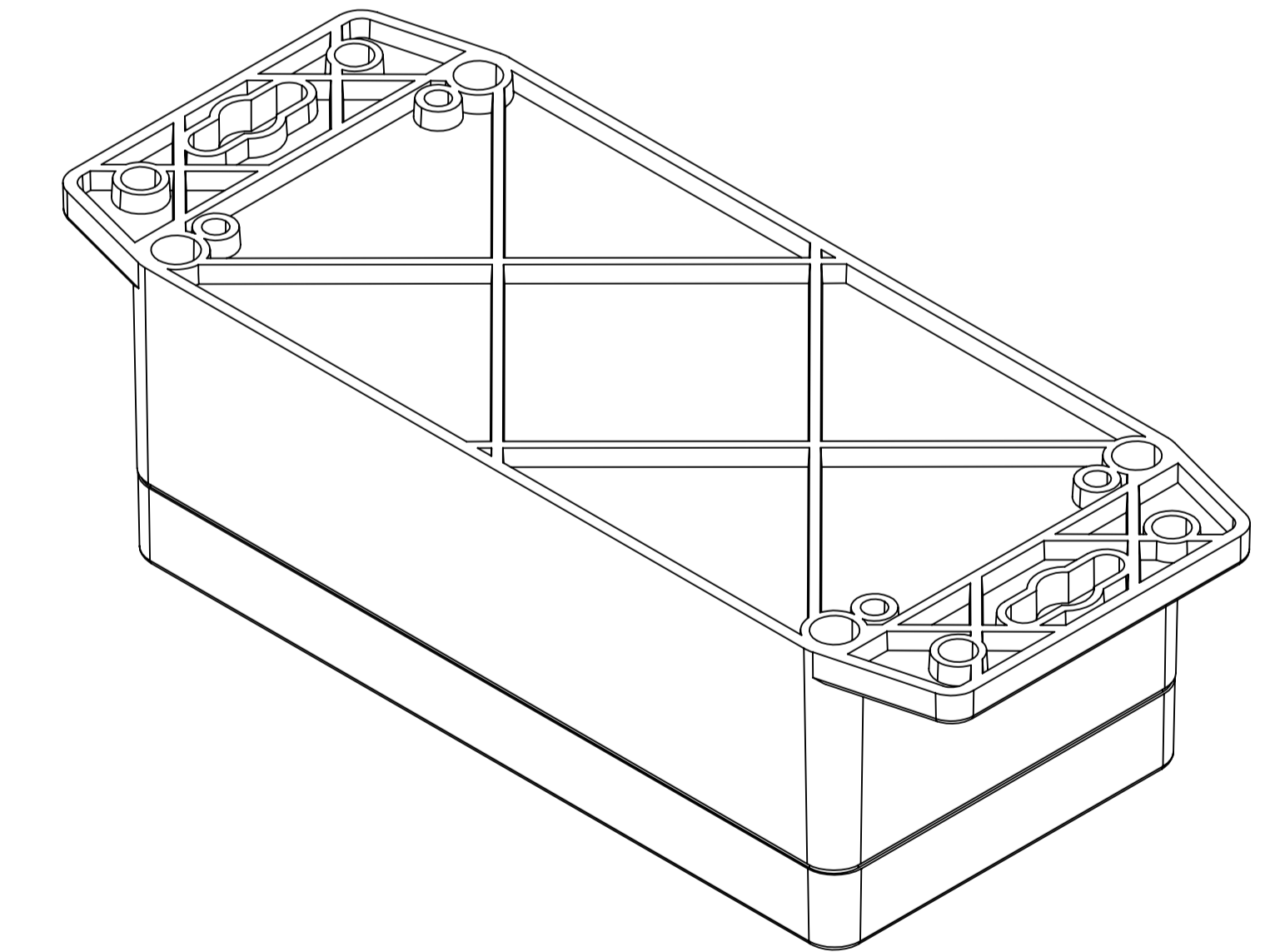

SURFACE-18

REV. NO.	DATE	REVISED BY	DESCRIPTION OF CHANGE
 www.altinkaya.com			
Customer Name:		Customer Ref.:	
Altinkaya Ref.:		Part Name: SF-226-0-0	
DRAWN	NAME	DATE	Material:
CHECKED	Y. YESLOZ	5.07.2024	Weight:
DIMENSIONAL TOLERANCES UNLESS OTHERWISE SPECIFIED:			SCALE 1:1 UNIT : mm
(R&T/148)	±0.1	±0.1	±0.2 ±0.3 ±0.5
	3-6mm	6-30mm	30-120mm 120-400mm
			Dimension(mm) m(medium)