

BASE: 6 SURFACE

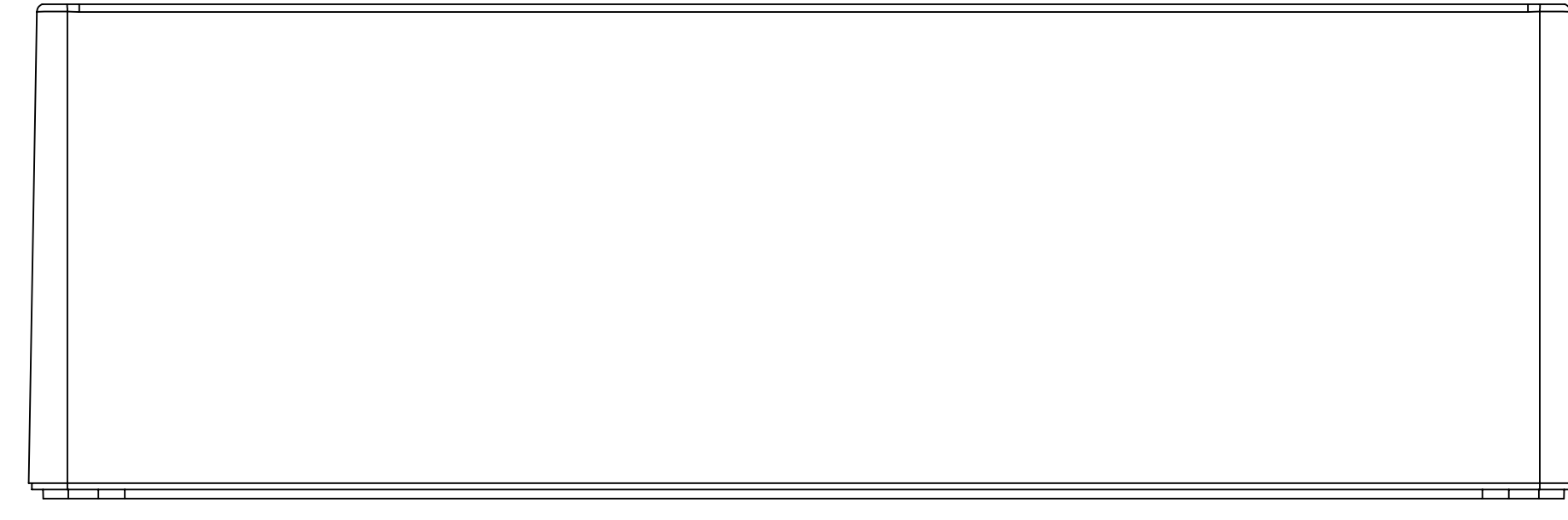

SURFACE-1

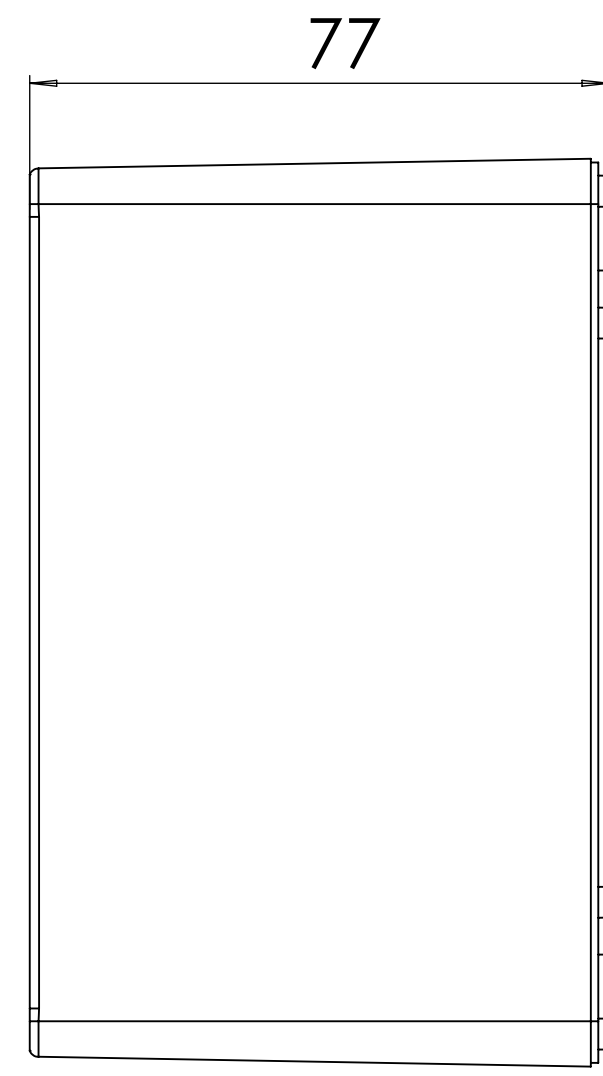

SURFACE-3

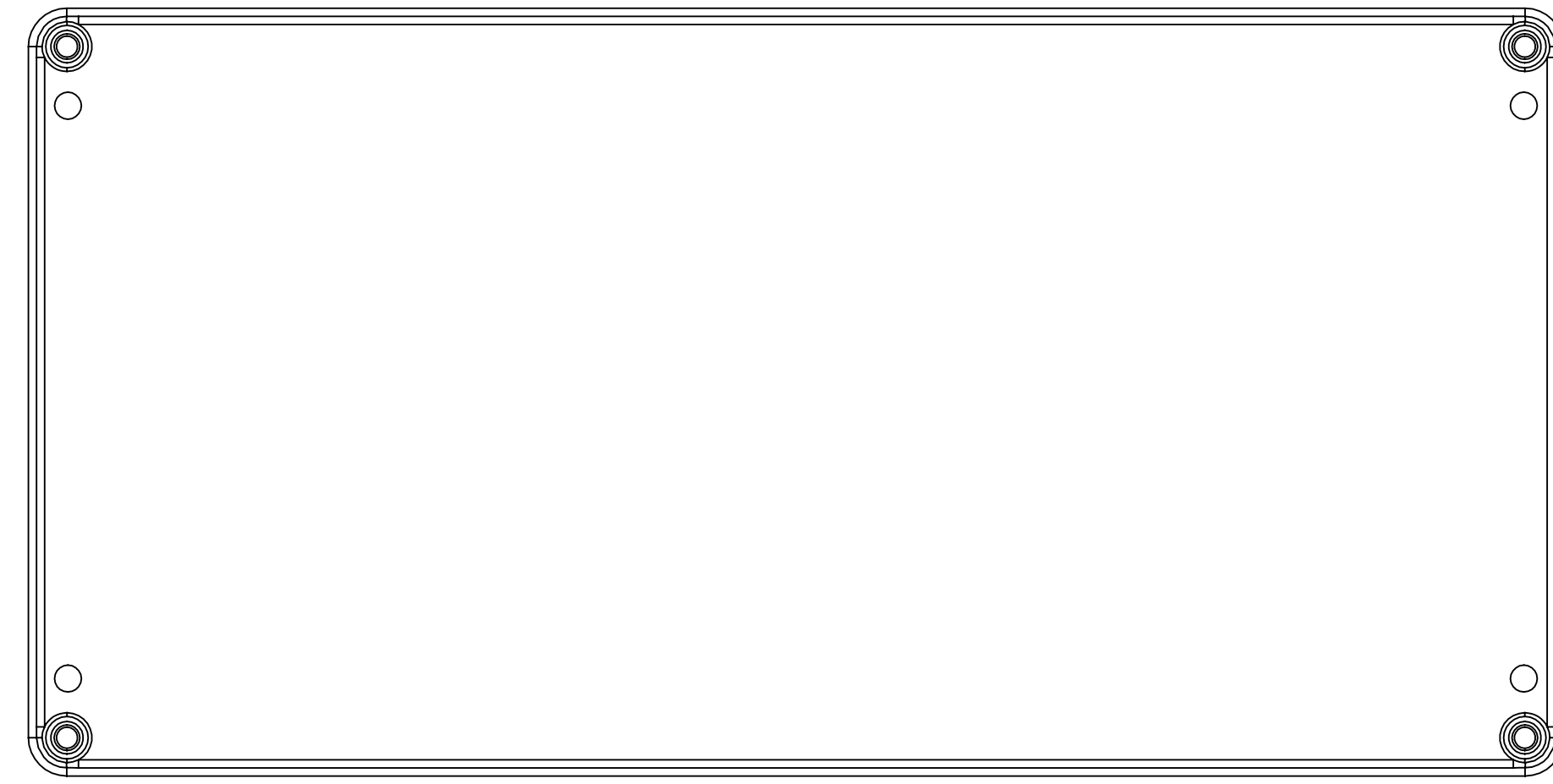

SURFACE-5

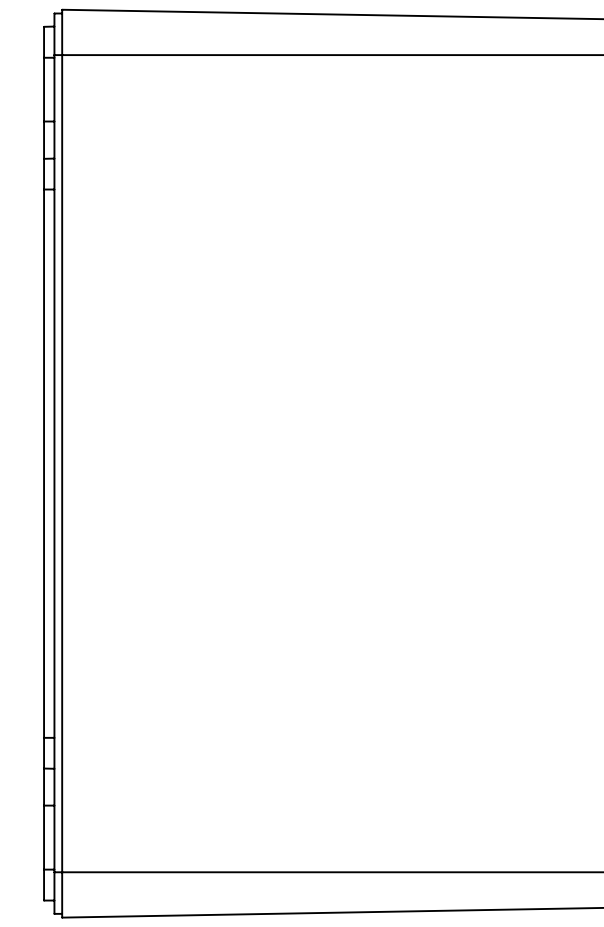

SURFACE-4

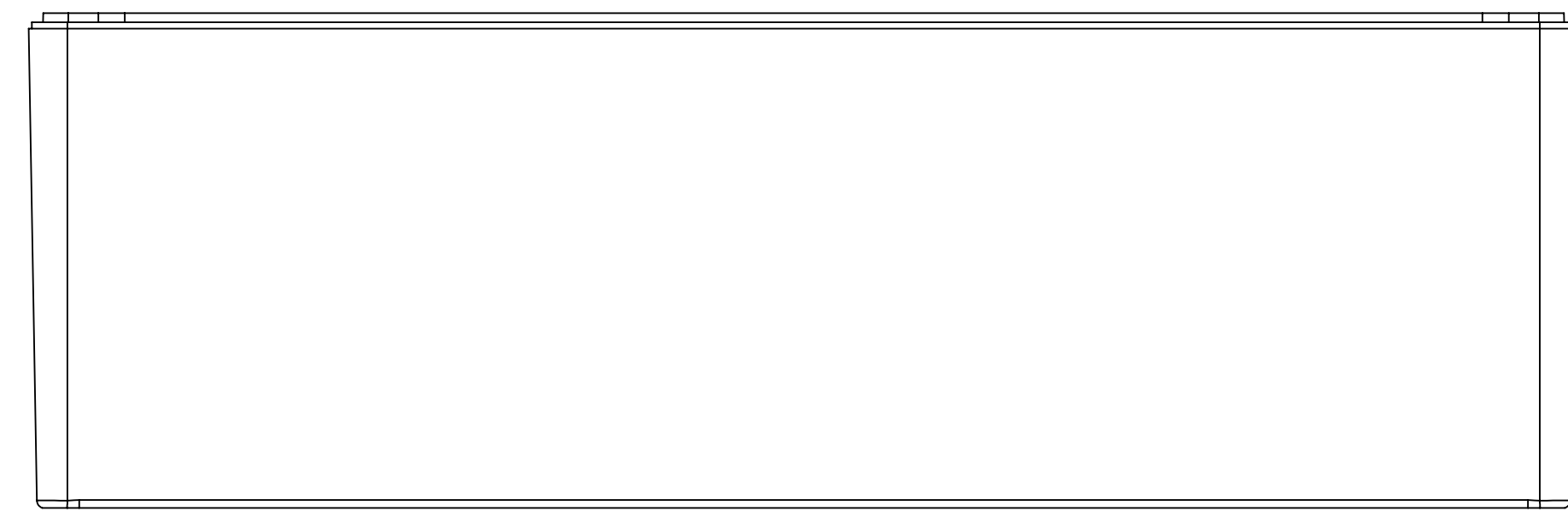

SURFACE-2

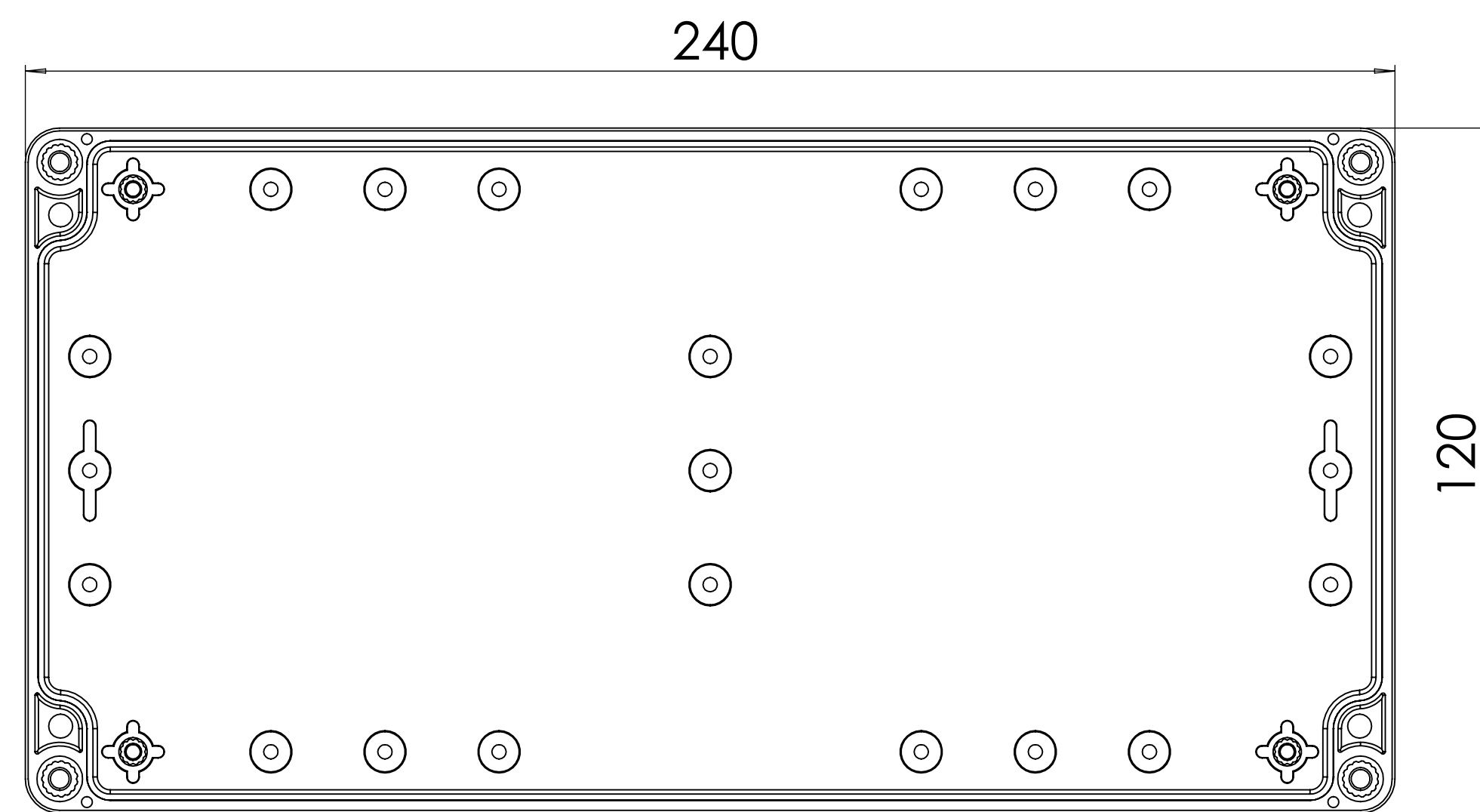
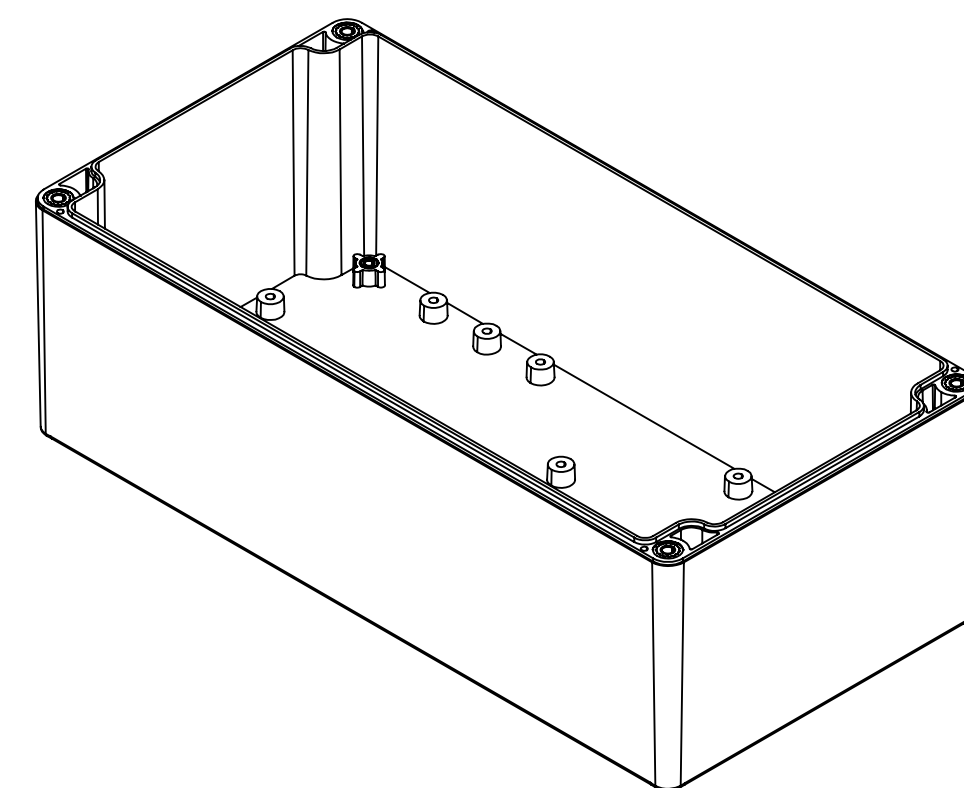

SURFACE-6 (INSIDE)

COVER: 6 SURFACE

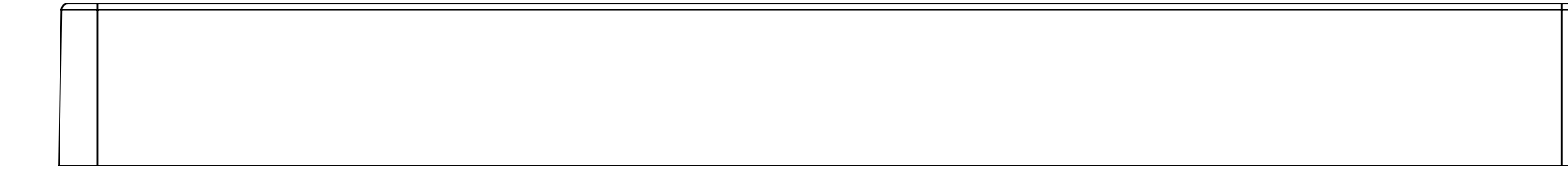

SURFACE-7

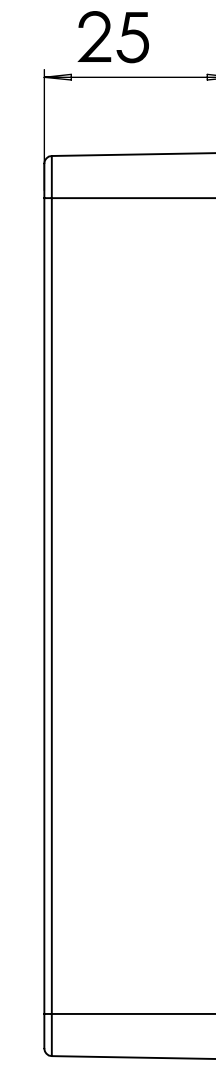

SURFACE-9

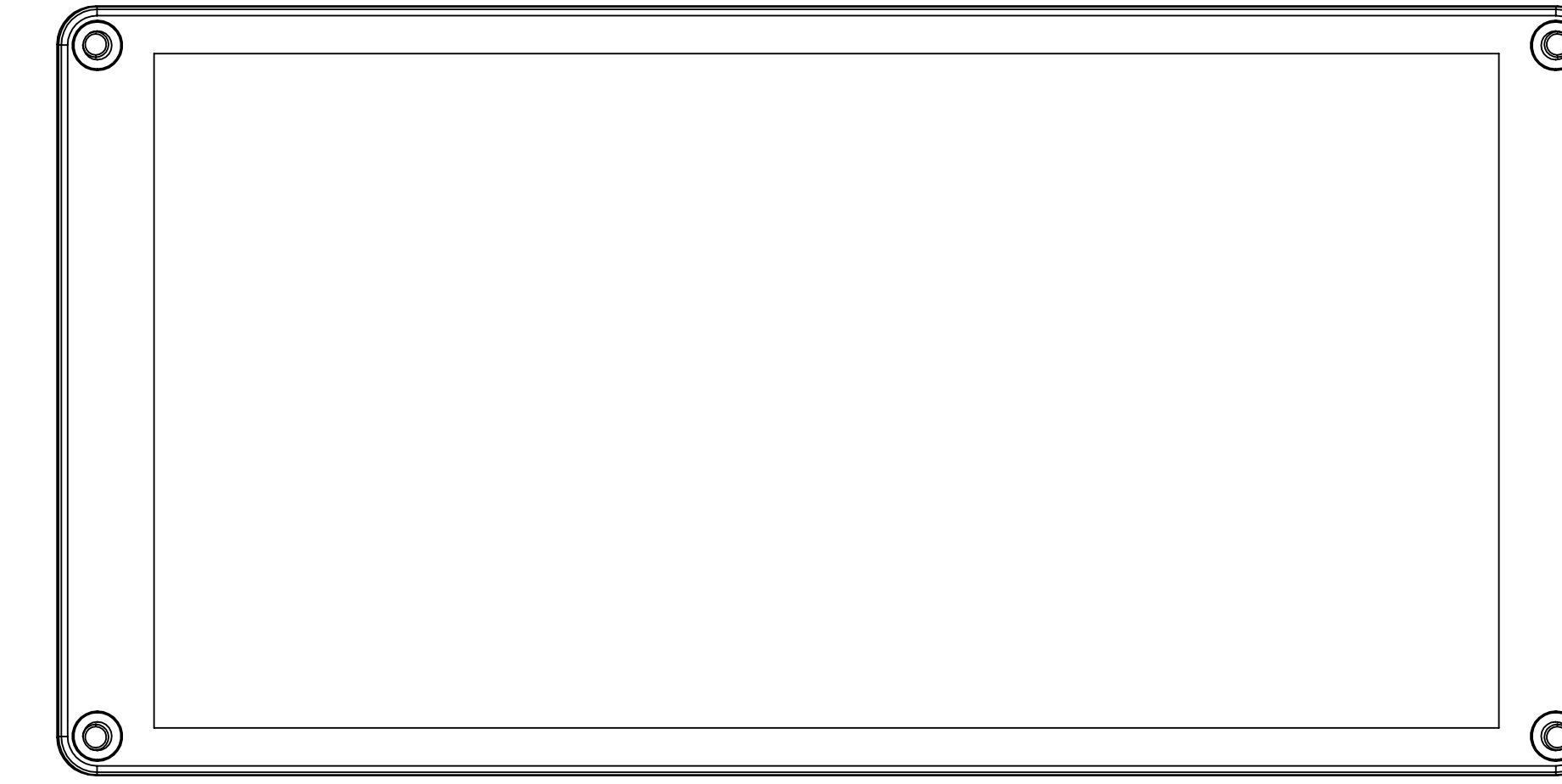

SURFACE-11

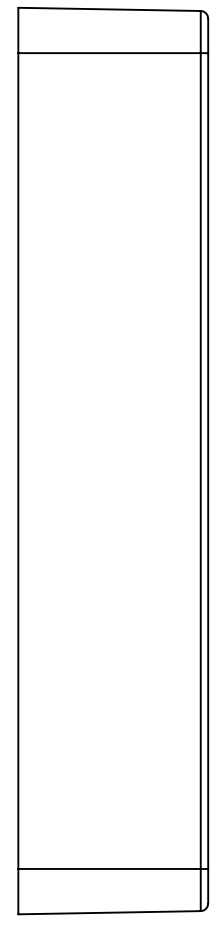

SURFACE-10

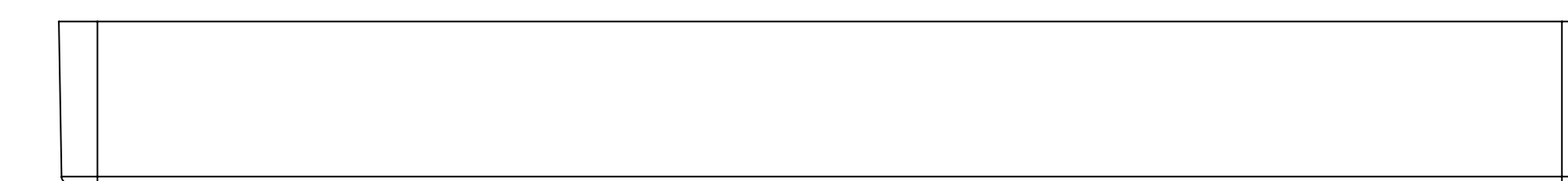

SURFACE-8

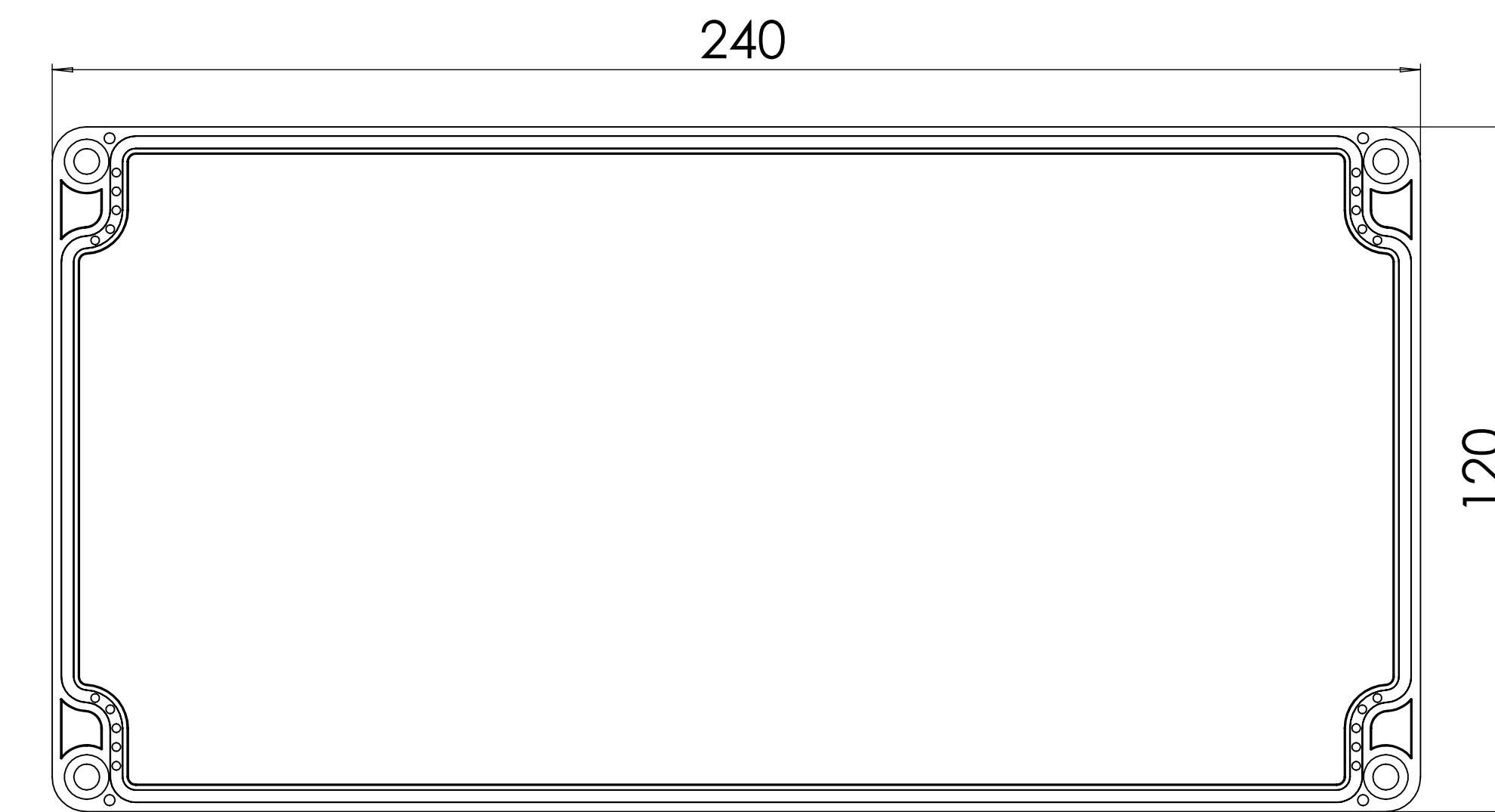
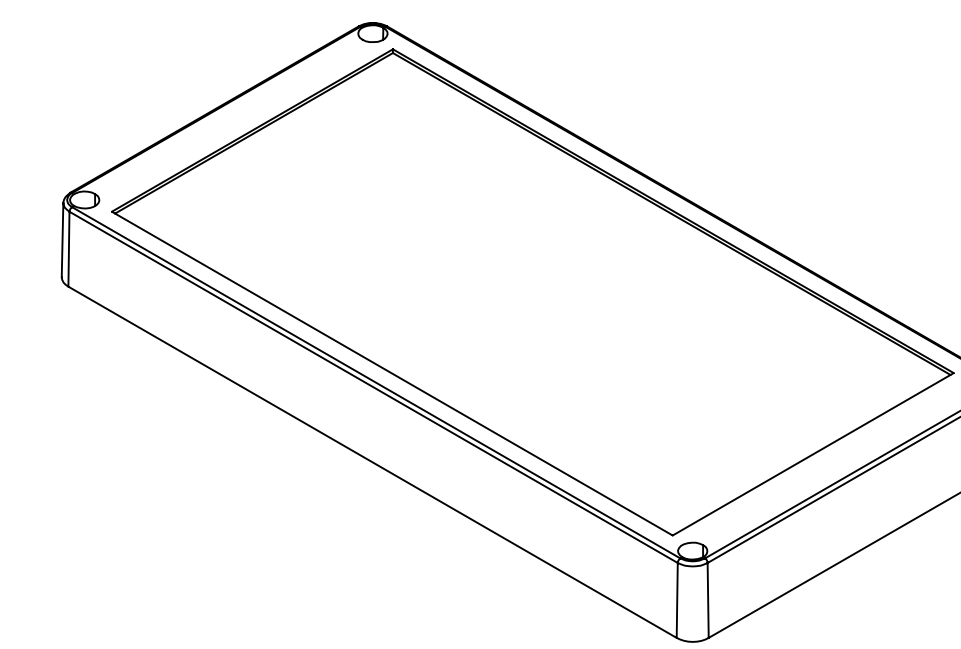

SURFACE-12 (INSIDE)

REV. NO	DATE	REVISED BY	DESCRIPTION OF CHANGE			
 ALTINKAYA Electronic Enclosures & Components			www.altinkaya.com			
Customer Name:		Customer Ref.:				
Altinkaya Ref.:		Part Name: SE-250-0-0				
DRAWN	NAME	DATE	Drawn From:		SCALE 1:1	
CHECKED	Y.YEL	14.06.2024	Material:		SHEET 1 OF 2	
DIMENSIONAL TOLERANCES UNLESS OTHERWISE SPECIFIED (DIN7168)			0.5-3mm	3-6mm	6-30mm	
			±0.1	±0.1	±0.2	
			±0.3	±0.5	±0.5	
			Dimension (mm)			
			m (Medium)			
			UNIT: mm			

