

BASE: 6 SURFACE

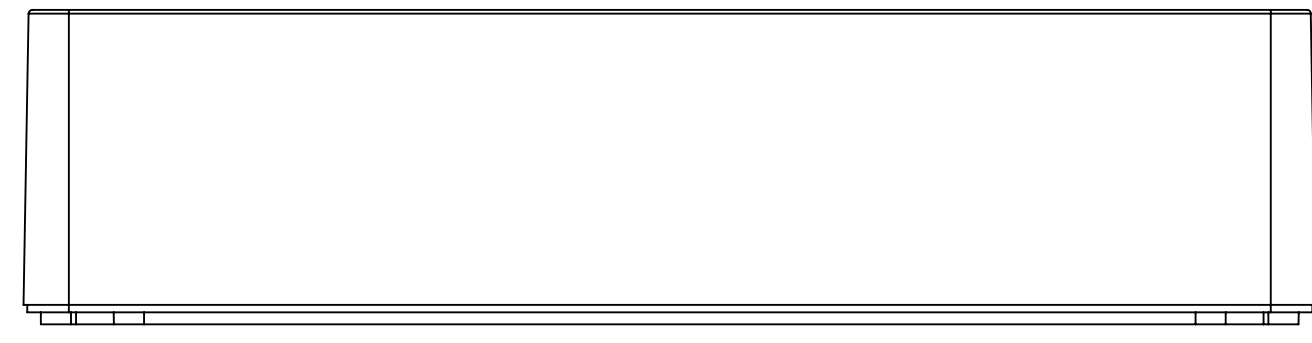

SURFACE-1

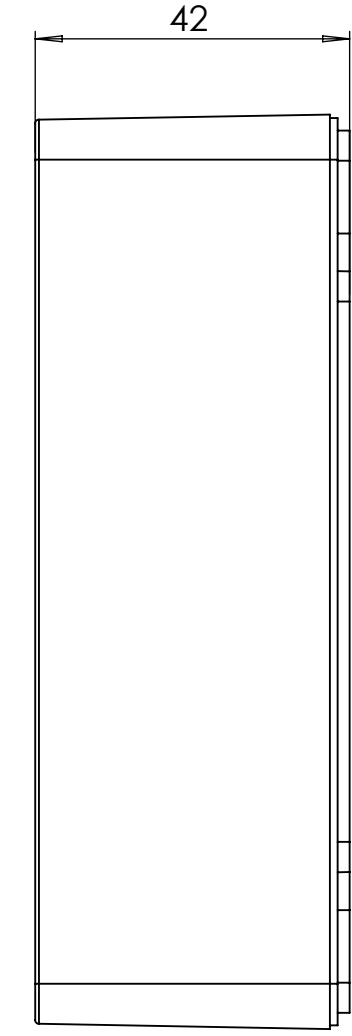

SURFACE-3



SURFACE-5

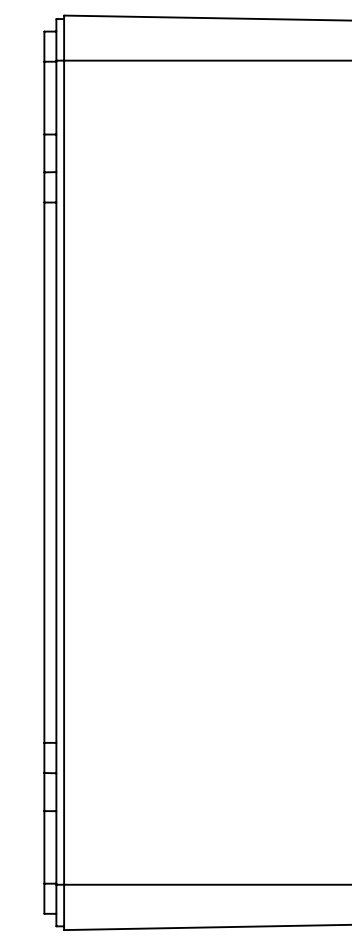

SURFACE-4

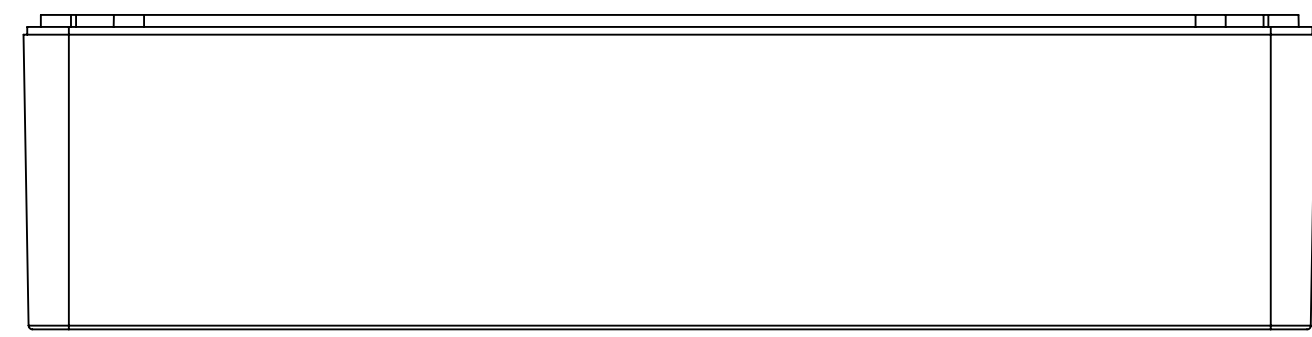

SURFACE-2

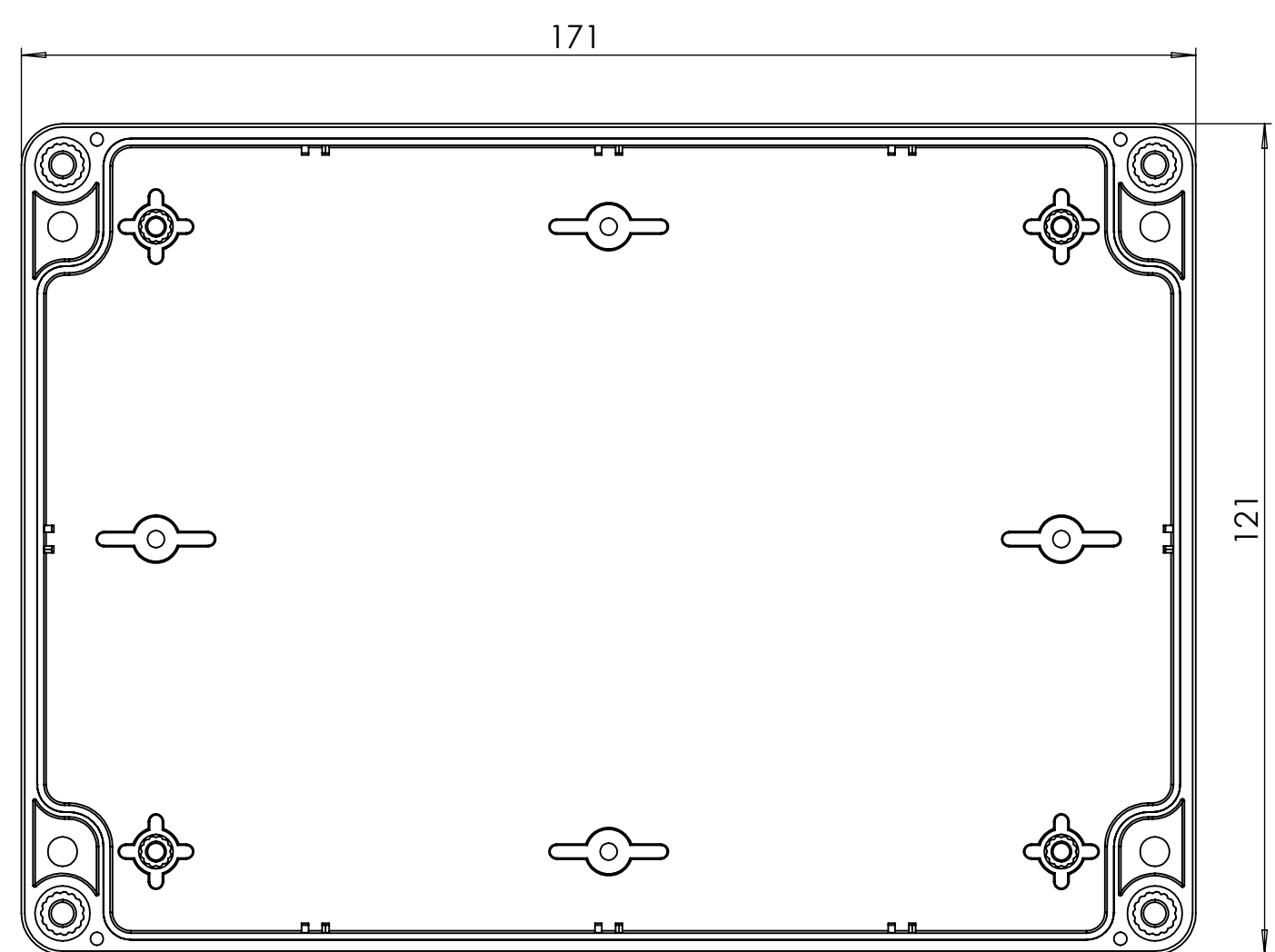

SURFACE-6 (INSIDE)

COVER: 6 SURFACE

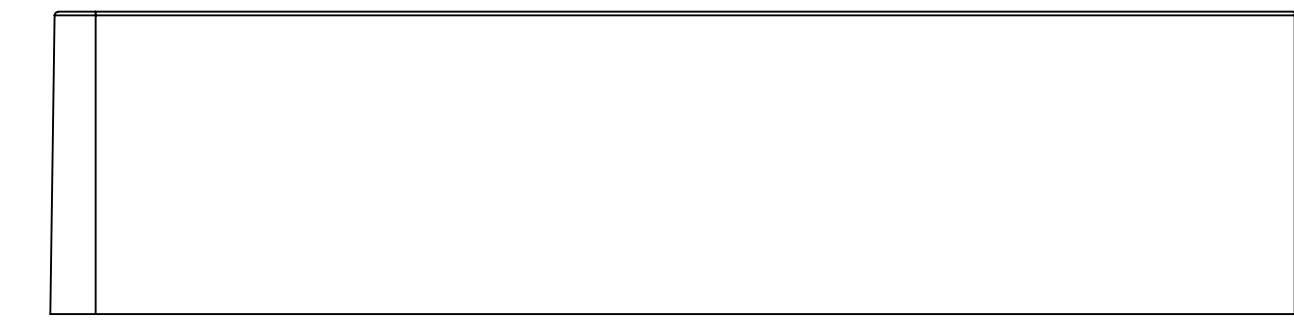

SURFACE-7

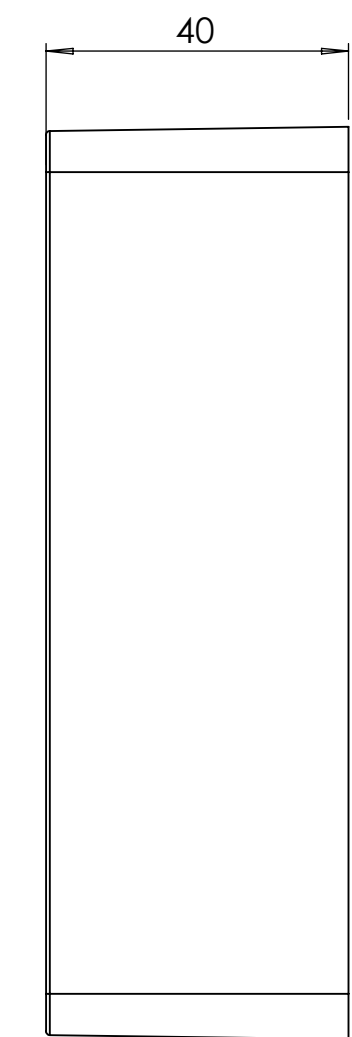

SURFACE-9



SURFACE-11

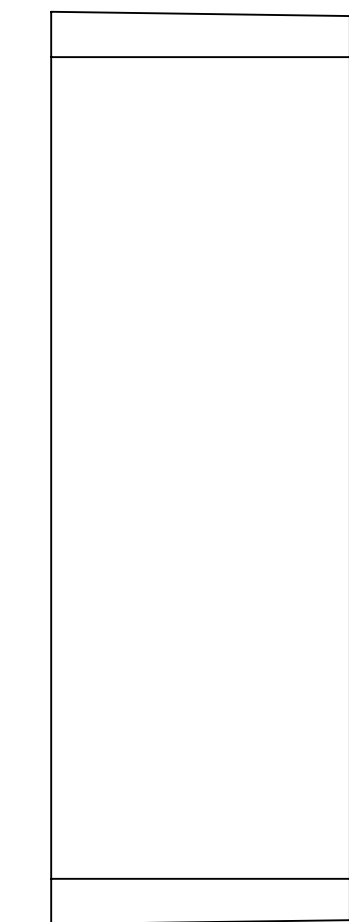

SURFACE-10

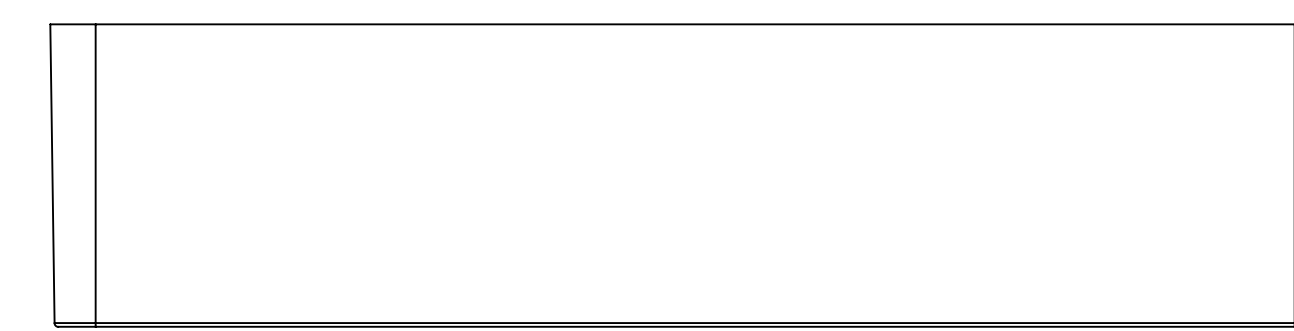

SURFACE-8

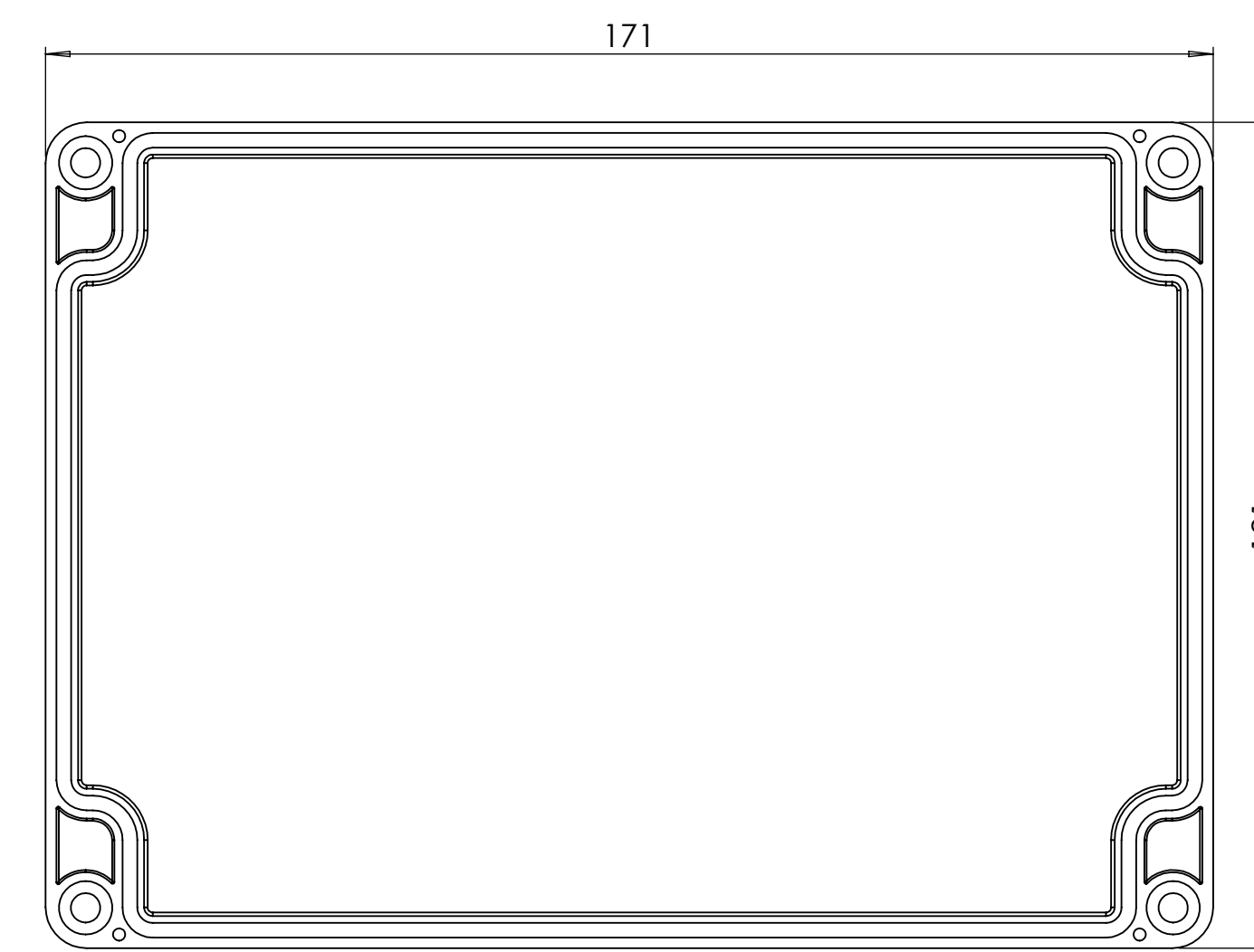

SURFACE-12 (INSIDE)

REV. NO	DATE	REVISED BY	DESCRIPTION OF CHANGE
 ALTINKAYA Electronic Enclosures & Components			www.altinkaya.com
Customer Name:		Customer Ref.:	
Altinkaya Ref.:		Part Name: SE-238-0-0	
DRAWN	NAME	DATE	Drawn From:
	S.YESILOZ	12.06.2024	Material:
CHECKED	Y.YEL	12.06.2024	Weight:
DIMENSIONAL TOLERANCES UNLESS OTHERWISE SPECIFIED (DIN7168)			
	0.5-3mm	3-6mm	6-30mm
	±0.1	±0.1	±0.2
			±0.3
			±0.5
			m (Medium)
SCALE 1:1			SHEET 1 OF 2
UNIT: mm			A0

SE-238 IF MACHINED TOGETHER



SURFACE-13

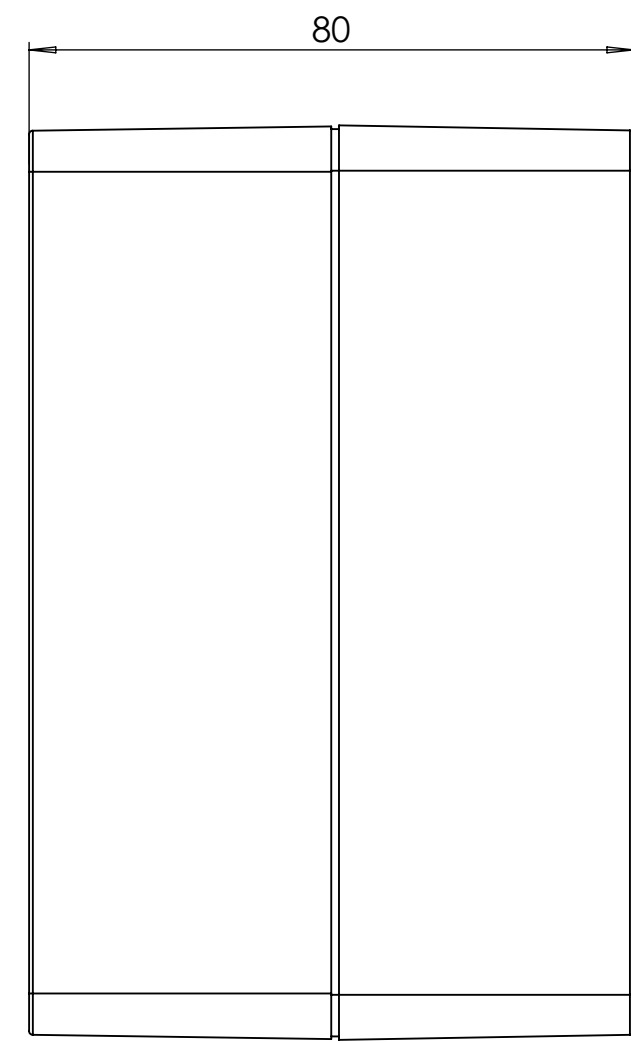

SURFACE-15



SURFACE-17

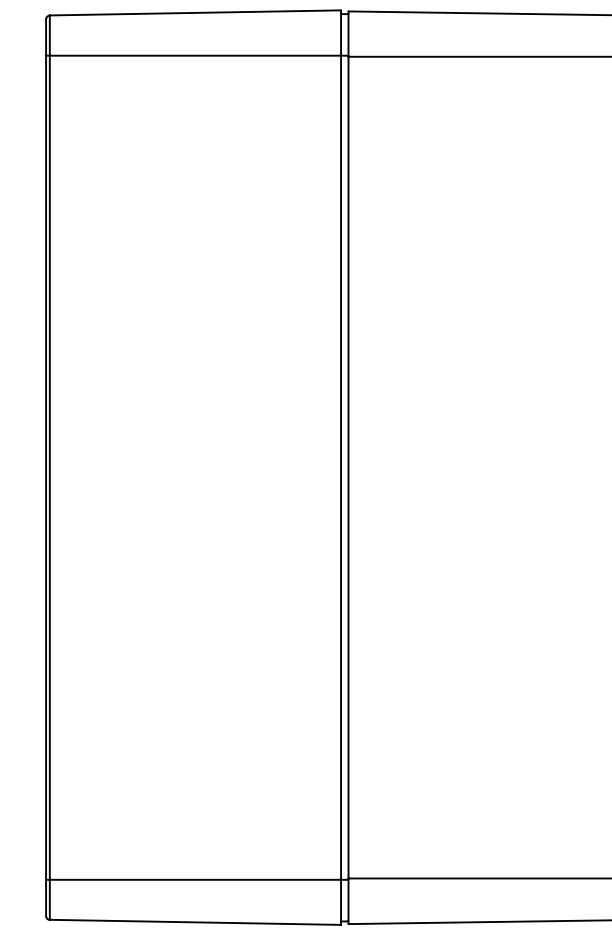

SURFACE-16

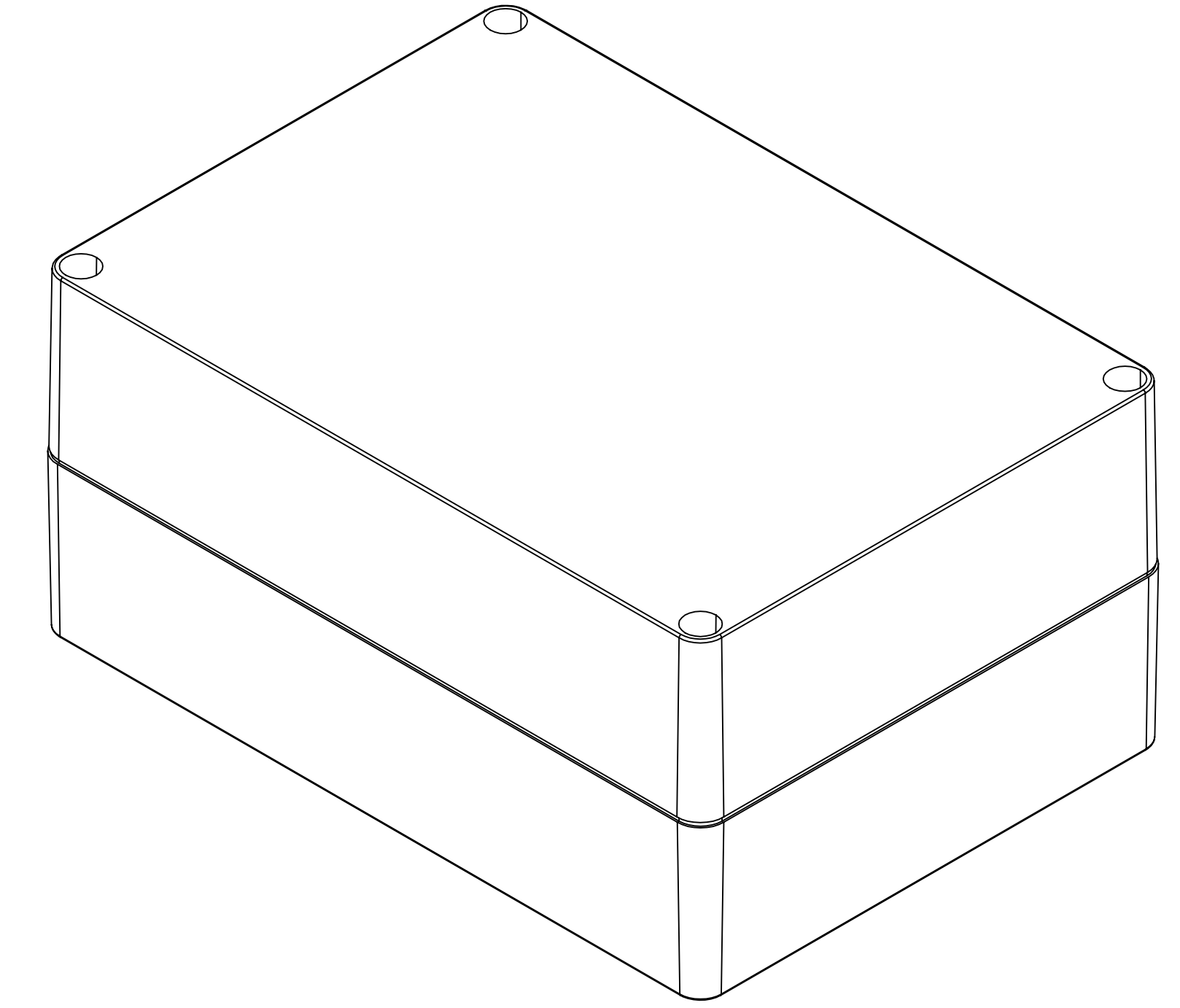

SURFACE-14

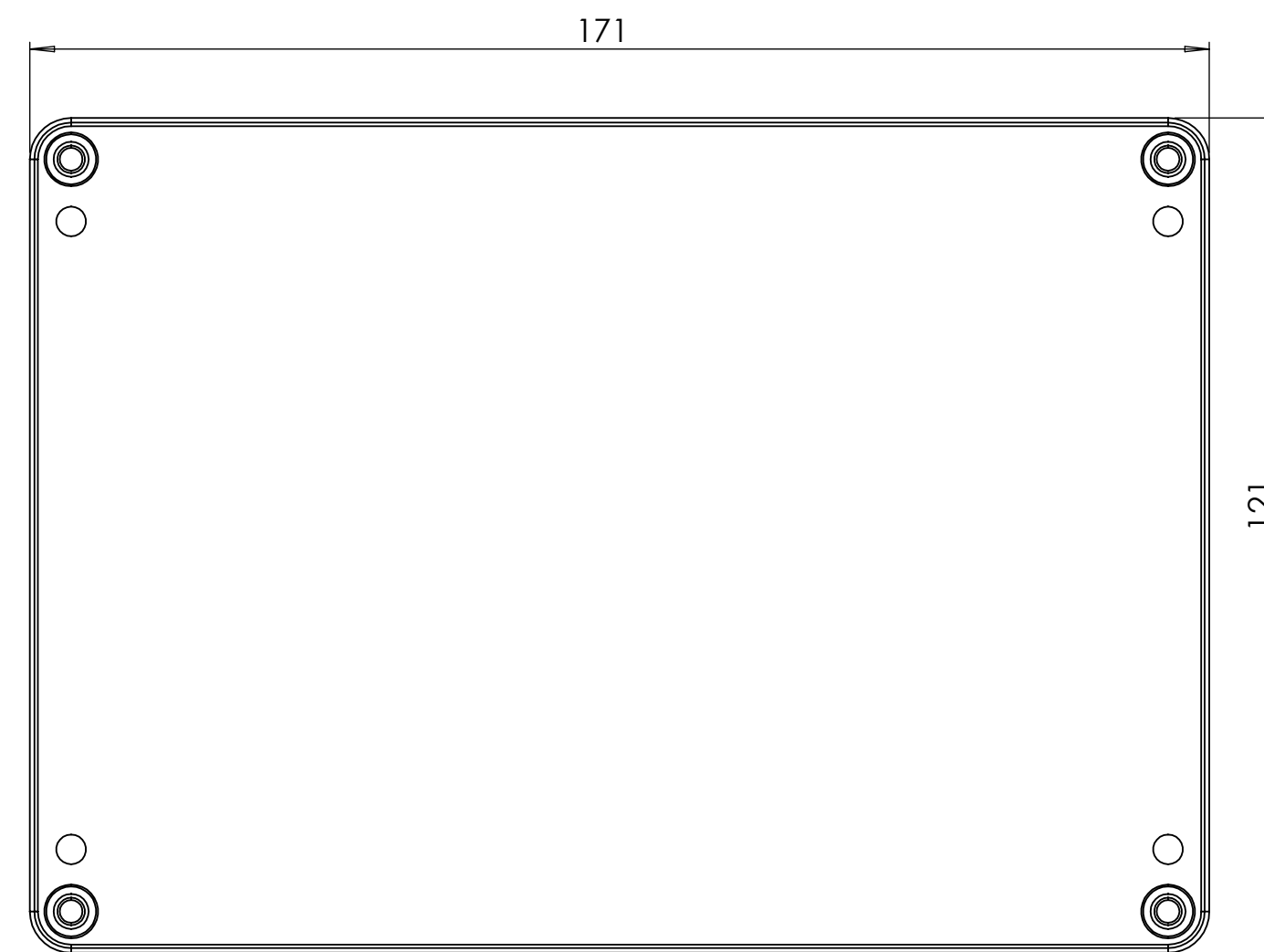
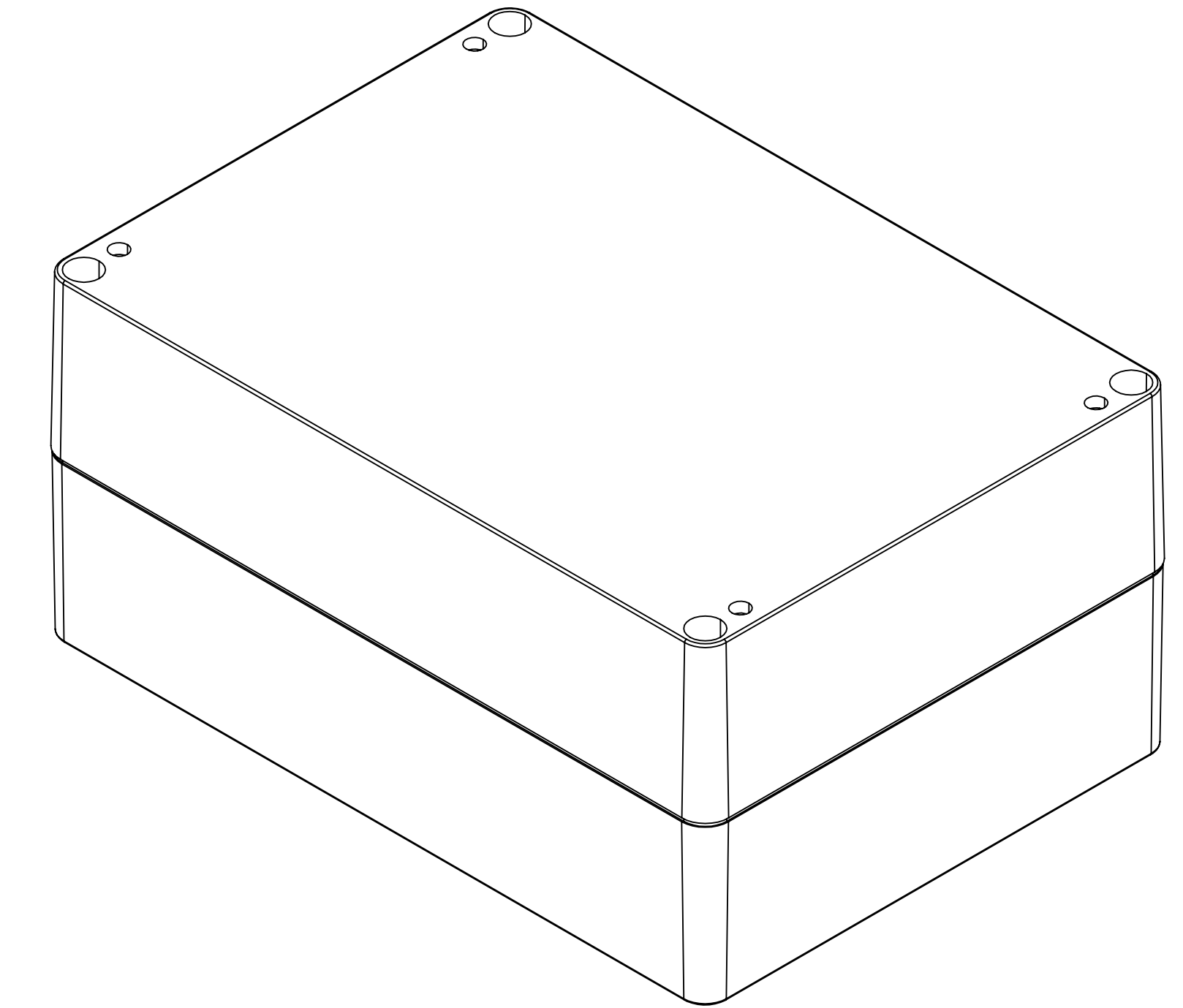

SURFACE-18

REV. NO	DATE	REVISED BY	DESCRIPTION OF CHANGE
 ALTINKAYA Electronic Enclosures & Components			www.altinkaya.com
Customer Name:		Customer Ref.:	
Altinkaya Ref.:		Part Name: SE-238-0-0	
DRAWN	NAME	DATE	Drawn From:
CHECKED	Y.YEL	12.06.2024	Weight:
DIMENSIONAL TOLERANCES UNLESS OTHERWISE SPECIFIED (DIN7168)			
0.5-3mm	3-6mm	6-30mm	30-120mm
±0.1	±0.1	±0.2	±0.3
			120-400mm
			±0.5
			m (Medium)
			SCALE 1:1
			SHEET 2 OF 2
			UNIT: mm
			A0