

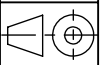

	NAME	DATE	ARTICLE NO:	REVISION:	TITLE:	
DRAWN	Dursun Dağdemir				DE-060 Profil	
CHECKED	Ali Altınışık					
 <b>ALTINKAYA</b> ENCLOSURES FOR ELECTRONICS <a href="http://www.altinkaya.com.tr">www.altinkaya.com.tr</a>			COMMENTS: DIMENSIONS ARE IN MILLIMETERS, DEBUR AND BREAK SHARP EDGES		DWG NO.	A4
PROPRIETARY AND CONFIDENTIAL THE INFORMATION CONTAINED IN THIS DRAWING IS THE SOLE PROPERTY OF ALTINKAYA ENCLOSURES. ANY REPRODUCTION IN PART OR AS A WHOLE WITHOUT THE WRITTEN PERMISSION OF ALTINKAYA ENCLOSURES IS PROHIBITED.			MATERIAL:		WEIGHT:	SCALE:
					SHEET OF	

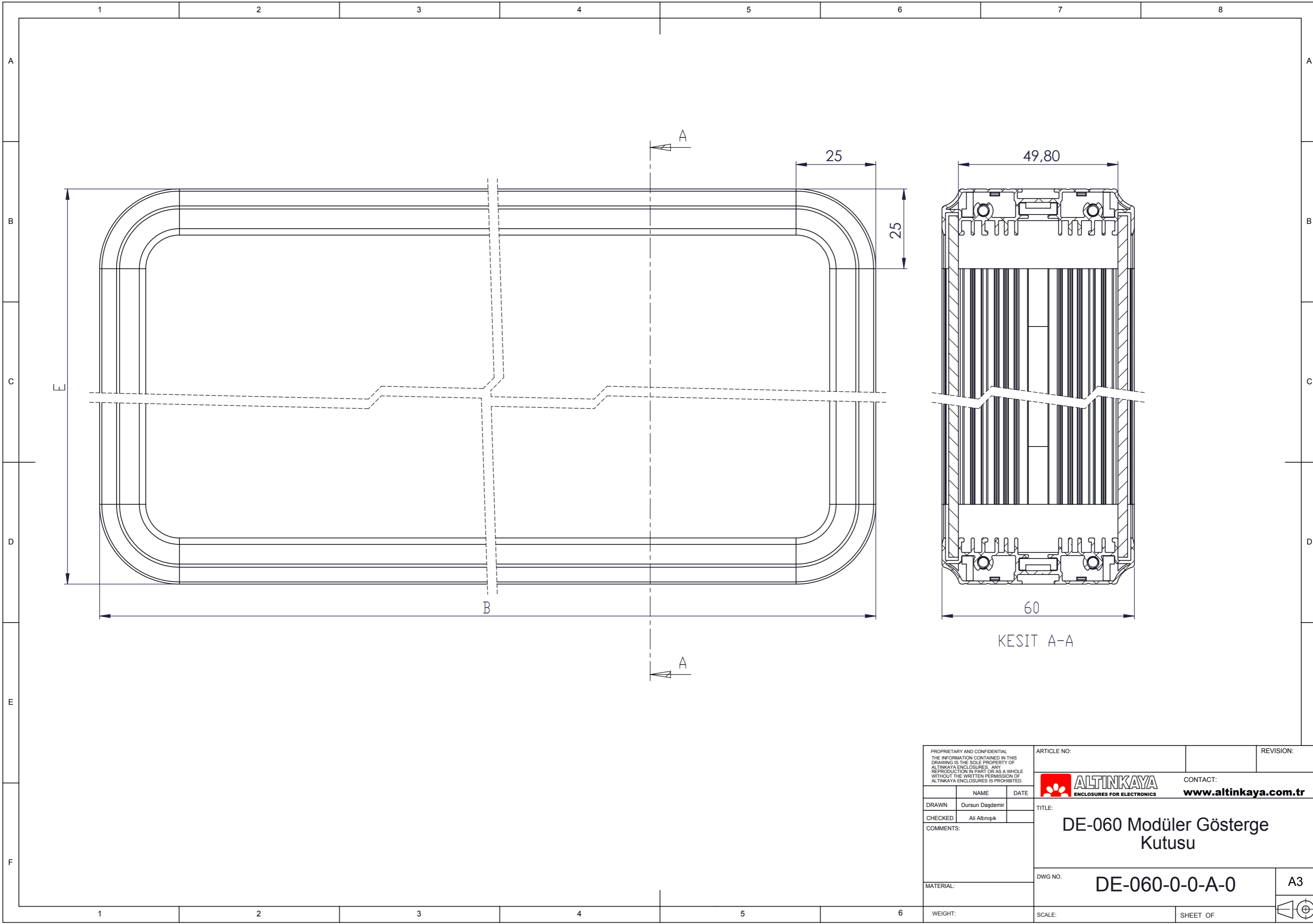





<small>PROPRIETARY AND CONFIDENTIAL THE INFORMATION CONTAINED IN THIS DRAWING IS THE SOLE PROPERTY OF ALTINKAYA ENCLOSURES. ANY REPRODUCTION IN PART OR AS A WHOLE WITHOUT THE WRITTEN PERMISSION OF ALTINKAYA ENCLOSURES IS PROHIBITED.</small>		ARTICLE NO:	REVISION:
<small>DRAWN</small> Dursun Daşdemir		 <small>ENCLOSURES FOR ELECTRONICS</small>	<small>CONTACT:</small> <a href="http://www.altinkaya.com.tr">www.altinkaya.com.tr</a>
<small>CHECKED</small> Ali Altınışık		<small>TITLE:</small> <b>DE-060 Modüler Gösterge Kutusu</b>	
<small>COMMENTS:</small>		<small>DWG NO.</small> <b>DE-060-0-0-A-0</b>	<small>A3</small>
<small>MATERIAL:</small>		<small>SCALE:</small>	<small>SHEET OF</small>
<small>WEIGHT:</small>			

PCB Sample

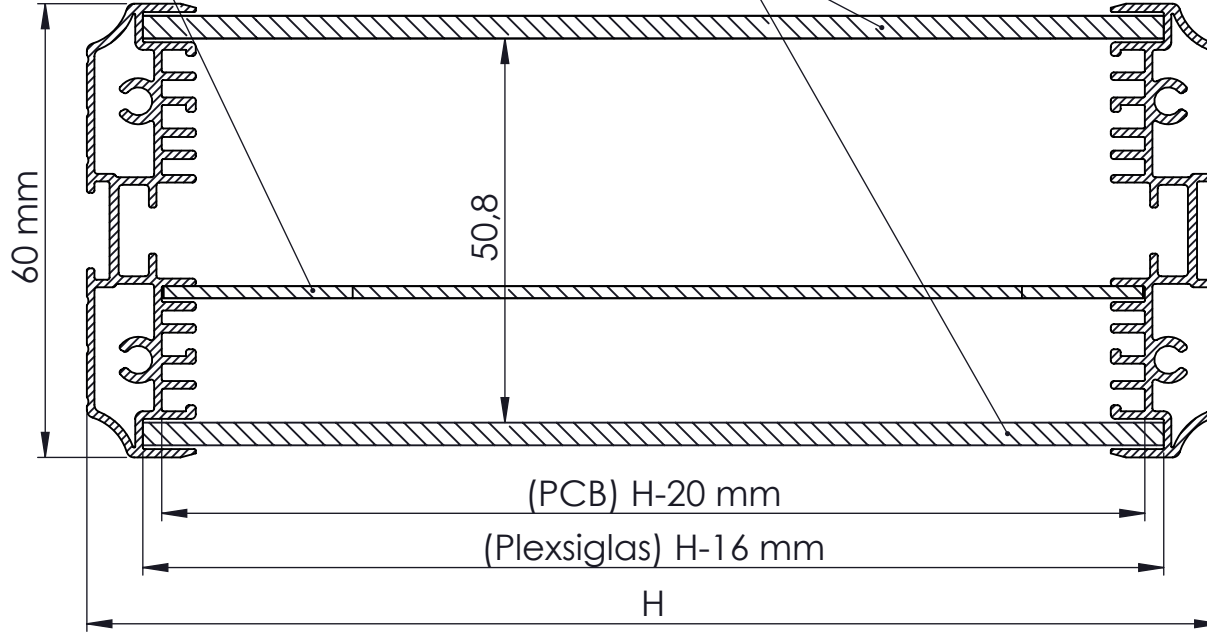
Plexiglas



	NAME	DATE	ARTICLE NO:	REVISION:	TITLE:
DRAWN	Dursun Dağdemir				
CHECKED	Ali Altınışık				
 <b>ALTINKAYA</b> ENCLOSURES FOR ELECTRONICS <a href="http://www.altinkaya.com.tr">www.altinkaya.com.tr</a>			COMMENTS: This drawing is subject to technical modification without prior notice. Typographical and other errors do not justify any claims for damages. All dimensions should be verified using an actual produced part.		
PROPRIETARY AND CONFIDENTIAL THE INFORMATION CONTAINED IN THIS DRAWING IS THE SOLE PROPERTY OF ALTINKAYA ENCLOSURES. ANY REPRODUCTION IN PART OR AS A WHOLE WITHOUT THE WRITTEN PERMISSION OF ALTINKAYA ENCLOSURES IS PROHIBITED.			DİKKAT: BU RESİM VE ÜRÜN ÖNCEDEN HABER VERİLMEKSİZİN DEĞİŞTİREBİLİR. RESİM ÇİZİLİRKEN HATASIZ OLMASINA ÇALIŞILMASINA RAĞMEN RESİMDE HATALAR BULUNABİLİR. RESİMDEKİ HATALARDAN DOLAYI OLUŞABİLECEK ZARARLAR İÇİN ALTINKAYA HİÇ BİR SORUMLULUK KABUL ETMEZ. BÜTÜN ÖLÇÜLER KULLANILMADAN ÖNCE ÜRETİLMİŞ GERÇEK NUMUNEDEN KONTROL EDİLMELİDİR.		DWG NO.
MATERIAL:			WEIGHT:	SCALE:	SHEET OF

A4



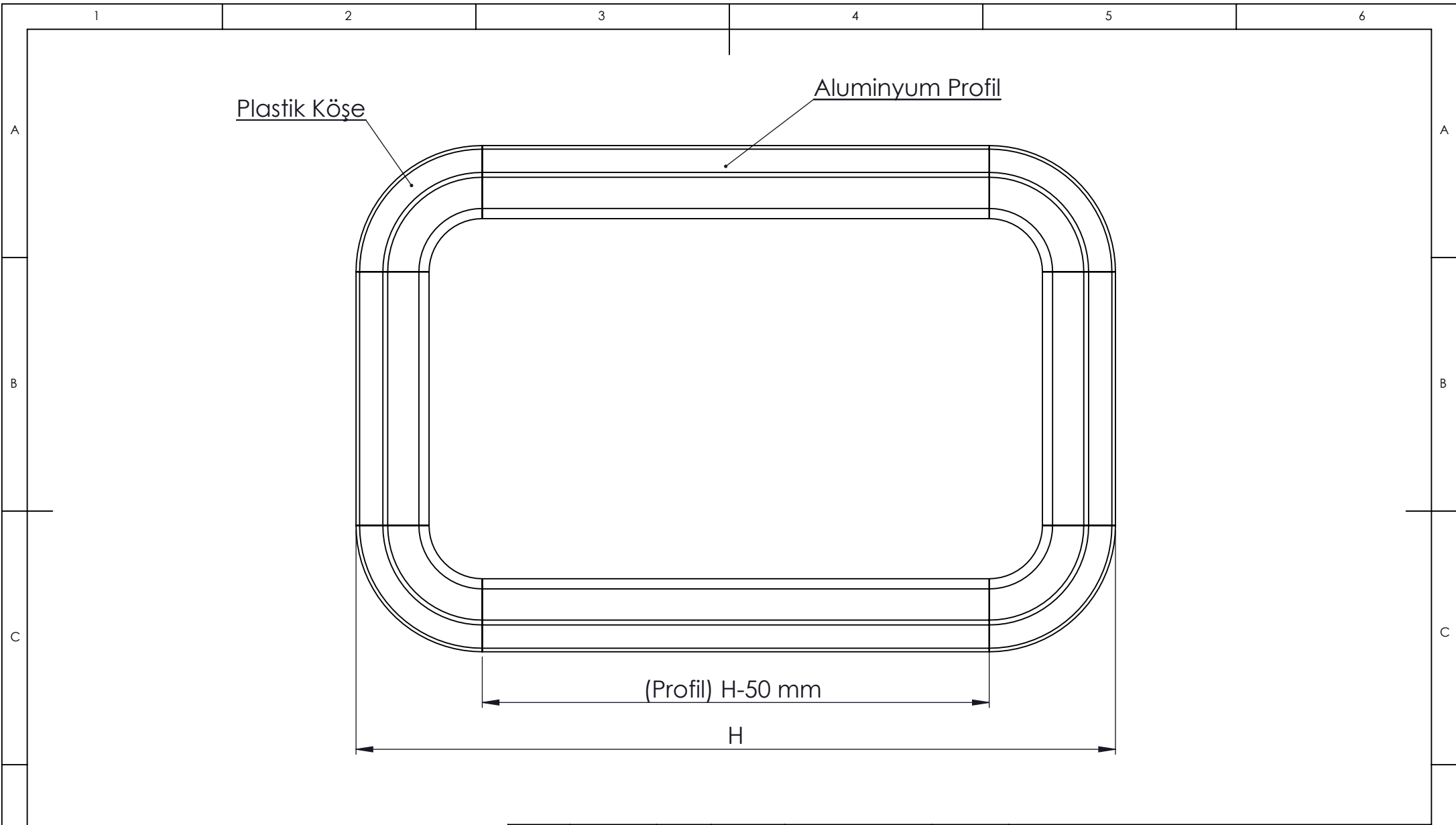



	NAME	DATE	ARTICLE NO:	REVISION:	TITLE:
DRAWN	Dursun Dağdemir				
CHECKED	Ali Altınışık		COMMENTS:		
 <b>www.altinkaya.com.tr</b>			DİKKAT: BU RESİM VE ÜRÜN ÖNCEDEN HABER VERİLMEKSİZİN DEĞİŞTİRİLEBİLİR. RESİM ÖZİLİRKEN HATASIZ OLMASINA ÇALIŞILMASINA RAĞMEN RESİMDE HATALAR BULUNABİLİR. RESİMDEKİ HATALARDAN DOLAYI OLUŞABİLECEK ZARARLAR İÇİN ALTINKAYA HiÇ BİR SORUMLULUK KABUL ETMEZ. BÜTÜN ÖLÇÜLER KULLANILMADAN ÖNCE ÜRETİLMİŞ GERÇEK NUMUNEDEN KONTROL EDİLMELİDİR.		DWG NO.
PROPRIETARY AND CONFIDENTIAL THE INFORMATION CONTAINED IN THIS DRAWING IS THE SOLE PROPERTY OF ALTINKAYA ENCLOSURES. ANY REPRODUCTION IN PART OR AS A WHOLE WITHOUT THE WRITTEN PERMISSION OF ALTINKAYA ENCLOSURES IS PROHIBITED.			MATERIAL:	WEIGHT:	SCALE:
					SHEET OF

A4

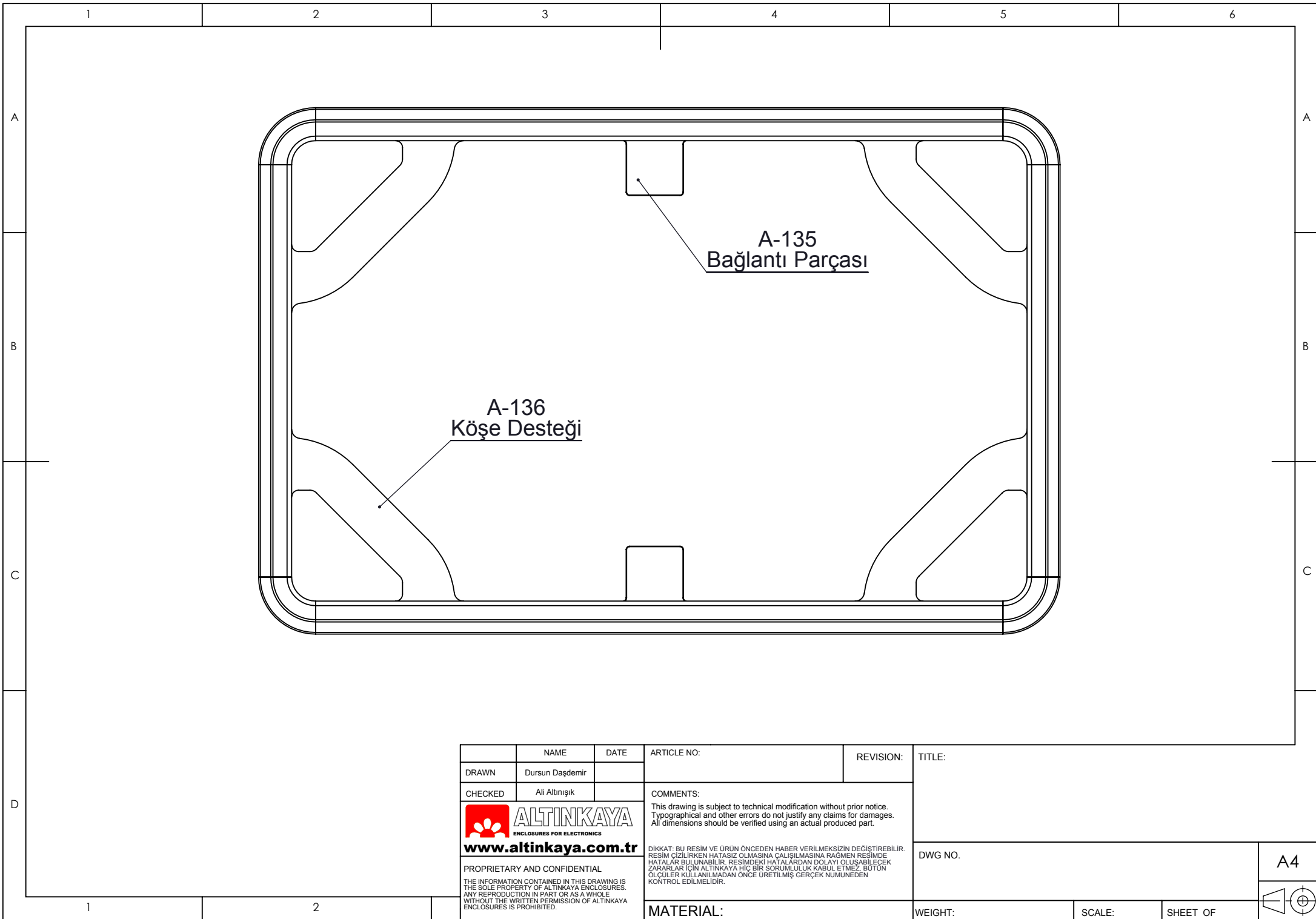



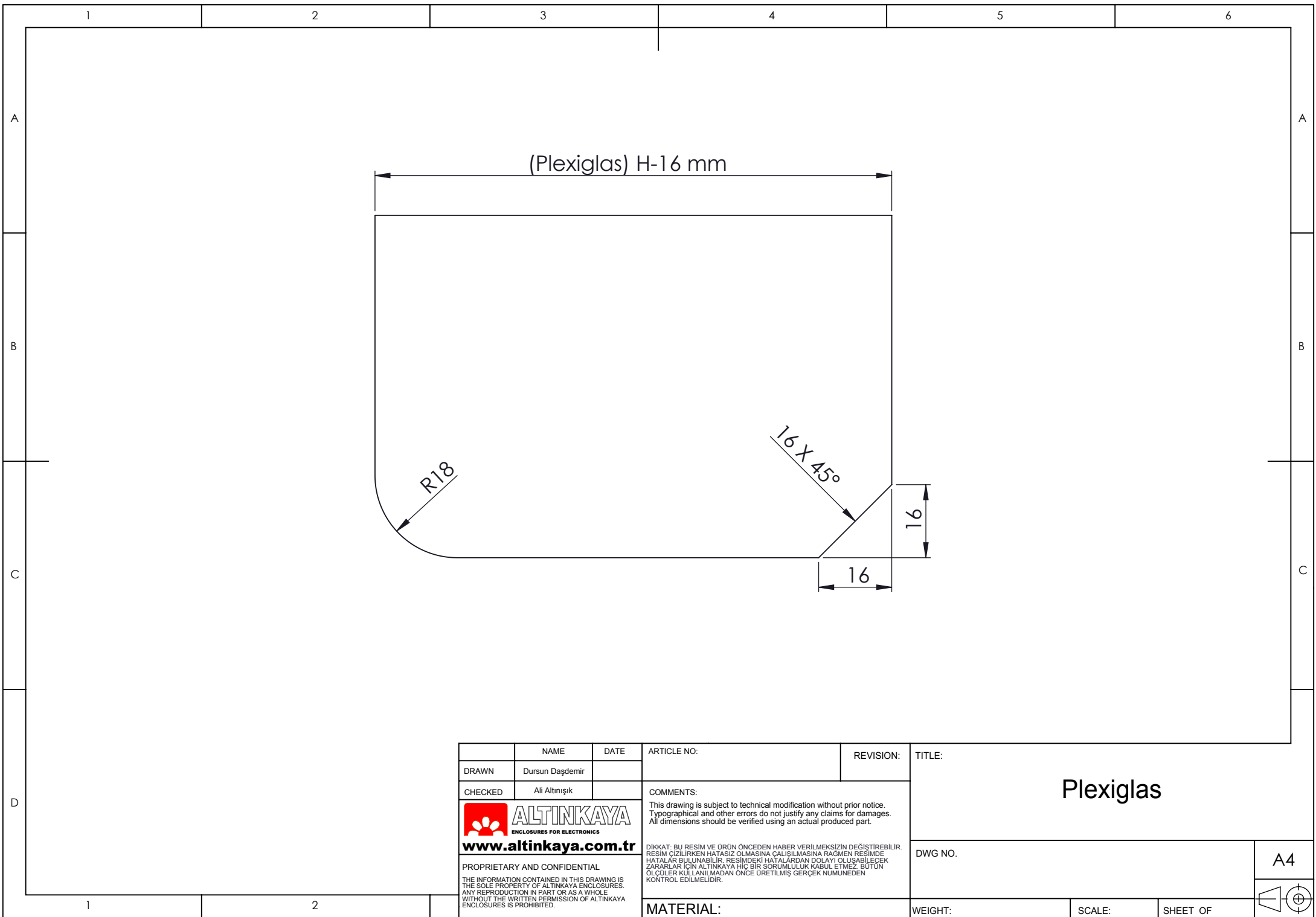

	NAME	DATE	ARTICLE NO:	REVISION:	TITLE:	
DRAWN	Dursun Daşdemir					
CHECKED	Ali Altınışık		COMMENTS:			
 <b>www.altinkaya.com.tr</b>			DİKKAT: BU RESİM VE ÜRÜN ÖNCEDEN HABER VERİLMEKSİZİN DEĞİŞTİRİLEBİLİR. RESİM ÖZİLLERİN HATASIZ OLMASINA ÇALIŞILMASINA RAĞMEN RESİMDE HATALAR BULUNABİLİR. RESİMDEKİ HATALARDAN DOLAYI OLUŞABİLECEK ZARARLAR İÇİN ALTINKAYA HİÇ BİR SORUMLULUK KABUL ETMEZ. BUTÜN ÖLÇÜLER KULLANILMADAN ÖNCE ÜRETİLMİŞ GERÇEK NUMUNEDEN KONTROL EDİLMELİDİR.		DWG NO.	A4
PROPRIETARY AND CONFIDENTIAL THE INFORMATION CONTAINED IN THIS DRAWING IS THE SOLE PROPERTY OF ALTINKAYA ENCLOSURES. ANY REPRODUCTION IN PART OR AS A WHOLE WITHOUT THE WRITTEN PERMISSION OF ALTINKAYA ENCLOSURES IS PROHIBITED.			MATERIAL:	WEIGHT:	SCALE:	
			SHEET OF			

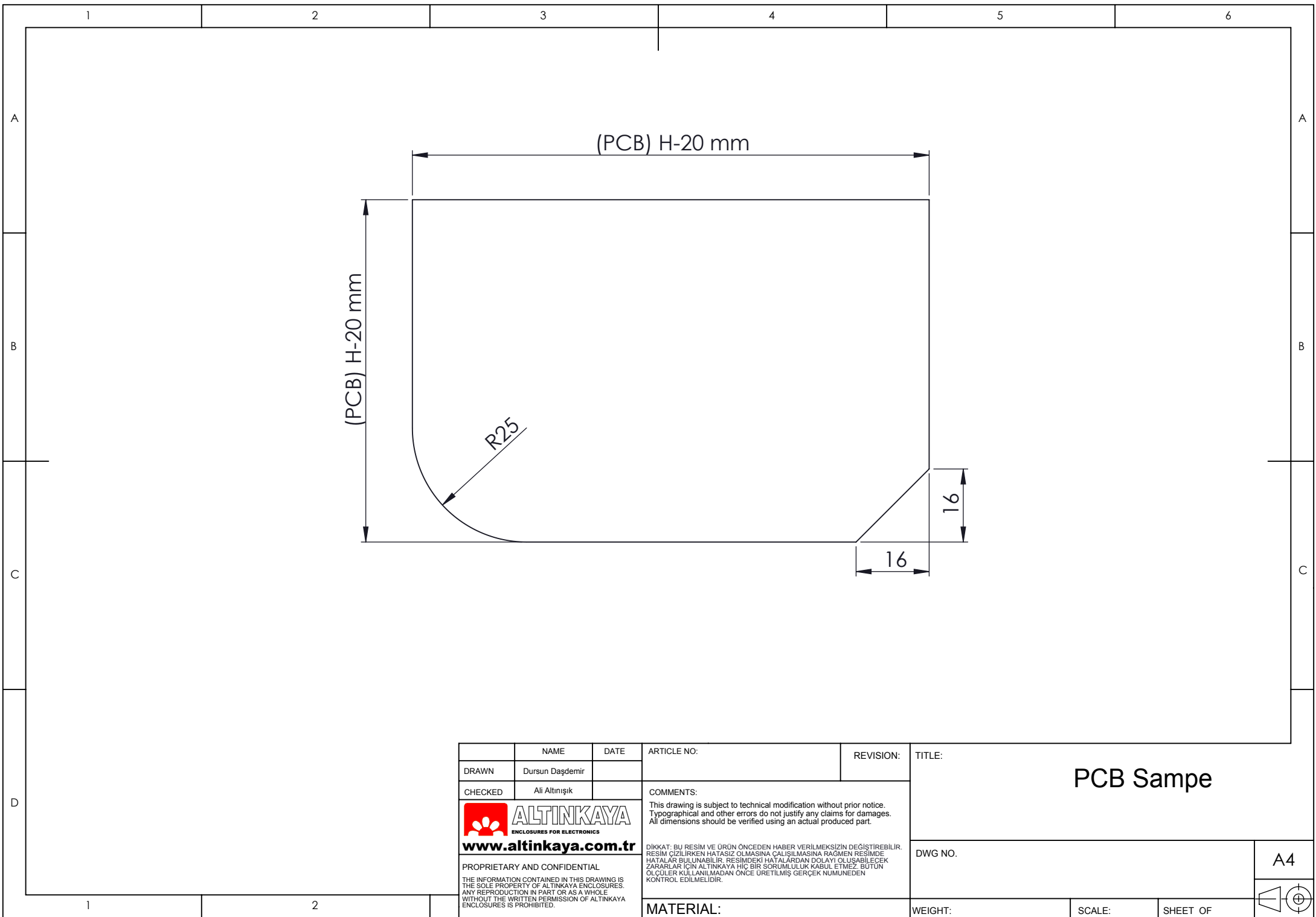

	NAME	DATE	ARTICLE NO:	REVISION:	TITLE:
DRAWN	Dursun Dağdemir				<h1>Plexiglas</h1>
CHECKED	Ali Altınışık				
 <b>www.altinkaya.com.tr</b>			COMMENTS:		DWG NO.
			This drawing is subject to technical modification without prior notice. Typographical and other errors do not justify any claims for damages. All dimensions should be verified using an actual produced part.		
PROPRIETARY AND CONFIDENTIAL THE INFORMATION CONTAINED IN THIS DRAWING IS THE SOLE PROPERTY OF ALTINKAYA ENCLOSURES. ANY REPRODUCTION IN PART OR AS A WHOLE WITHOUT THE WRITTEN PERMISSION OF ALTINKAYA ENCLOSURES IS PROHIBITED.			DİKKAT: BU RESİM VE ÜRÜN ÖNCEDEN HABER VERİLMEKSİZİN DEĞİŞTİRİLEBİLİR. RESİM ÖZİLLİRKEN HATASIZ OLMASINA ÇALIŞILMASINA RAĞMEN RESİMDE HATALAR BULUNABİLİR. RESİMDEKİ HATALARDAN DOLAYI OLUŞABİLECEK ZARARLAR İÇİN ALTINKAYA HiÇ BİR SORUMLULUK KABUL ETMEZ. BÜTÜN ÖLÇÜLER KULLANILMADAN ÖNCE ÜRETİLMİŞ GERÇEK NUMUNEDEN KONTROL EDİLMELİDİR.		A4
MATERIAL:			WEIGHT:	SCALE:	SHEET OF



	NAME	DATE	ARTICLE NO:	REVISION:	TITLE:
DRAWN	Dursun Daşdemir				PCB Sampe
CHECKED	Ali Altınışık				
 <b>www.altinkaya.com.tr</b>			COMMENTS: This drawing is subject to technical modification without prior notice. Typographical and other errors do not justify any claims for damages. All dimensions should be verified using an actual produced part.		DWG NO.
PROPRIETARY AND CONFIDENTIAL THE INFORMATION CONTAINED IN THIS DRAWING IS THE SOLE PROPERTY OF ALTINKAYA ENCLOSURES. ANY REPRODUCTION IN PART OR AS A WHOLE WITHOUT THE WRITTEN PERMISSION OF ALTINKAYA ENCLOSURES IS PROHIBITED.			DİKKAT: BU RESİM VE ÜRÜN ÖNCEDEN HABER VERİLMEKSİZİN DEĞİŞTİRİLEBİLİR. RESİM ÇİZİLİRKEN HATASIZ OLMASINA ÇALIŞILMASINA RAĞMEN RESİMDE HATALAR BULUNABİLİR. RESİMDEKİ HATALARDAN DOLAYI OLUŞABİLECEK ZARARLAR İÇİN ALTINKAYA HiÇ BİR SORUMLULUK KABUL ETMEZ. BÜTÜN ÖLÇÜLER KULLANILMADAN ÖNCE ÜRETİLMİŞ GERÇEK NUMUNEDEN KONTROL EDİLMELİDİR.		
MATERIAL:			WEIGHT:		SCALE:
					SHEET OF

