

KESIT A-A

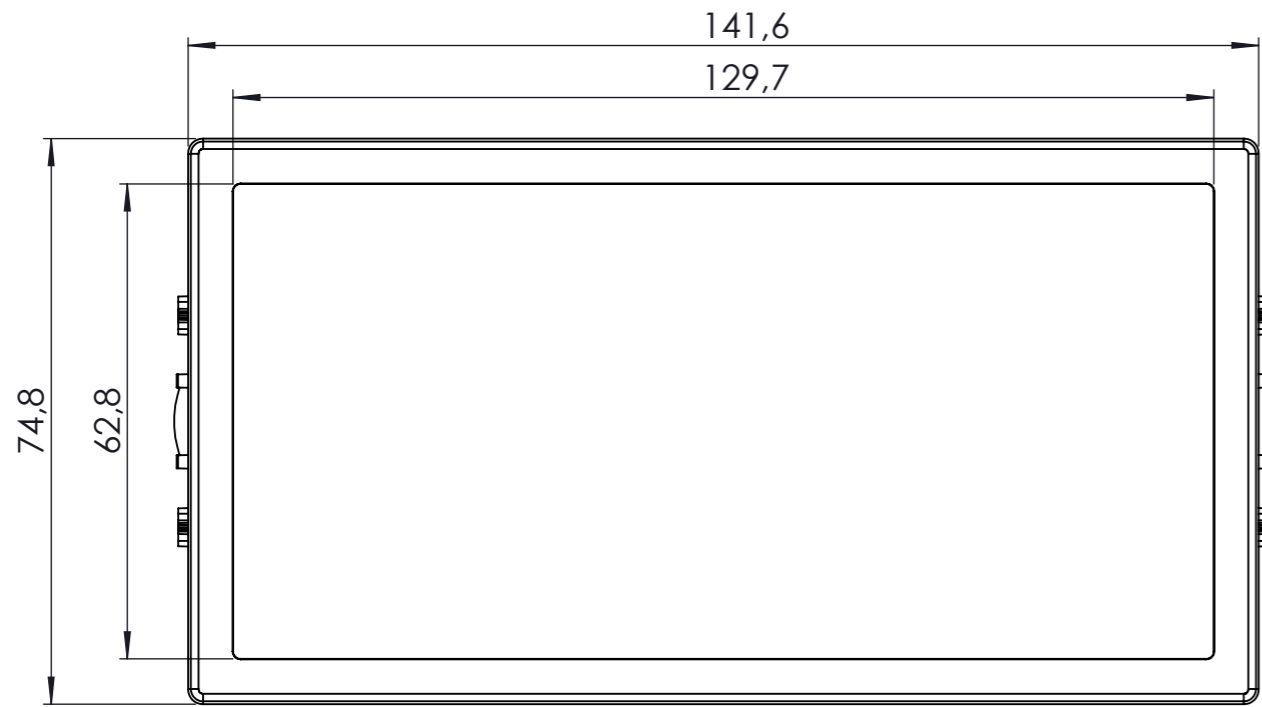

DİKKAT: BU RESİM VE ÜRÜN ÖNCEDEN HABER VERİLMEKSİZİN DEĞİŞTİREBİLİR. RESİM ÇİZİLİRKEN HATASIZ OLMASINA ÇALIŞILMASINA RAĞMEN RESİMDE HATALAR BULUNABİLİR. RESİMDEKİ HATALARDAN DOLAYI OLUŞABİLECEK ZARARLAR İÇİN ALTINKAYA HiÇ BİR SORUMLULUK KABUL ETMEZ. BÜTÜN ÖLÇÜLER KULLANILMADAN ÖNCE ÜRETİLMİŞ GERÇEK NUMUNEDEN KONTROL EDİLMELİDİR.

PROPRIETARY AND CONFIDENTIAL THE INFORMATION CONTAINED IN THIS DRAWING IS THE SOLE PROPERTY OF ALTINKAYA ENCLOSURES. ANY REPRODUCTION IN PART OR AS A WHOLE WITHOUT THE WRITTEN PERMISSION OF ALTINKAYA ENCLOSURES IS PROHIBITED.		ARTICLE NO:	REVISION:
DRAWN Dursun Daşdemir 10.05.23		CONTACT: www.altinkaya.com.tr	
CHECKED Ali Altınışık 10.05.23		TITLE: PT-208 Panel Tipi Kutu	
COMMENTS: This drawing is subject to technical modification without prior notice. Typographical and other errors do not justify any claims for damages. All dimensions should be verified using an actual produced part.		DWG NO: PT-208-0-0	A3
MATERIAL:		SCALE:1:1	SHEET 1 OF 1
WEIGHT:			

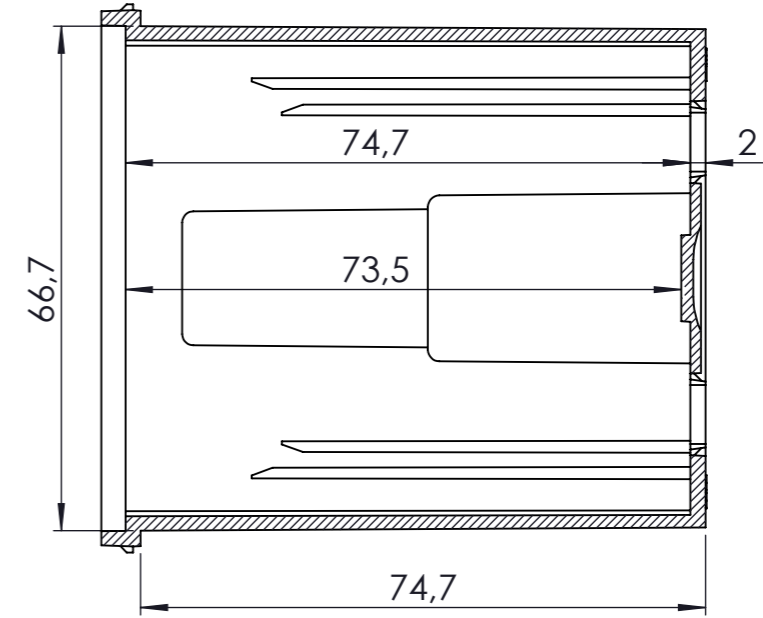
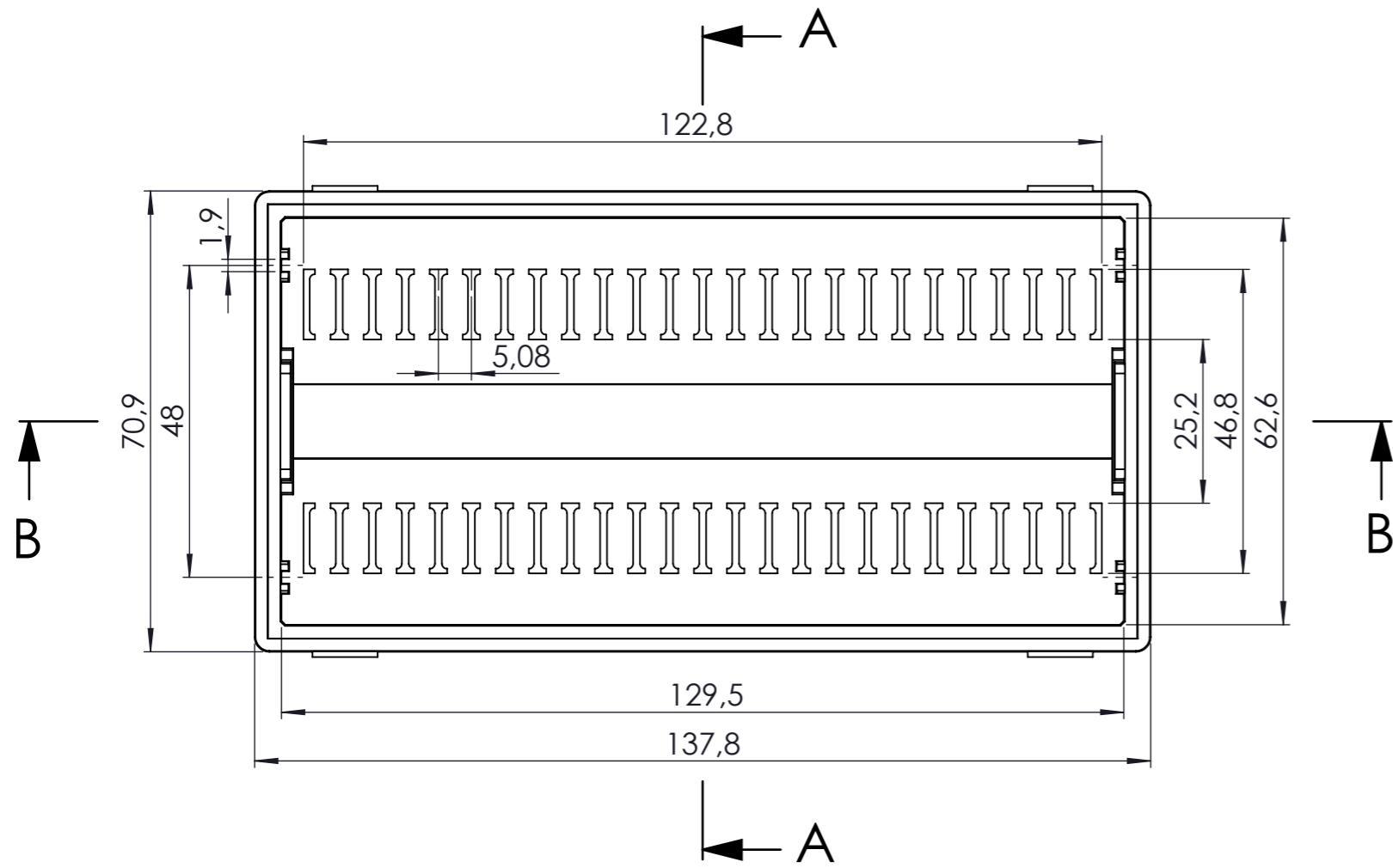

KESIT A-A

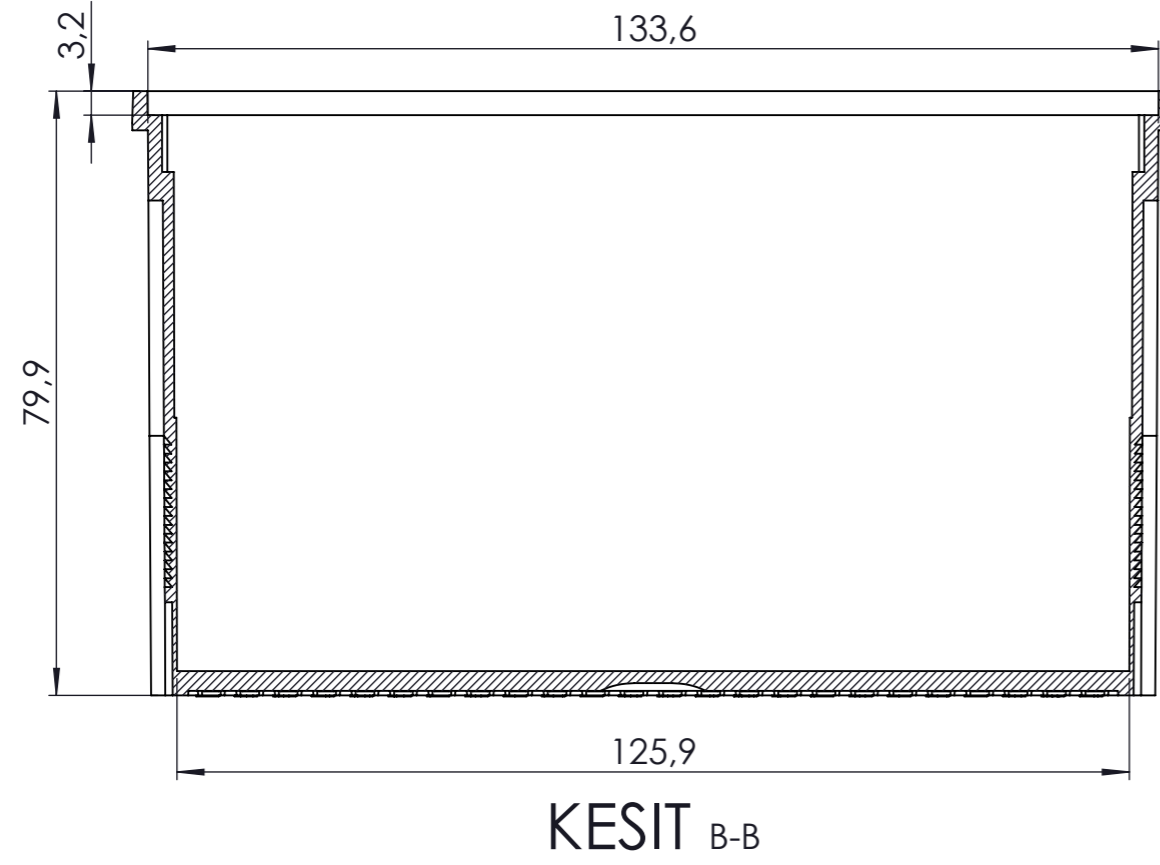

KESIT B-B

DİKKAT: BU RESİM VE ÜRÜN ÖNCEDEN HABER VERİLMEKSİZİN DEĞİŞTİREBİLİR. RESİM ÇİZİLİRKEN HATASIZ OLMASINA ÇALIŞILMASINA RAĞMEN RESİMDE HATALAR BULUNABİLİR. RESİMDEKİ HATALARDAN DOLAYI OLUŞABİLECEK ZARARLAR İÇİN ALTINKAYA HiÇ BİR SORUMLULUK KABUL ETMEZ. BÜTÜN ÖLÇÜLER KULLANILMADAN ÖNCE ÜRETİLMİŞ GERÇEK NUMUNEDEN KONTROL EDİLMELİDİR.

PROPRIETARY AND CONFIDENTIAL THE INFORMATION CONTAINED IN THIS DRAWING IS THE SOLE PROPERTY OF ALTINKAYA ENCLOSURES. ANY REPRODUCTION IN PART OR AS A WHOLE WITHOUT THE WRITTEN PERMISSION OF ALTINKAYA ENCLOSURES IS PROHIBITED.			ARTICLE NO:	REVISION:
DRAWN: Dursun Daşdemir 10.05.23 CHECKED: Ali Altınışık 10.05.23			 CONTACT: www.altinkaya.com.tr	TITLE:
COMMENTS: This drawing is subject to technical modification without prior notice. Typographical and other errors do not justify any claims for damages. All dimensions should be verified using an actual produced part.			PT-208-15 Gövde	
MATERIAL:			DWG NO:	A3
WEIGHT:			SCALE:1:1	SHEET 1 OF 1

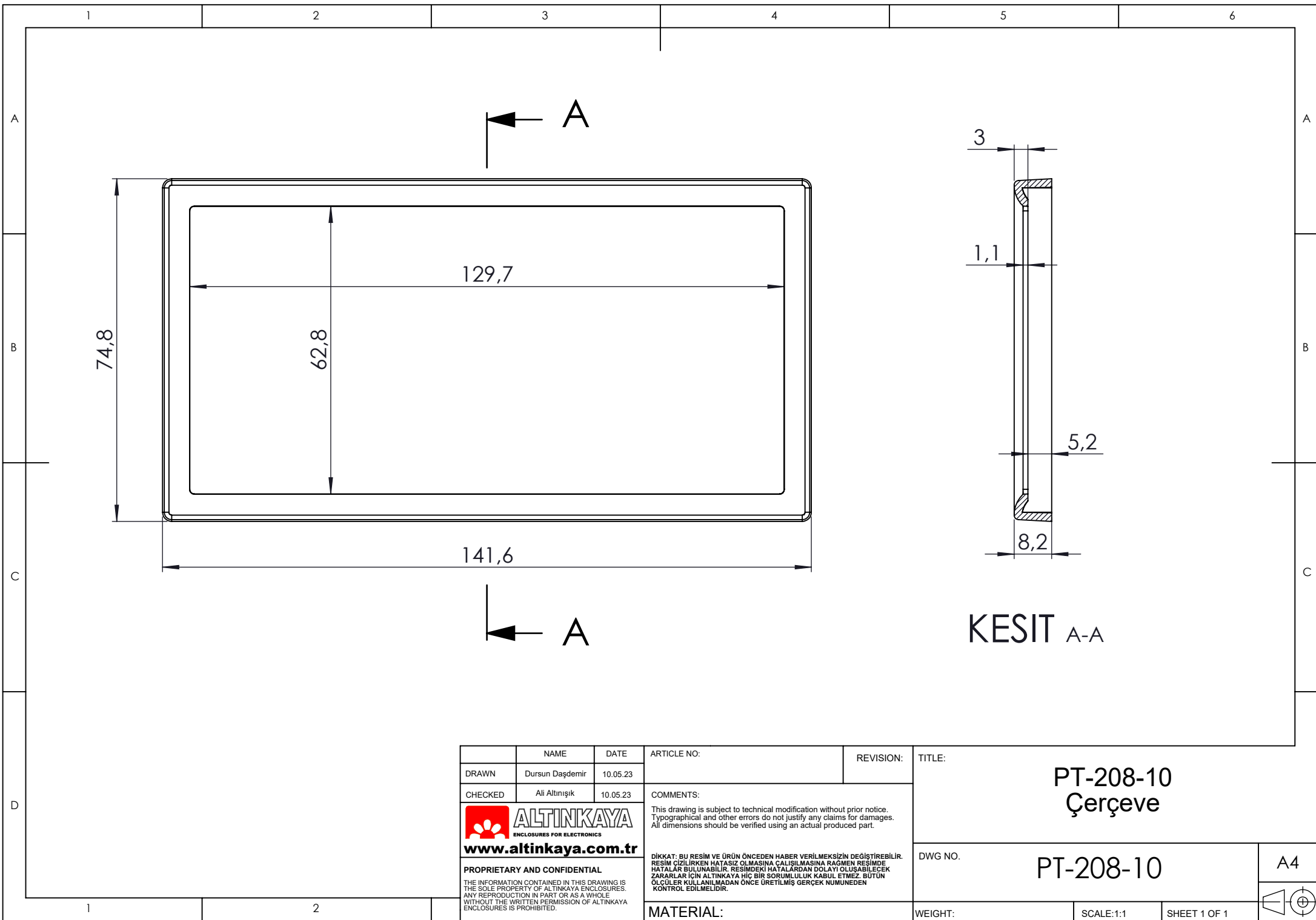

KESIT A-A

	NAME	DATE	ARTICLE NO:	REVISION:	TITLE:	
DRAWN	Dursun Daşdemir	10.05.23			PT-208-10 Çerçeve	
CHECKED	Ali Altınışık	10.05.23	COMMENTS:			
 www.altinkaya.com.tr			DİKKAT: BU RESİM VE ÜRÜN ÖNCEDEN HABER VERİLMEKSİZİN DEĞİŞTİREBİLİR. RESİM ÇİZİLRKEN HATASIZ OLMASINA ÇALIŞILMASINA RAĞMEN RESİMDE HATALAR BULUNABİLİR. RESİMDEKİ HATALARDAN DOLAYI OLUŞABİLECEK ZARARLAR İÇİN ALTINKAYA HİÇ BİR SORUMLULUK KABUL ETMEZ. BÜTÜN ÖLÇÜLER KULLANILMADAN ÖNCE ÜRETİLMİŞ GERÇEK NUMUNEDEN KONTROL EDİLMELİDİR.		DWG NO:	A4
PROPRIETARY AND CONFIDENTIAL THE INFORMATION CONTAINED IN THIS DRAWING IS THE SOLE PROPERTY OF ALTINKAYA ENCLOSURES. ANY REPRODUCTION IN PART OR AS A WHOLE WITHOUT THE WRITTEN PERMISSION OF ALTINKAYA ENCLOSURES IS PROHIBITED.			MATERIAL:	WEIGHT:	SCALE:1:1	SHEET 1 OF 1

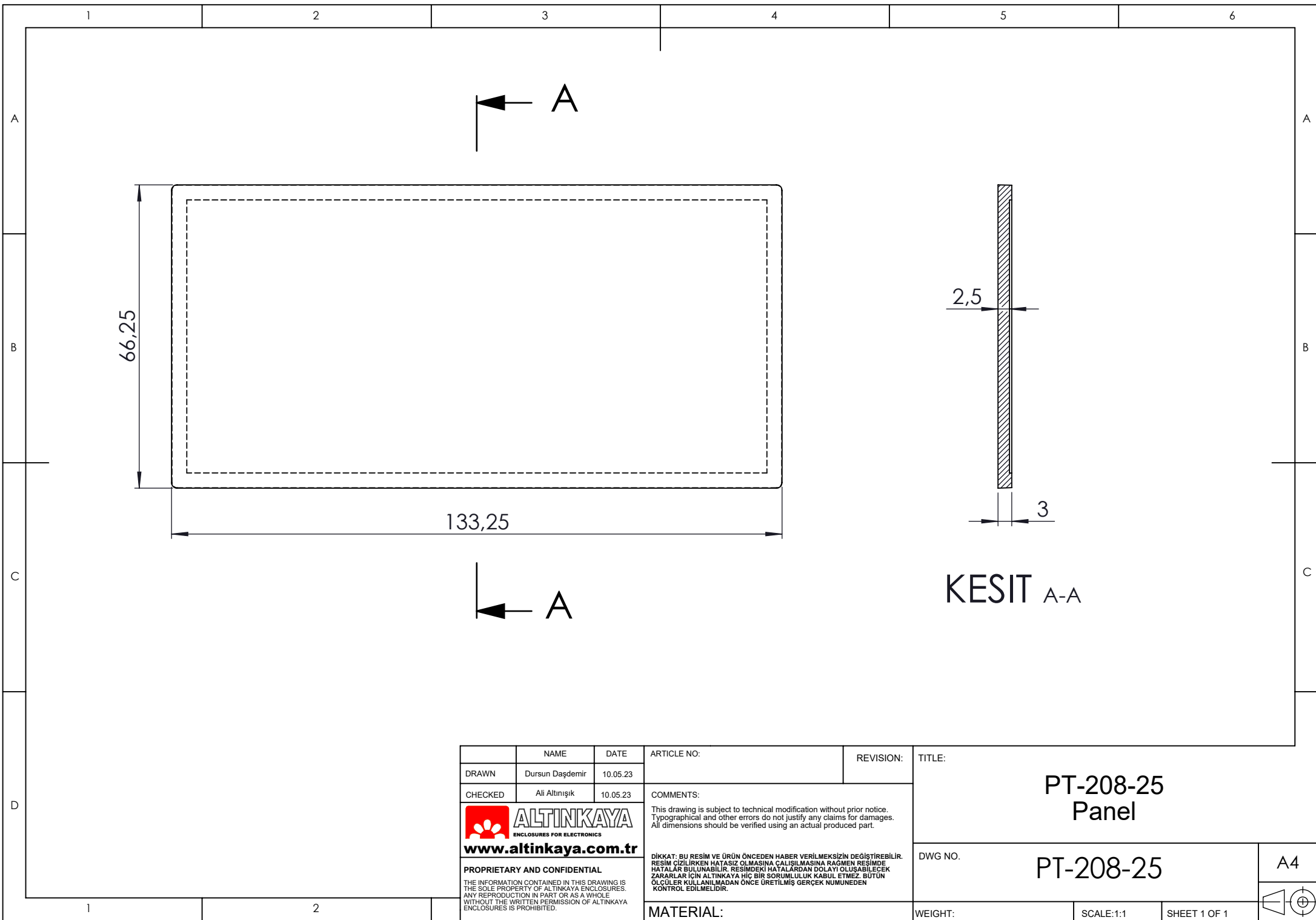

	NAME	DATE	ARTICLE NO:	REVISION:	TITLE:	
DRAWN	Dursun Daşdemir	10.05.23			PT-208-25 Panel	
CHECKED	Ali Altınışık	10.05.23	COMMENTS:			
 www.altinkaya.com.tr			DİKKAT: BU RESİM VE ÜRÜN ÖNCEDEN HABER VERİLMEKSİZİN DEĞİŞTİREBİLİR. RESİM ÇİZİLRKEN HATASIZ OLMASINA ÇALIŞILMASINA RAĞMEN RESİMDE HATALAR BULUNABİLİR. RESİMDEKİ HATALARDAN DOLAYI OLUŞABİLECEK ZARARLAR İÇİN ALTINKAYA HİÇ BİR SORUMLULUK KABUL ETMEZ. BÜTÜN ÖLÇÜLER KULLANILMADAN ÖNCE ÜRETİLMİŞ GERÇEK NUMUNEDEN KONTROL EDİLMELİDİR.		DWG NO:	A4
PROPRIETARY AND CONFIDENTIAL THE INFORMATION CONTAINED IN THIS DRAWING IS THE SOLE PROPERTY OF ALTINKAYA ENCLOSURES. ANY REPRODUCTION IN PART OR AS A WHOLE WITHOUT THE WRITTEN PERMISSION OF ALTINKAYA ENCLOSURES IS PROHIBITED.			MATERIAL:	WEIGHT:	SCALE:1:1	SHEET 1 OF 1

