

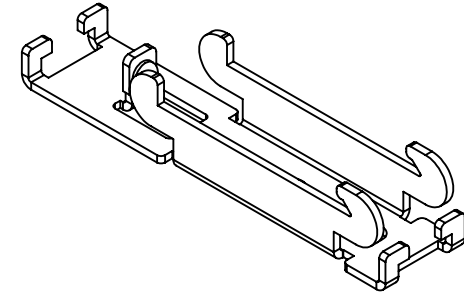

KESİT A-A

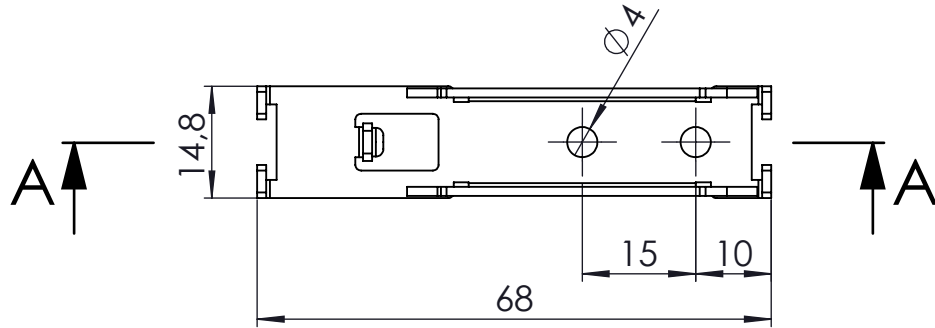



NAME	DATE	ARTICLE NO:	REVISION:	TITLE:
DRAWN	Dursun Dağdemir	19.11.20		Alt Gövde
CHECKED	Ali Altınışık	19.11.20		
 www.altinkaya.com.tr			COMMENTS: This drawing is subject to technical modification without prior notice. Typographical and other errors do not justify any claims for damages. All dimensions should be verified using an actual produced part.	
PROPRIETARY AND CONFIDENTIAL THE INFORMATION CONTAINED IN THIS DRAWING IS THE SOLE PROPERTY OF ALTINKAYA ENCLOSURES. ANY REPRODUCTION IN PART OR AS A WHOLE WITHOUT THE WRITTEN PERMISSION OF ALTINKAYA ENCLOSURES IS PROHIBITED.			DWG NO. A-115-P-1	
MATERIAL:			WEIGHT:	SCALE:1:1
			SHEET 1 OF 1	

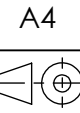
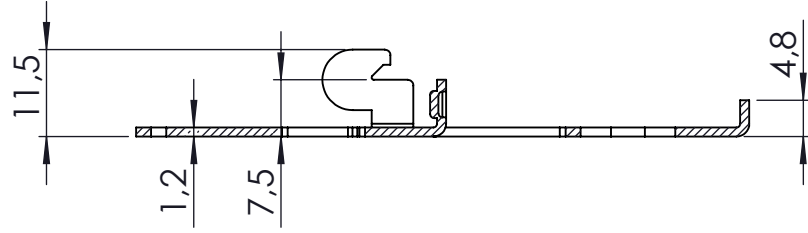

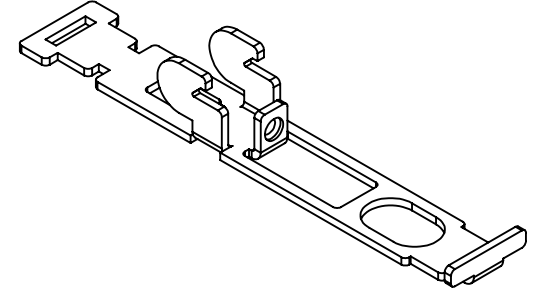
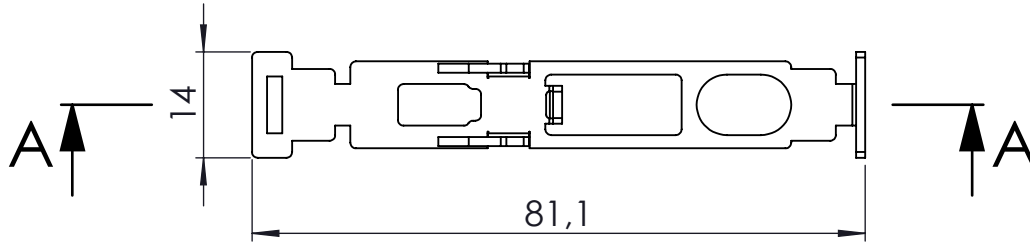

KESİT A-A



NAME	DATE	ARTICLE NO:	REVISION:	TITLE:
DRAWN Dursun Daşdemir	19.11.20			Çubuk
CHECKED Ali Altınışık	19.11.20	COMMENTS:		
 ALTINKAYA ENCLOSURES FOR ELECTRONICS www.altinkaya.com.tr		<p>DİKKAT: BU RESİM VE ÜRÜN ÖNCEDEN HABER VERİLMEKSİZİN DEĞİŞTİREBİLİR. RESİM ÇİZİLRKEN HATASIZ OLMASINA ÇALIŞILMASINA RAĞMEN RESİMDE HATALAR BULUNABİLİR. RESİMDEKİ HATALARDAN DOLAYI OLUŞABİLECEK ZARARLAR İÇİN ALTINKAYA HİÇ BİR SORUMLULUK KABUL ETMEZ. BÜTÜN ÖLÇÜLER KULLANILMADAN ÖNCE ÜRETİLMİŞ GERÇEK NUMUNEDEN KONTROL EDİLMELİDİR.</p>		DWG NO:
<small>THE INFORMATION CONTAINED IN THIS DRAWING IS THE SOLE PROPERTY OF ALTINKAYA ENCLOSURES. ANY REPRODUCTION IN PART OR AS A WHOLE WITHOUT THE WRITTEN PERMISSION OF ALTINKAYA ENCLOSURES IS PROHIBITED.</small>		MATERIAL:		A4
		WEIGHT:		SCALE:1:1
				SHEET 1 OF 1

