





DETAIL A  
SCALE 1 : 2

	NAME	DATE	ARTICLE NO:	REVISION:	TITLE:
DRAWN	Dursun CAN				
CHECKED	Ali Altınışık		COMMENTS:		
 <b>ALTINKAYA</b> ENCLOSURES FOR ELECTRONICS <a href="http://www.altinkaya.com.tr">www.altinkaya.com.tr</a>			DIMENSIONS ARE IN MILLIMETERS. DEBUR AND BREAK SHARP EDGES		
PROPRIETARY AND CONFIDENTIAL <small>THE INFORMATION CONTAINED IN THIS DRAWING IS THE SOLE PROPERTY OF ALTINKAYA ENCLOSURES. ANY REPRODUCTION IN PART OR AS A WHOLE WITHOUT THE WRITTEN PERMISSION OF ALTINKAYA ENCLOSURES IS PROHIBITED.</small>			MATERIAL:	WEIGHT:	DWG NO. DE-170-Montaj
				SCALE:1:5	A4
				SHEET 1 OF 1	

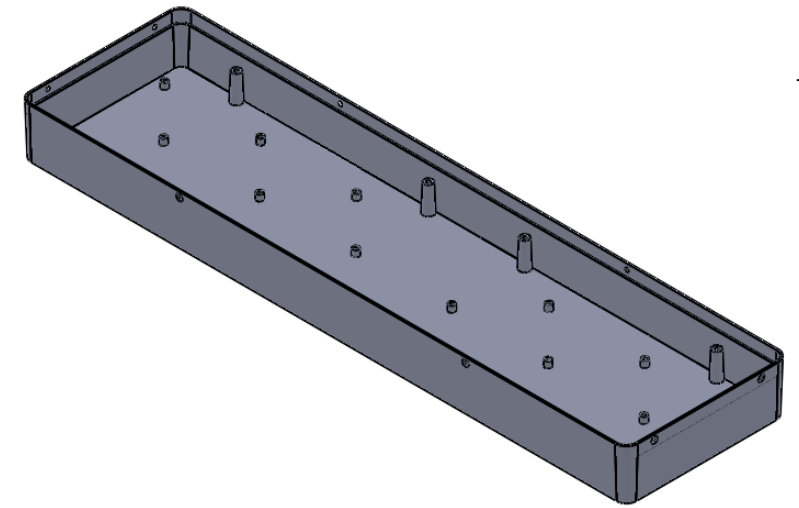
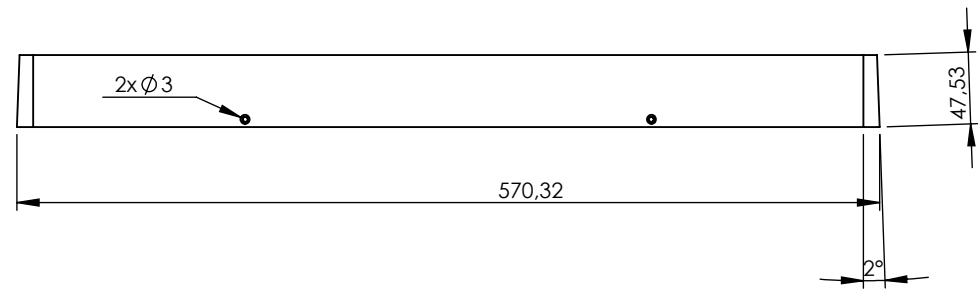
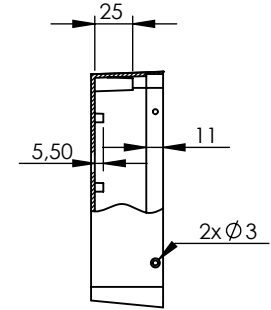
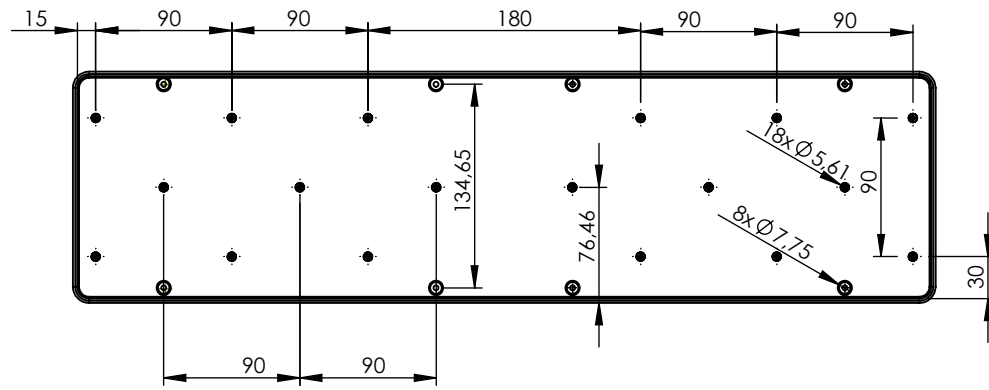

	NAME	DATE	ARTICLE NO:	REVISION:	TITLE:
DRAWN	Dursun CAN				
CHECKED	Ali Altınışık		COMMENTS: DIMENSIONS ARE IN MILLIMETERS. DEBUR AND BREAK SHARP EDGES		
 <b>ALTINKAYA</b> ENCLOSURES FOR ELECTRONICS <a href="http://www.altinkaya.com.tr">www.altinkaya.com.tr</a>			DWG NO.		DE-170-Govde
PROPRIETARY AND CONFIDENTIAL THE INFORMATION CONTAINED IN THIS DRAWING IS THE SOLE PROPERTY OF ALTINKAYA ENCLOSURES. ANY REPRODUCTION IN PART OR AS A WHOLE WITHOUT THE WRITTEN PERMISSION OF ALTINKAYA ENCLOSURES IS PROHIBITED.			A4		
MATERIAL:			WEIGHT:	SCALE:1:5	SHEET 1 OF 1



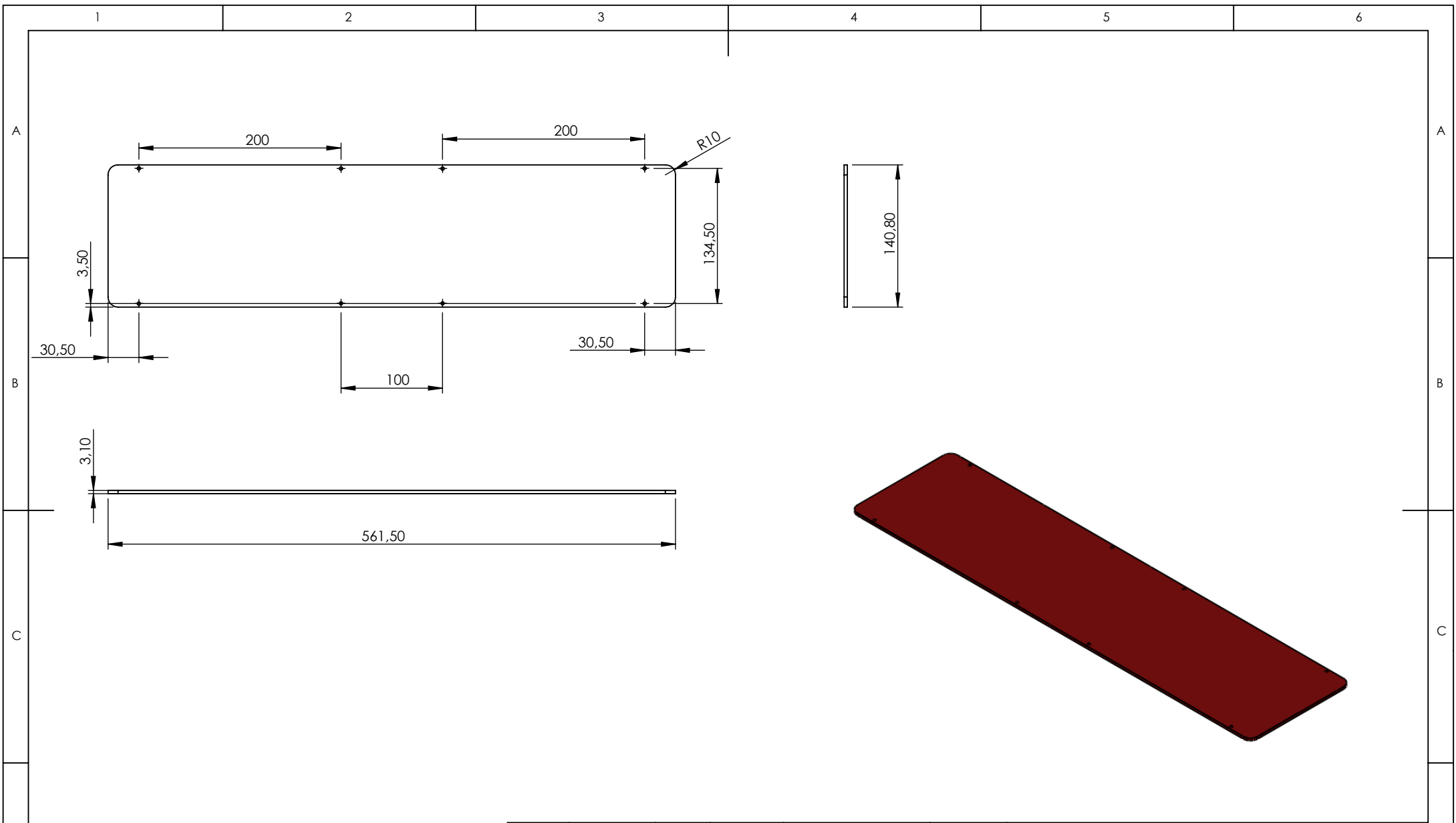

	NAME	DATE	ARTICLE NO:	REVISION:	TITLE:
DRAWN	Dursun CAN				
CHECKED	Ali Altınışık		COMMENTS:		
 <b>ALTINKAYA</b> ENCLOSURES FOR ELECTRONICS <a href="http://www.altinkaya.com.tr">www.altinkaya.com.tr</a>			DIMENSIONS ARE IN MILLIMETERS. DEBUR AND BREAK SHARP EDGES		
<b>PROPRIETARY AND CONFIDENTIAL</b> <small>THE INFORMATION CONTAINED IN THIS DRAWING IS THE SOLE PROPERTY OF ALTINKAYA ENCLOSURES. ANY REPRODUCTION IN PART OR AS A WHOLE WITHOUT THE WRITTEN PERMISSION OF ALTINKAYA ENCLOSURES IS PROHIBITED.</small>			DWG NO. <b>DE-170-Cam</b>		A4
			MATERIAL:	WEIGHT:	SCALE:1:5
			SHEET 1 OF 1		

