

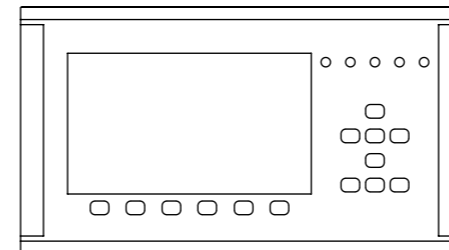

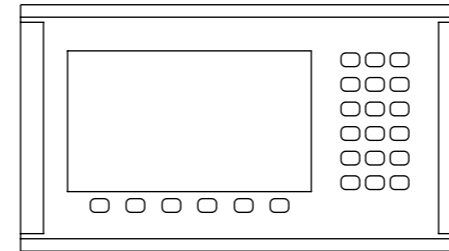

Örnek Paneller

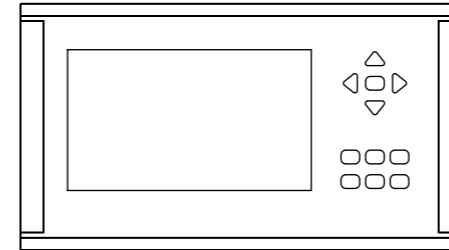
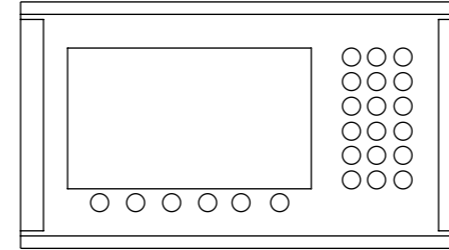

PROPRIETARY AND CONFIDENTIAL <small>THE INFORMATION CONTAINED IN THIS DRAWING IS THE SOLE PROPERTY OF ALTINKAYA ENCLOSURES. ANY REPRODUCTION IN PART OR AS A WHOLE WITHOUT THE WRITTEN PERMISSION OF ALTINKAYA ENCLOSURES IS PROHIBITED.</small>		ARTICLE NO:	REVISION:
DRAWN: Dursun Daşdemir DATE: 31.07.08		 ALTINKAYA ENCLOSURES FOR ELECTRONICS CONTACT: www.altinkaya.com.tr	
CHECKED: Ali Altınışık DATE: 31.07.08		TITLE: OP-100 Operatör Paneli	
COMMENTS: DIMENSIONS ARE IN MILLIMETRES, DEBUR AND BREAK SHARP EDGES		DWG NO:	
MATERIAL:		A3	
WEIGHT:		SCALE: 1:2	
		SHEET 1 OF 1	

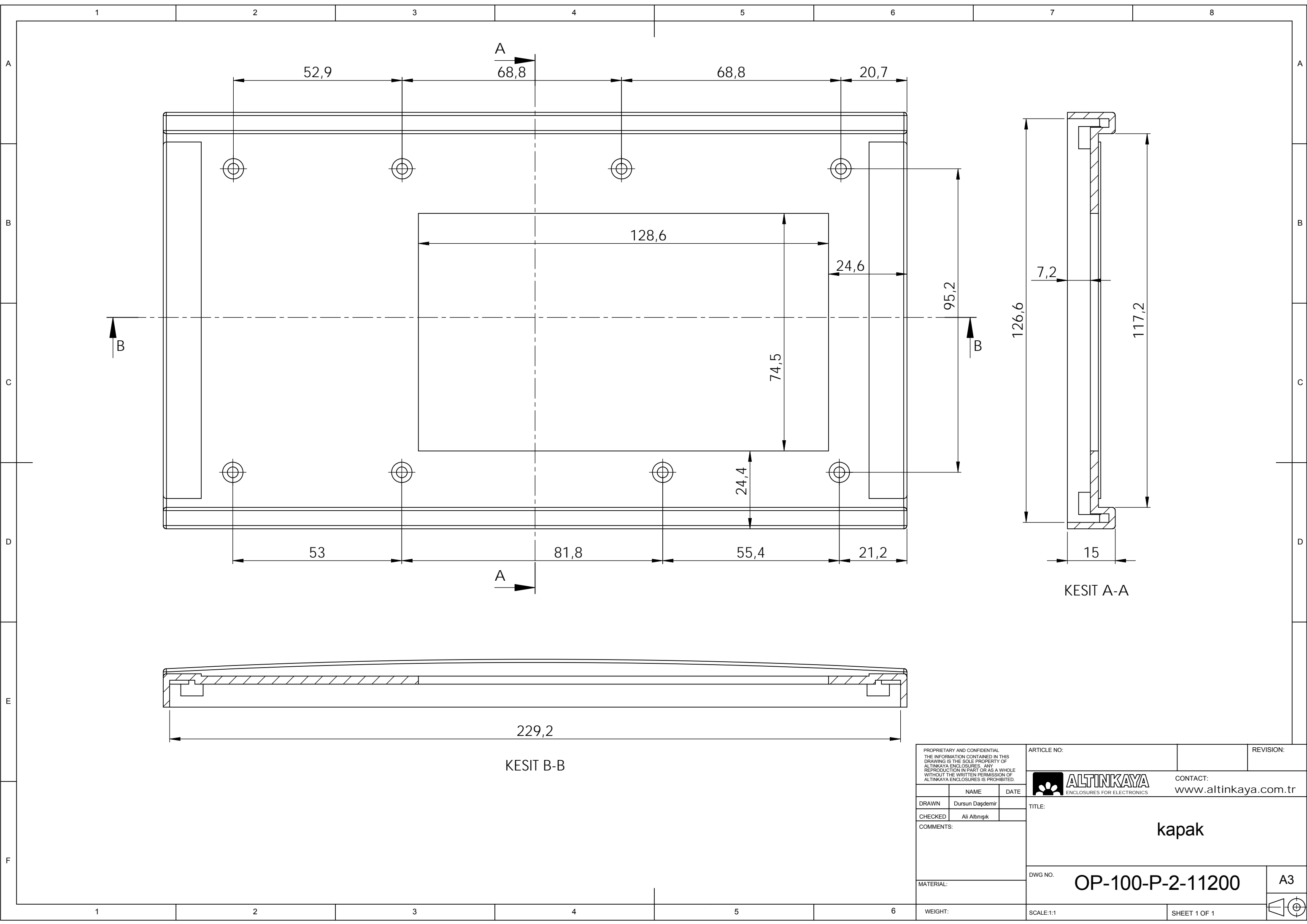

<small>PROPRIETARY AND CONFIDENTIAL. THE INFORMATION CONTAINED IN THIS DRAWING IS THE SOLE PROPERTY OF ALTINKAYA ENCLOSURES. ANY REPRODUCTION IN PART OR AS A WHOLE WITHOUT THE WRITTEN PERMISSION OF ALTINKAYA ENCLOSURES IS PROHIBITED.</small>		ARTICLE NO.:	REVISION:						
<table border="1"> <tr> <th>NAME</th> <th>DATE</th> </tr> <tr> <td>Dursun Daşdemir</td> <td></td> </tr> <tr> <td>Ali Altınışık</td> <td></td> </tr> </table>		NAME	DATE	Dursun Daşdemir		Ali Altınışık			CONTACT: www.altinkaya.com.tr
NAME	DATE								
Dursun Daşdemir									
Ali Altınışık									
<table border="1"> <tr> <th>DRAWN</th> <th>CHECKED</th> </tr> <tr> <td>Dursun Daşdemir</td> <td>Ali Altınışık</td> </tr> </table>		DRAWN	CHECKED	Dursun Daşdemir	Ali Altınışık	TITLE: kapak			
DRAWN	CHECKED								
Dursun Daşdemir	Ali Altınışık								
MATERIAL:		DWG NO. OP-100-P-2-11200	A3						
WEIGHT:		SCALE:1:1	SHEET 1 OF 1						