

KESIT A-A

Pcb Sample

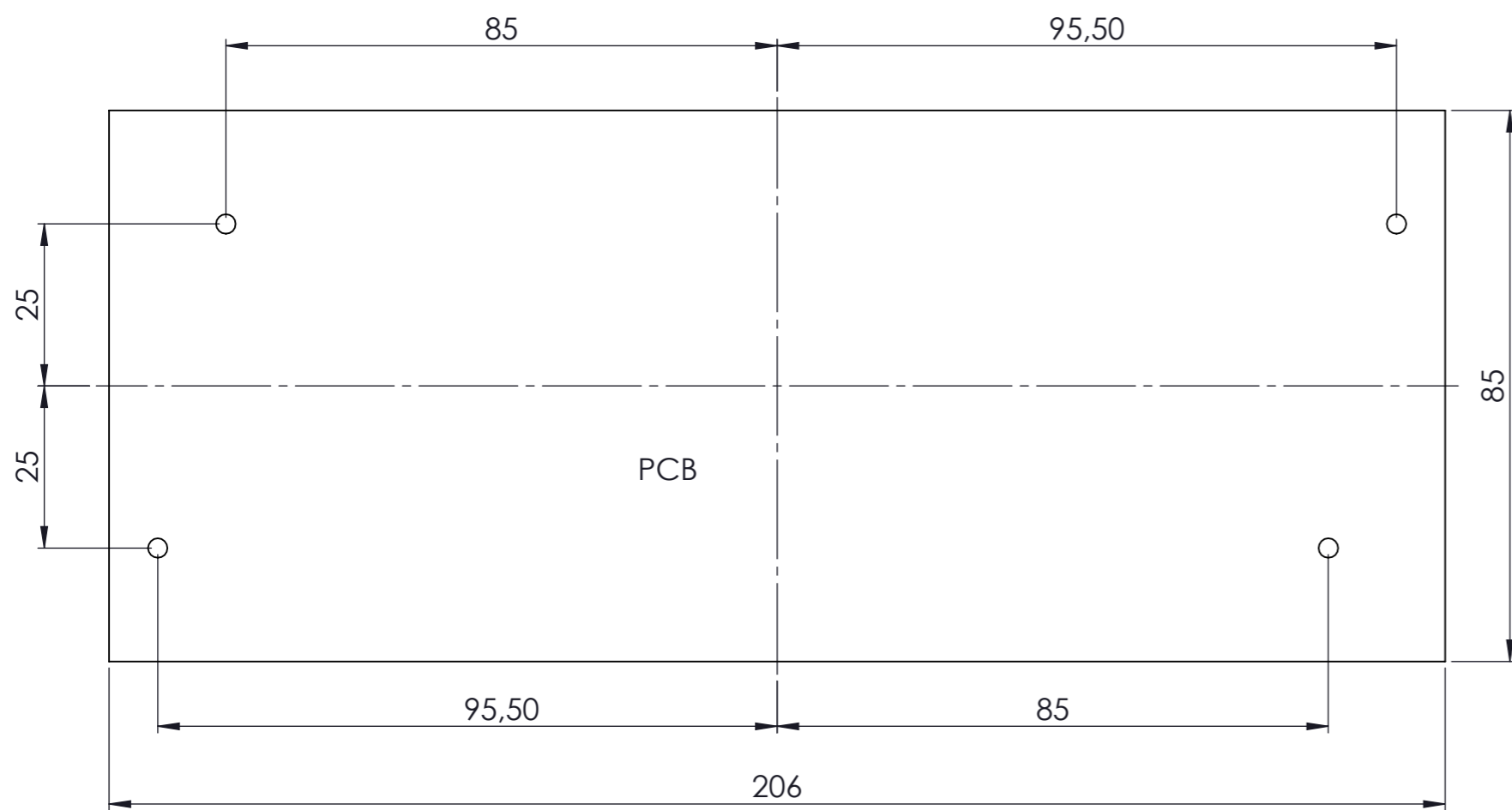

PCB

DİKKAT: BU RESİM VE ÜRÜN ÖNCEDEN HABER VERİLMEKSİZİN DEĞİŞTİREBİLİR. RESİM ÇİZİLMESİNİN HATASIZ OLMASINA ÇALIŞILMASINA RAĞMEN RESİMDEKİ HATALARDAN DOLAYI OLUŞABİLECEK ZARARLAR İÇİN ALTINKAYA HIÇ BİR SORUMLULUK KABUL ETMEZ. BÜTÜN ÖLÇÜLER KULLANILMADAN ÖNCE ÜRETİLMİŞ GERÇEK NUMUNEDEN KONTROL EDİLMELİDİR.

<small>PROPRIETARY AND CONFIDENTIAL. THE INFORMATION CONTAINED IN THIS DRAWING IS THE SOLE PROPERTY OF ALTINKAYA ENCLOSURES. ANY REPRODUCTION IN PART OR AS A WHOLE WITHOUT THE WRITTEN PERMISSION OF ALTINKAYA ENCLOSURES IS PROHIBITED.</small>			ARTICLE NO:	REVISION:
<small>ALTINKAYA ENCLOSURES FOR ELECTRONICS</small>			CONTACT: www.altinkaya.com.tr	
DRAWN	Dursun Daşdemir	16.05.17	TITLE: RT-212 12 Modül Ray Tipi Kutu	
CHECKED	Ali Altınışık	16.05.17	DWG NO: RT-212-0-0	
<small>COMMENTS: This drawing is subject to technical modification without prior notice. Typographical and other errors do not justify any claims for damages. All dimensions should be verified using an actual produced part.</small>			A3	
MATERIAL:			SCALE:1:1	
WEIGHT:			SHEET 1 OF 1	

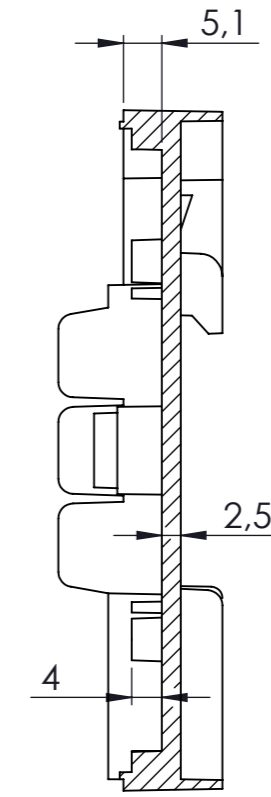
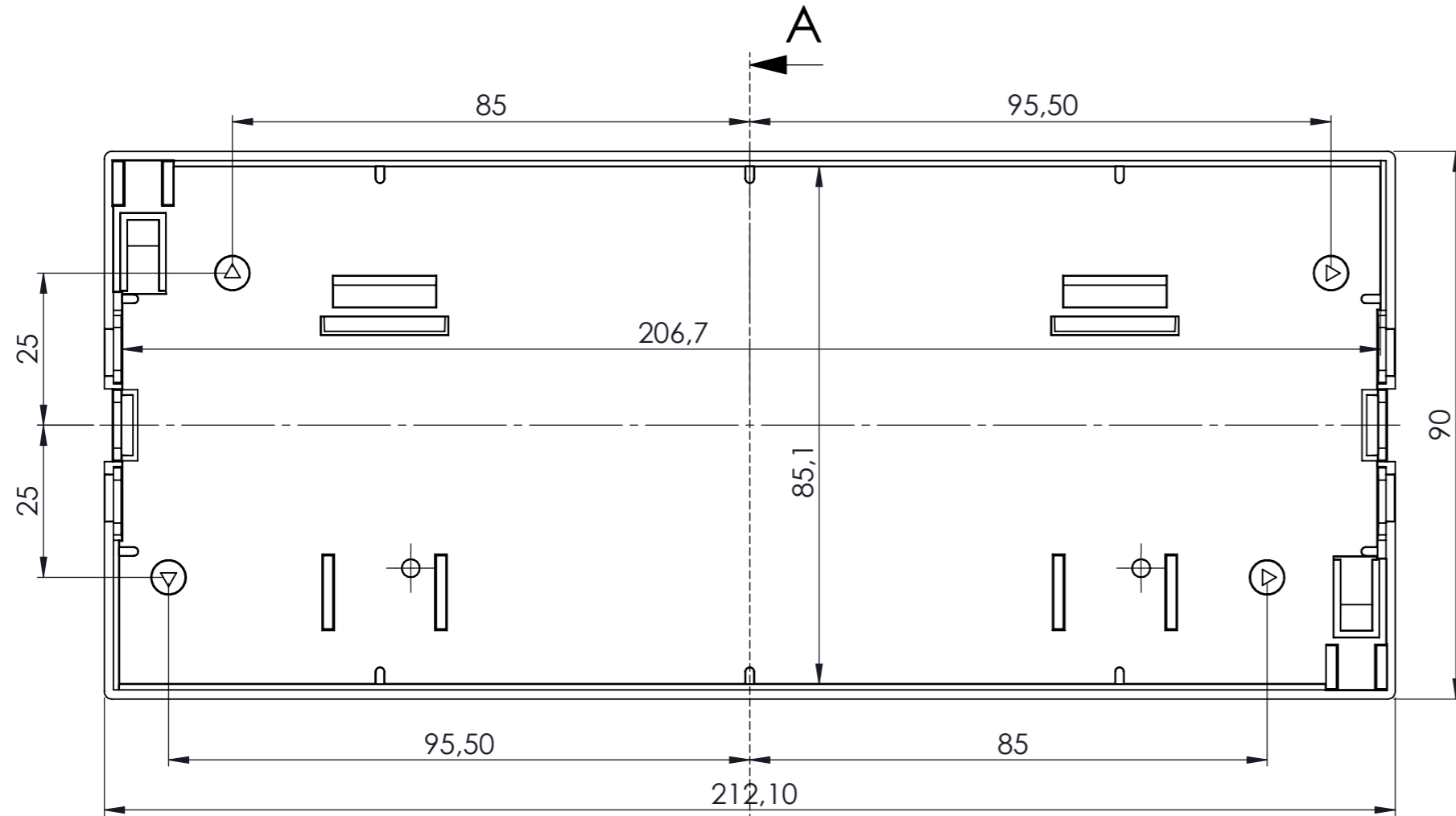

KESİT A-A

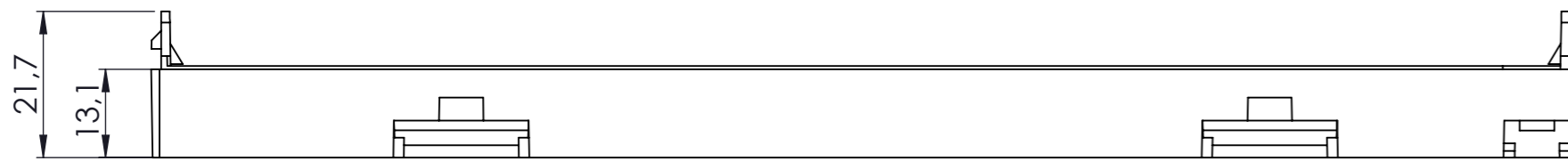

DİKKAT: BU RESİM VE ÜRÜN ÖNCEDEN HABER VERİLMEKSİZİN DEĞİŞTİREBİLİR. RESİM ÇİZİLMESİNİN HATASIZ OLMASINA ÇALIŞILMASINA RAĞMEN RESİMDEKİ HATALAR BULUNABİLİR. RESİMDEKİ HATALARDAN DOLAYI OLUŞABİLECEK ZARARLAR İÇİN ALTINKAYA HiÇ BİR SORUMLULUK KABUL ETMEZ. BÜTÜN ÖLÇÜLER KULLANILMADAN ÖNCE ÜRETİLMİŞ GERÇEK NUMUNEDEN KONTROL EDİLMELİDİR.

<small>PROPRIETARY AND CONFIDENTIAL THE INFORMATION CONTAINED IN THIS DRAWING IS THE SOLE PROPERTY OF ALTINKAYA ENCLOSURES. ANY REPRODUCTION IN PART OR AS A WHOLE WITHOUT THE WRITTEN PERMISSION OF ALTINKAYA ENCLOSURES IS PROHIBITED.</small>			ARTICLE NO:	REVISION:
<small>DRAWN</small> Dursun Daşdemir 16.05.17 <small>CHECKED</small> Ali Altınışık 16.05.17			 ENCLOSURES FOR ELECTRONICS	CONTACT: www.altinkaya.com.tr
<small>COMMENTS: This drawing is subject to technical modification without prior notice. Typographical and other errors do not justify any claims for damages. All dimensions should be verified using an actual produced part.</small>			TITLE: RT-212 Taban	
MATERIAL:			DWG NO: RT-212-P-1	A3
WEIGHT:			SCALE:1:1	SHEET 1 OF 1

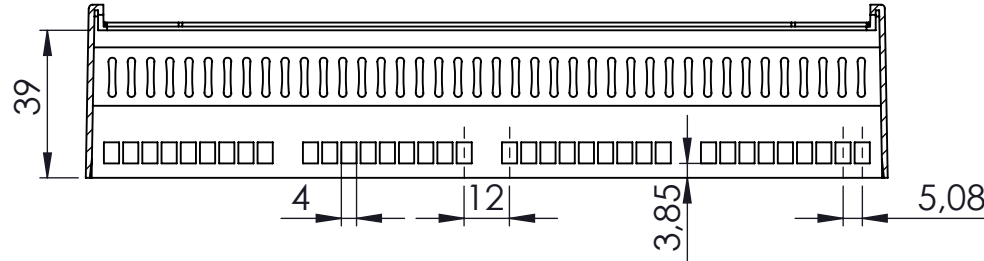
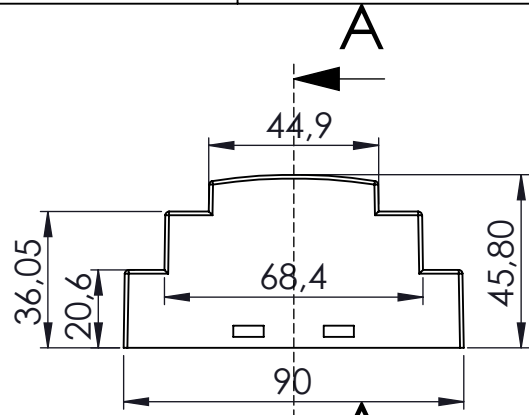

KESİT A-A

RT-212-C

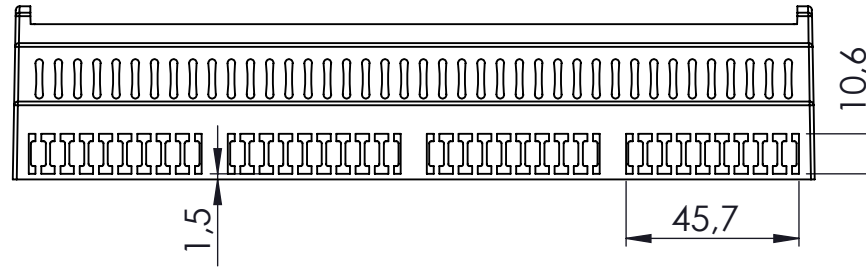
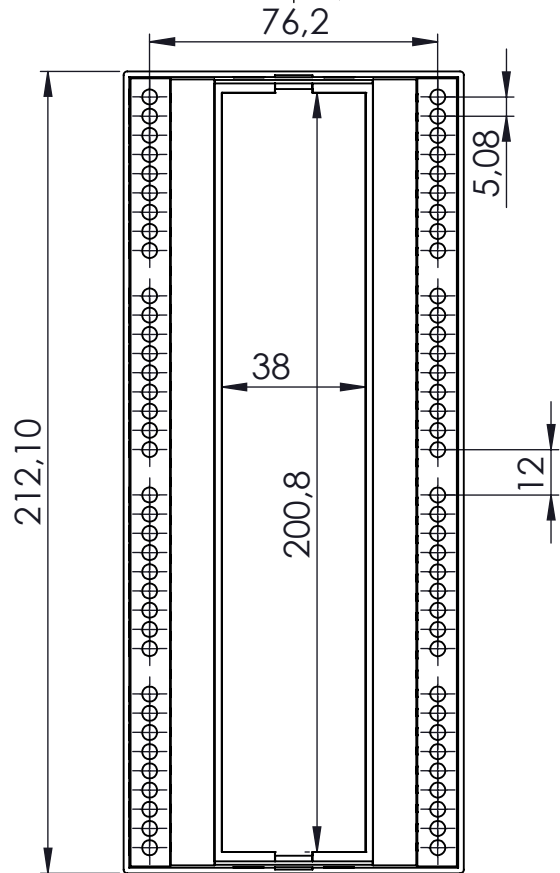

RT-212-D

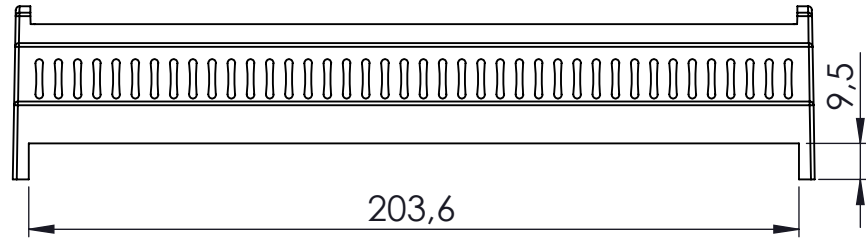

RT-212-E

NAME	DATE	ARTICLE NO:	REVISION:	TITLE:
DRAWN Dursun Dağdemir	16.05.17			RT-212 Gövde
CHECKED Ali Altınışık	16.05.17	COMMENTS:		
 ENCLOSURES FOR ELECTRONICS www.altinkaya.com.tr		DİKKAT: BU RESİM VE ÜRÜN ÖNCEDEN HABER VERİLMEKSİZİN DEĞİŞTİREBİLİR. RESİM ÇİZİLRKEN HATASIZ OLMASINA ÇALIŞILMASINA RAĞMEN RESİMDE HATALAR BULUNABİLİR. RESİMDEKİ HATALARDAN DOLAYI OLUŞABİLECEK ZARARLAR İÇİN ALTINKAYA HİÇ BİR SORUMLULUK KABUL ETMEZ. BÜTÜN ÖLÇÜLER KULLANILMADAN ÖNCE ÜRETİLMİŞ GERÇEK NUMUNEDEN KONTROL EDİLMELİDİR.		DWG NO.
PROPRIETARY AND CONFIDENTIAL THE INFORMATION CONTAINED IN THIS DRAWING IS THE SOLE PROPERTY OF ALTINKAYA ENCLOSURES. ANY REPRODUCTION IN PART OR AS A WHOLE WITHOUT THE WRITTEN PERMISSION OF ALTINKAYA ENCLOSURES IS PROHIBITED.		MATERIAL:		RT-212-P-2
		WEIGHT:		A4
		SCALE:1:2		SHEET 1 OF 1



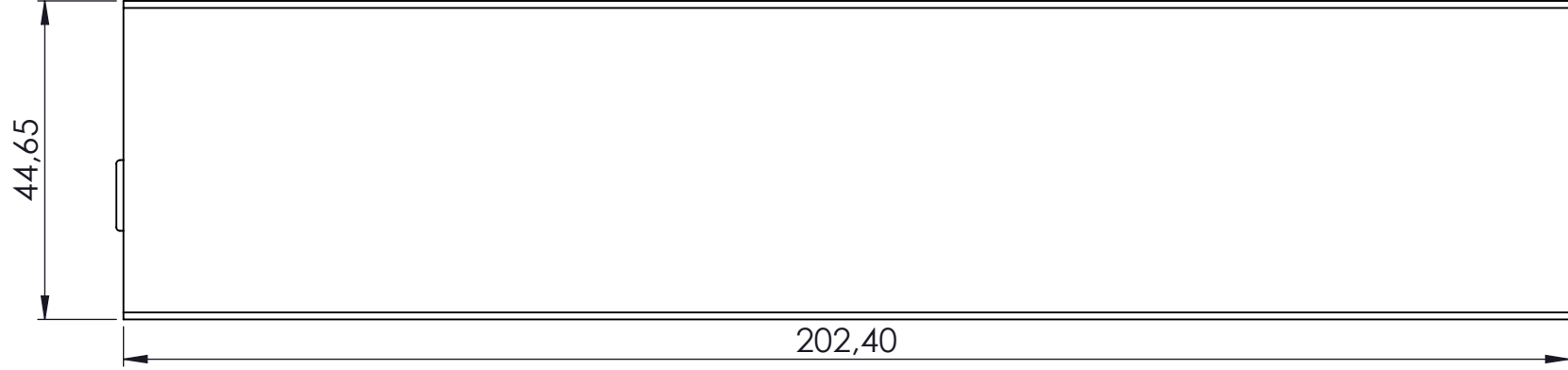

NAME	DATE	ARTICLE NO:	REVISION:	TITLE:
Dursun Dağdemir	16.05.17			RT-212 Ön Panel
Ali Altınışık	16.05.17			
 ALTINKAYA ENCLOSURES FOR ELECTRONICS www.altinkaya.com.tr		COMMENTS: This drawing is subject to technical modification without prior notice. Typographical and other errors do not justify any claims for damages. All dimensions should be verified using an actual produced part.		RT-212-25 A4
PROPRIETARY AND CONFIDENTIAL THE INFORMATION CONTAINED IN THIS DRAWING IS THE SOLE PROPERTY OF ALTINKAYA ENCLOSURES. ANY REPRODUCTION IN PART OR AS A WHOLE WITHOUT THE WRITTEN PERMISSION OF ALTINKAYA ENCLOSURES IS PROHIBITED.		DİKKAT: BU RESİM VE ÜRÜN ÖNCEDEN HABER VERİLMEKSİZİN DEĞİŞTİREBİLİR. RESİM ÇİZİLRKEN HATASIZ OLMASINA ÇALIŞILMASINA RAĞMEN RESİMDE HATALAR BULUNABİLİR. RESİMDEKİ HATALARDAN DOLAYI OLUŞABİLECEK ZARARLAR İÇİN ALTINKAYA HİÇ BİR SORUMLULUK KABUL ETMEZ. BÜTÜN ÖLÇÜLER KULLANILMADAN ÖNCE ÜRETİLMİŞ GERÇEK NUMUNEDEN KONTROL EDİLMELİDİR.		
MATERIAL:		WEIGHT:		SCALE:1:1
				SHEET 1 OF 1

